

GARMIN®

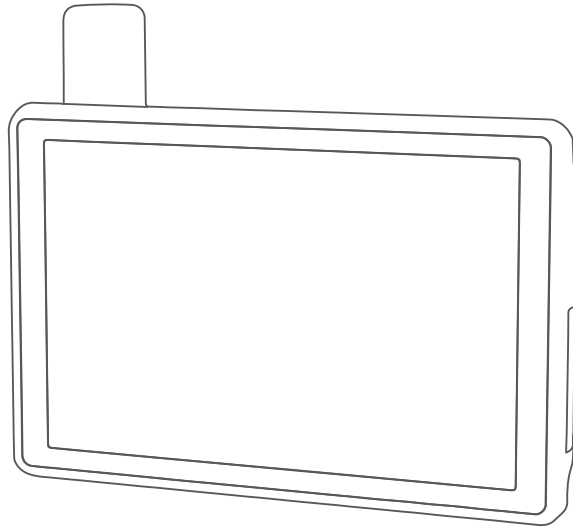

TREAD® XL - BAJA RACE EDITION
TREAD XL - BAJA CHASE EDITION

Owner's Manual

© 2022 Garmin Ltd. or its subsidiaries

All rights reserved. Under the copyright laws, this manual may not be copied, in whole or in part, without the written consent of Garmin. Garmin reserves the right to change or improve its products and to make changes in the content of this manual without obligation to notify any person or organization of such changes or improvements. Go to www.garmin.com for current updates and supplemental information concerning the use of this product.

Garmin®, the Garmin logo, inReach®, TracBack®, and Tread® are trademarks of Garmin Ltd. or its subsidiaries, registered in the USA and other countries. BaseCamp™, Garmin Adventurous Routing™, Garmin Drive™, Garmin Explore™, Garmin Express™, Garmin PowerSwitch™, Garmin Response™, and myTrends™ are trademarks of Garmin Ltd. or its subsidiaries. These trademarks may not be used without the express permission of Garmin.

Android™ is a trademark of Google Inc. Apple® and Mac® are trademarks of Apple Inc., registered in the U.S. and other countries. The BLUETOOTH® word mark and logos are owned by the Bluetooth SIG, Inc., and any use of such name by Garmin is under license. iOverlander™ is a trademark of iOverlander. Iridium® is a registered trademark of Iridium Satellite LLC. microSD® and the microSD logo are trademarks of SD-3C, LLC. Tripadvisor® is a registered trademark of Tripadvisor LLC. Windows® is a registered trademark of Microsoft Corporation in the United States and other countries. Wi-Fi® is a registered trademark of Wi-Fi Alliance. Other trademarks and trade names are those of their respective owners.

Table of Contents

Getting Started.....	1	Locking and Unlocking the Touchscreen.....	17
Setting Up Your Device.....	1	Off-Road Navigation Features.....	18
Device Overview.....	1	Routes.....	18
Tread XL Dock Overview.....	2	Adventure Roads and Trails.....	18
Turning the Device On or Off.....	4	Straight Line Routes.....	19
Acquiring GPS Signals.....	4	Stopping the Route.....	19
Status Bar Icons.....	5	Tracks.....	19
Using the Touchscreen.....	5	Recording Tracks.....	19
Using the On-Screen Buttons.....	5	Splitting a Track.....	20
Adjusting the Screen Brightness.....	5	Reviewing Tracks.....	20
Vehicle Profiles.....	6	Editing Tracks.....	20
Adding a Vehicle Profile.....	6	Navigating a Track.....	20
Choosing a Vehicle Profile.....	6	Viewing Your Garmin Explore™ or Race File Collections on the Map.....	20
Editing a Vehicle Profile.....	6	Viewing the Altimeter, Barometer, and Compass.....	20
Installation.....	7	Calibrating the Compass.....	21
Installing the Tread XL - Baja Race Edition Device.....	7	Group Ride.....	21
Mounting Considerations.....	7	Starting a Group Ride.....	21
Power Cable Overview.....	7	Joining a Group Ride.....	21
External Antenna Mounting Considerations.....	8	Rejoining a Recent Group Ride.....	21
Installing the External GNSS Antenna.....	8	Adding Riders to a Group Ride.....	22
Installing the External Iridium Antenna.....	9	Broadcasting a Message.....	22
Installing the Dock on a Vehicle Surface.....	9	Broadcasting a Location.....	22
Bail Mounting the Dock.....	10	Viewing a Group Ride Notification... ..	22
Connecting the Device to the Dock..	12	Exiting a Group Ride.....	22
Removing the Device from the Dock.....	13	Group Ride Settings.....	23
Installing the Tread XL - Baja Chase Edition Device.....	14	Radio.....	23
Mounting and Powering the Device in Your Vehicle.....	14	Selecting a Preset.....	23
		Selecting a Radio Channel.....	23
		Adjusting the Squelch.....	23
		Adding a Custom Radio Preset.....	23
		Selecting a Roger Tone.....	24
		Turning the Radio Off.....	24
		Enabling Push-to-Talk with a Headset.....	24
		Transmitting Your Voice.....	24
		Adjusting the Radio Volume.....	24
		Radio Settings.....	24
Off-Road Racing Features.....	15	inReach Features.....	25
Importing GPX Files with a Memory Card.....	15	Activating the Device.....	25
Starting a Race.....	15	Team Tracking Using Built-in inReach Technology.....	25
Race Navigation.....	16		
Using the Chase Map.....	17		
Creating Waypoints.....	17		

- Starting and Stopping Team Tracking..... 25
- Sharing Your MapShare Web Page.. 26
- inReach Tracking Settings..... 26
- Messages..... 26
 - Sending a Preset inReach Message..... 26
 - Sending a Text Message..... 26
 - Replying to a Message..... 26
 - Checking for Messages..... 27
 - Navigating to a Message Location.. 27
 - Deleting a Message..... 27
- SOS..... 27
 - Initiating an SOS Rescue..... 28
 - Canceling an SOS Rescue..... 28
- Contacts..... 28
 - Adding a Contact..... 28
 - Editing a Contact..... 29
 - Deleting a Contact..... 29
- Viewing Plan and Usage Details..... 29

Using the Map..... 29

- Map Tools..... 29
 - Viewing a Map Tool..... 29
- Customizing the Map..... 30
 - Customizing the Map Layers..... 30
 - Viewing the Public Lands Map Key..... 30
 - Enabling Adventure Roads and Trails Map Layers..... 30
 - Changing the Map Data Field..... 30
 - Changing the Map Buttons..... 30
 - Changing the Map Perspective..... 30

Using the Apps..... 31

- Viewing the Owner's Manual on Your Device..... 31
- BirdsEye Imagery..... 31
 - Downloading BirdsEye Imagery..... 31
- Garmin PowerSwitch™ App..... 32
 - Activating a Power Switch..... 32
 - Turning Off All Switches..... 32
 - Customizing a Button..... 33
 - Assigning a Switch to a Control Input..... 33
 - Adding a Custom Layout..... 33

- Adding a Button to a Custom Layout..... 34
- Arranging Buttons In a Custom Layout..... 34
- Deleting a Custom Layout or Button..... 34
- Routines..... 34
 - Adding a Routine..... 35
 - Editing a Routine..... 35
 - Deleting a Routine..... 35
- Tread Audio App..... 36
 - LED Controls..... 36
 - Enabling LED Groups..... 37
 - Changing the Media Source..... 37
 - LED Light Settings..... 37
 - Audio Zone Settings..... 37

Pairing with Your Smartphone..... 38

- Tips After Pairing the Devices..... 38
- Pairing Additional Bluetooth Devices.. 38
- Enabling or Disabling Bluetooth Features..... 38
 - Enabling or Disabling Bluetooth Features for Your Headset..... 38
- Disconnecting a Bluetooth Device..... 39
- Deleting a Paired Phone..... 39

Street Navigation..... 39

- Starting a Route..... 39
 - Starting a Route by Using the Map... 39
- Your Route on the Map..... 40
 - Viewing Turns and Directions..... 41
 - Viewing the Entire Route on the Map..... 41
- Changing Your Active Route..... 41
 - Adding a Location to Your Route..... 41
 - Shaping Your Route..... 41
- Avoiding Delays, Tolls, and Areas..... 41
 - Avoiding Toll Roads..... 41
 - Avoiding Road Features..... 42
 - Custom Avoidances..... 42
 - Avoiding a Road..... 42
 - Avoiding an Area..... 42
 - Disabling a Custom Avoidance..... 42
 - Deleting Custom Avoidances..... 42
- Arriving at Your Destination..... 42

- Changing the Route Calculation Mode..... 43
- Taking a Route Using Garmin Adventurous Routing™..... 43
- Taking a Detour..... 43
- Going Home..... 43
 - Editing Your Home Location..... 43
- Parking Near Your Destination..... 43

Finding and Saving Locations..... 44

- Finding a Location Using the Search Bar..... 44
- Location Search Results..... 45
- Changing the Search Area..... 45
- Finding a Location by Category..... 45
 - Navigating to Points of Interest Within a Venue..... 46
- Points of Interest..... 46
 - Finding National Parks..... 46
 - Finding Campgrounds..... 46
 - Finding Ultimate Campgrounds Points of Interest..... 47
 - Finding iOverlander™ Points of Interest..... 47
 - Finding Adventure Points..... 47
 - Tripadvisor..... 47
 - Finding Tripadvisor Points of Interest..... 47
- Finding Parking Near Your Current Location..... 48
- Search Tools..... 48
 - Finding an Address..... 48
 - Finding a Location Using Coordinates..... 48
- Viewing Recently Found Locations..... 48
 - Clearing the List of Recently Found Locations..... 48
- Viewing Current Location Information..... 48
 - Finding Emergency Services and Fuel..... 49
 - Getting Directions to Your Current Location..... 49
- Adding a Shortcut..... 49
 - Removing a Shortcut..... 49
- Saving Locations..... 49
 - Saving a Location..... 49
 - Saving a Waypoint on the Map..... 50

- Saving Your Current Location..... 50
- Editing a Saved Location..... 50
- Assigning Categories to a Saved Location..... 50
- Deleting a Saved Location..... 50

Settings..... 51

- Navigation Settings..... 51
- Map Display Settings..... 51
 - Enabling Maps..... 51
- Connecting to a Wireless Network..... 51
- Enabling Bluetooth Wireless Technology..... 51
- Display Settings..... 52
- Adjusting Sound and Notification Volume..... 52
- Setting the Text Language..... 52
- Date and Time Settings..... 52
- Device Settings..... 52
 - Enabling or Disabling Location Services..... 52

Device Information..... 52

- Viewing E-label Regulatory and Compliance Information..... 52
- Specifications..... 53
- Charging the Device..... 53

Device Maintenance..... 53

- Garmin Support Center..... 53
- Map and Software Updates..... 53
 - Updating Maps and Software Using a Wi-Fi Network..... 54
 - Product Updates..... 54
 - Updating Maps and Software with Garmin Express..... 55
- Device Care..... 56
 - Cleaning the Outer Casing..... 56
 - Cleaning the Touchscreen..... 56
 - Avoiding Theft..... 56
- Restarting the Device..... 56

Troubleshooting..... 56

- My device is not acquiring satellite signals..... 56
- My battery does not stay charged for very long..... 56

My device does not connect to my phone.....	57	Mounting the Speakers and Brackets.....	71
My device does not appear as a removable drive on my computer.....	57	Wiring.....	72
Appendix.....	57	Wire Gauge Guide.....	72
Garmin PowerSwitch.....	57	Additional Speakers.....	72
Mounting Considerations.....	57	Wireless Remote Overview.....	73
Mounting the Device.....	58	Connecting the Wireless Remote to your Tread Audio Box.....	73
Opening the Front Cover.....	59	Pairing with a Garmin Navigation Device.....	74
Connecting Accessories.....	60	Tread Audio Box Specifications.....	74
Connecting a Control Input.....	61	Tread 6.5" XS-LED Tower Speakers Specifications.....	75
Connecting the Device to Vehicle Power.....	61	Dimensions.....	75
Pairing with a Garmin Navigation Device.....	62	Bracket Specifications.....	76
Garmin PowerSwitch Specifications.....	62	Bracket Side Dimensions.....	76
Garmin PowerSwitch Troubleshooting.....	62	Bracket Top Dimensions.....	76
My Garmin PowerSwitch will not stay connected.....	62	Data Management.....	76
My accessories are not receiving power.....	63	About Memory Cards.....	77
Tread Audio.....	63	Installing a Memory Card for Maps and Data.....	77
Tools and Materials Needed.....	63	Formatting the Memory Card.....	77
Tread Audio Box Mounting Considerations.....	63	Connecting the Device to Your Computer.....	77
Mounting the Tread Audio Box Black Box Device.....	64	Transferring GPX Files From Your Computer.....	77
Connections.....	64	Transferring Data From Your Computer.....	78
Port Identification.....	64	Disconnecting the USB Cable.....	78
Speaker and LED Wiring Harness Wire and Connector Identification.....	65	Adding BaseCamp™ Data to Garmin Explore.....	78
RCA Wiring Harness Wire and Connector Identification.....	66	Exporting Data from BaseCamp with a PC.....	78
Connecting the Device to Vehicle Power.....	67	Exporting Data from BaseCamp with an Apple Computer.....	78
Using the Heat-Shrink Crimp Connectors.....	68	Importing Data to Garmin Explore.....	79
Complete System Wiring.....	68	Purchasing Additional Maps.....	79
Speaker Zones.....	69		
Single-Zone System Wiring Example.....	69		
Wireless Remote Mounting Considerations.....	70		
Mounting the Wireless Remote....	70		

Getting Started

⚠ WARNING

See the *Important Safety and Product Information* guide in the product box for product warnings and other important information.

Setting Up Your Device

To take full advantage of the Tread XL device, complete these tasks.

- 1 Install the device and connect it to vehicle power (*Installation*, page 7).
- 2 Update the device software (*Updating Maps and Software Using a Wi-Fi Network*, page 54).
- 3 Set up inReach® team tracking features (*Activating the Device*, page 25).
- 4 Import .gpx files to your device (*Importing GPX Files with a Memory Card*, page 15).

Device Overview

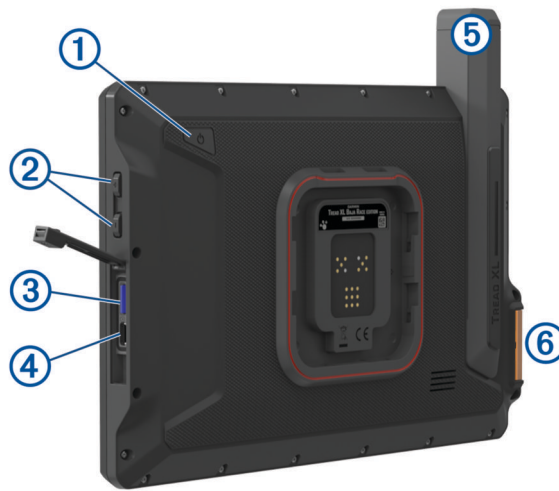















①	Power button
②	Volume control
③	microSD® memory card slot
④	USB power and data port
⑤	Iridium® antenna
⑥	SOS button (under protective cover)

Tread XL Dock Overview

The Tread XL Dock accessory securely holds your device while you travel over rough terrain. Before you can use the dock features, you must install the dock and connect it to vehicle power.



	Latch	Press down to secure the navigation device in the dock.
	Lock switch	Slide the switch toward the latch to lock the navigation device in the dock.
	Power port	Connect to vehicle power using the included power cable.
	Data port	Connect to an optional Group Ride accessory.
	Iridium antenna port	Connect to an external Iridium antenna.
	GNSS antenna port	Connect to an external GNSS antenna.
		Press to turn on the navigation device.
		Press to zoom out the map.
		Press to zoom in the map.
		Press to move through menu items or scroll the map.
		Press to return to the previous screen.
		Press to select an option.
		Press to open the map.
		Press to open the Team Tracking map tool.
		Press to save a waypoint.

Turning the Device On or Off

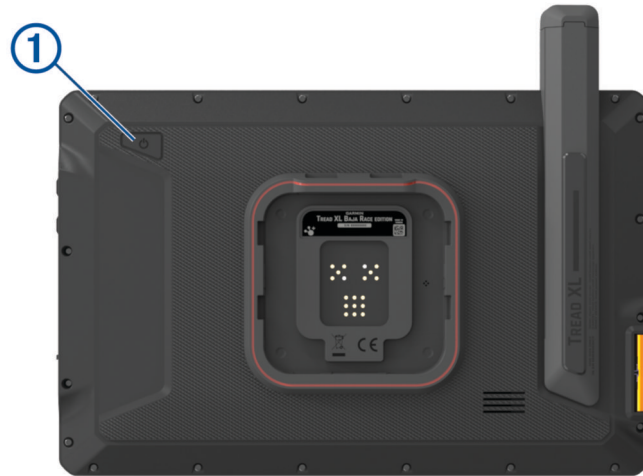

- To turn the device on, press the power button ①, or connect the device to power.



- To put the device in power saving mode, press the power button while the device is on. While in power saving mode, the screen is off and the device uses very little power, but it can wake instantly for use.
TIP: You can charge your device faster by putting it in power saving mode while charging the battery.
- To turn off the device completely, hold the power button until a prompt appears on the screen, and select **Power off**.





Acquiring GPS Signals

When you turn on your navigation device, the GPS receiver must collect satellite data and establish the current location. The time required to acquire satellite signals varies based on several factors, including how far you are from the location where you last used your navigation device, whether you have a clear view of the sky, and how long it has been since you last used your navigation device. The first time you turn on your navigation device, it may take several minutes to acquire satellite signals.

- 1 Turn on the device.
- 2 Verify  appears in the status bar, and enable location services if it does not ([Enabling or Disabling Location Services, page 52](#)).
- 3 If necessary, go to an open area with a clear view of the sky, away from tall buildings and trees.
 appears at the top of the navigation map until the device determines your location.

Status Bar Icons

The status bar is located at the top of the main menu. The status bar icons display information about features on the device. You can select some icons to change settings or view additional information.







	Location services status. Indicates your location has been established.
	Wi-Fi® signal strength.
	Active vehicle profile.
9:10	Current time.
	Battery charge level.
	Tread app connection status (<i>Pairing with Your Smartphone, page 38</i>).

Using the Touchscreen

- Tap the screen to select an item.
- Drag or swipe your finger across the screen to pan or scroll.
- Pinch two fingers together to zoom out.
- Spread two fingers apart to zoom in.



Using the On-Screen Buttons

On-screen buttons allow you to navigate the pages, menus, and menu options on your device.

- Select  to return to the previous menu screen.
- Hold  to quickly return to the main menu.
- Select  or  to scroll through lists or menus.
- Hold  or  to scroll faster.
- Select  to see a context-based menu of options for the current screen.

Adjusting the Screen Brightness

You can adjust the brightness manually, using either the notification panel or the settings menu.









- 1 Select an option:
 - Swipe down twice from the top of the screen to expand the quick settings in the notification panel.
 - Select  > **Tools** >  > **Device** > **Display** > **Brightness level**.
- 2 Use the slider to adjust the brightness.

Vehicle Profiles

WARNING



Entering your vehicle profile characteristics does not guarantee that your vehicle's characteristics will be accounted for in all route suggestions. Limitations may exist in map data for some route suggestions. Always defer to all posted road signs and conditions during vehicle operation. Failure to do so could lead to an accident involving personal injury or death.

Vehicle profiles allow you to choose different settings based on each vehicle you use with the device. The current vehicle profile is indicated by an icon in the status bar. If your vehicle profile includes a trailer, an icon of the trailer appears with the vehicle icon.

	Race profile
	ATV profile
	Side-by-Side profile
	Full Size profile
	Other profile
	Profile with a trailer
	Profile with a travel trailer
	Profile with a boat trailer

Adding a Vehicle Profile

You can add a vehicle profile for each vehicle to be used with your device.







- 1 Select  > **Tools** >  > **Vehicle Profile** > .
- 2 Select your current vehicle.
- 3 Follow the on-screen instructions to enter the vehicle characteristics.

Choosing a Vehicle Profile

- 1 Swipe down twice from the top of the screen.
- 2 Select the vehicle profile icon on the status bar.

Editing a Vehicle Profile

You can change basic vehicle profile information or add detailed information to a vehicle profile, such as maximum speed.

- 1 Select  > **Tools** >  > **Vehicle Profile**.
- 2 Select the vehicle profile to edit.
- 3 Select an option:
 - To edit the vehicle profile information, select , and select a field to edit.
 - To rename the vehicle profile, select  >  > **Rename Profile**.
 - To delete the vehicle profile, select  >  > **Delete**.

Installation

⚠ WARNING

See the *Important Safety and Product Information* guide in the product box for product warnings and other important information.

Garmin® strongly recommends having an experienced installer with the proper knowledge of electrical systems install the device. Incorrectly wiring the power cable can result in damage to the vehicle or the battery and can cause bodily injury.

⚠ CAUTION

To avoid possible personal injury, always wear safety goggles, ear protection, and a dust mask when drilling, cutting, or sanding.

NOTICE

Avoid wires, gauges, air bags, air bag covers, HVAC, and other items when drilling pilot holes and attaching the mount to the vehicle. Garmin is not responsible for any damages or consequences arising from the installation.

Installing the Tread XL - Baja Race Edition Device

Mounting Considerations

You can flush mount the device in the dashboard, or bail mount the device on the dashboard.

When selecting a mounting location, observe these considerations.

- You must select a location that is strong enough to support the weight of the dock and the device.
- You must select a location that allows room for the routing and connection of all of the cables.
- You should mount the device to provide an optimal viewing angle as you operate your vehicle.

Power Cable Overview

⚠ WARNING

See the *Important Safety and Product Information* guide in the product box for product warnings and other important information.

Garmin strongly recommends having an experienced installer with the proper knowledge of electrical systems install the device. Incorrectly wiring the power cable can result in damage to the vehicle or the battery and can cause bodily injury.

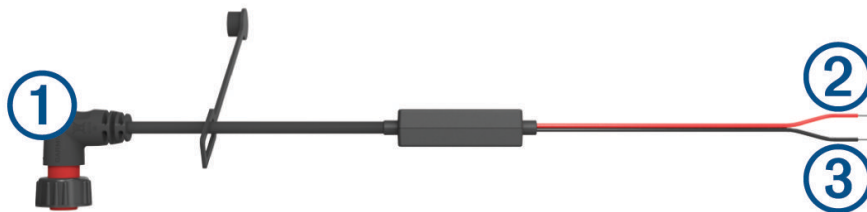

①	Mount connector
②	12 to 24 Vdc system power (red)
③	System ground (black)

External Antenna Mounting Considerations

You can install the external antennas on your vehicle to get the most accurate position data for your navigation device. For best performance, consider these guidelines when selecting the antenna mounting location.

NOTE: External antennas are included only with the Tread XL - Baja Race Edition device.

- To ensure the best reception, you should mount the antennas in a location that has a clear, unobstructed view of the sky in all directions.
- You should not mount the antennas near the engine or other sources of electromagnetic interference (EMI).
- You must mount the antennas at least 5 cm (2 in.) apart from each other.

Installing the External GNSS Antenna

⚠ CAUTION

To avoid possible personal injury, always wear safety goggles, ear protection, and a dust mask when drilling, cutting, or sanding.

NOTICE

When drilling or cutting, always check what is on the opposite side of the surface to avoid damaging the vehicle.

This antenna can be installed to provide a more accurate position from the GPS signal for your navigation device. This antenna uses a BNC connector to connect to the dock.

- 1 Using the included mounting template, mark the three pilot-hole locations ① and trace the cable hole in the center of the template.

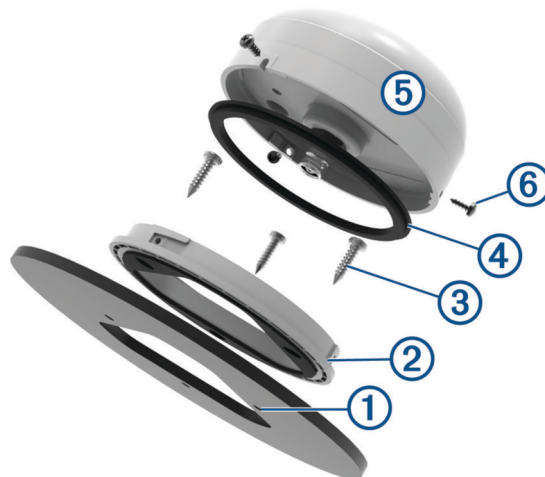

- 2 Drill the three 3.2 mm ($1/8$ in.) pilot holes.
- 3 Use a 25 mm (1 in.) hole saw to cut the cable hole in the center.
- 4 Place the surface-mount bracket ② on the mounting surface, aligning the screw holes.
- 5 Use the included M4 screws ③ to secure the surface-mount bracket to the mounting surface.
- 6 Place the large gasket ④ on top of the surface-mount bracket.
- 7 Route the antenna cable through the 25 mm (1 in.) hole, and connect it to the antenna ⑤.
- 8 Place the antenna on the surface-mount bracket, and twist it clockwise to lock it in place.
- 9 Secure the antenna to the mounting bracket with the included M3 set screws ⑥.
- 10 Route the cable into the vehicle and away from sources of electronic interference.
- 11 Connect the cable to GNSS on the dock.

Installing the External Iridium Antenna

You can use the included bracket to mount the Iridium antenna to an external surface on your vehicle.

- 1 Using the antenna mounting bracket ① as a template, mark the pilot hole locations ②.

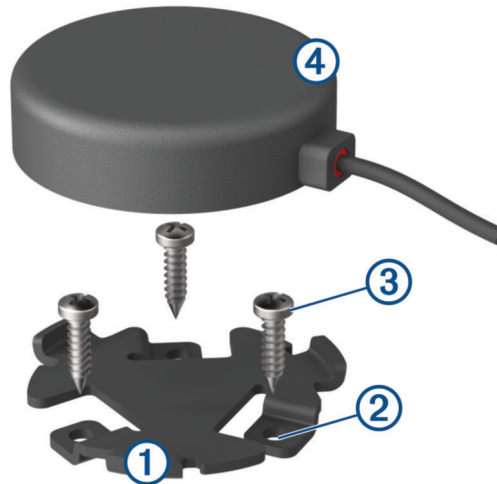

- 2 Drill the three 3.2 mm ($1/8$ in.) pilot holes (optional).
For some types of mounting material, drilling pilot holes is necessary. Do not drill through the mount.
- 3 Using the included screws ③, secure the mounting bracket to the mounting location.
- 4 Place the magnetic Iridium antenna ④ in the mounting bracket.
- 5 Route the antenna cable into the vehicle and connect it to IRIDIUM on the dock.

Installing the Dock on a Vehicle Surface

Before you can mount the dock, you must select a mounting location and purchase the appropriate hardware for your mounting surface.

NOTICE

Avoid wires, gauges, air bags, air bag covers, HVAC, and other items when drilling pilot holes and attaching the mount to the vehicle. Garmin is not responsible for any damages or consequences arising from the installation.

- 1 Trim the included mounting template and place it in the location where you want to mount the device.
- 2 Using a jigsaw or rotary tool, cut the mounting surface along the inside of the dashed line indicated on the template.
- 3 Place the dock into the cutout to test the fit.
- 4 Remove the dock from the cutout.
- 5 If necessary, use a file and sandpaper to refine the size of the cutout.
- 6 Drill the pilot holes in the locations marked on the mounting template.
- 7 Remove the template from the mounting surface.
- 8 If you will not have access to the back of the dock after you mount it, connect all of the necessary cables to the dock before placing it into the cutout.

- 9 Place the dock into the cutout.



- 10 Secure the dock to the mounting surface using the appropriate hardware.

Bail Mounting the Dock

Before you can install the bail-mount bracket, you must select a mounting location and purchase or fabricate the appropriate hardware for your mounting surface.

You can use the included brackets to bail mount the device on a flat surface.

- 1 Using the base of the bail-mount bracket ① as a template, mark the pilot holes.



- 2 Using the appropriate size drill bit for your mounting hardware, drill the pilot holes. Do not drill through the mount.
- 3 Secure the bail-mount bracket to the mounting surface using the appropriate hardware.
- 4 Screw the bail-mount knobs ② into the sides of the bail-mount adapter ③.
- 5 Place the bail-mount adapter into the bail-mount bracket, and tighten the bail-mount knobs.

- 6 Connect all of the necessary cables to the back of the dock.
- 7 Secure the dock to the bail-mount adapter using the included screws ④.

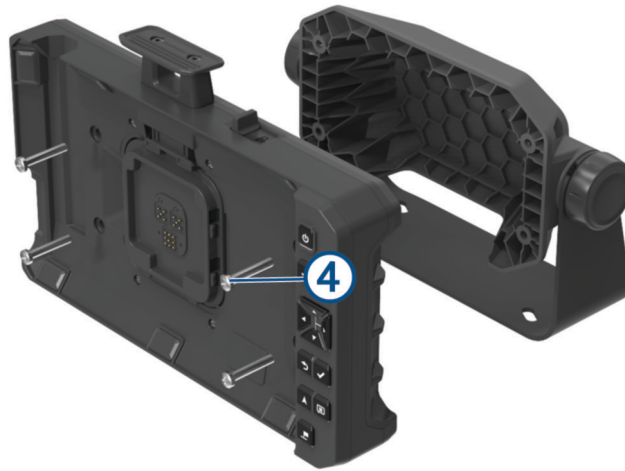

Connecting the Device to the Dock

- 1 Remove the protective cover from the dock.

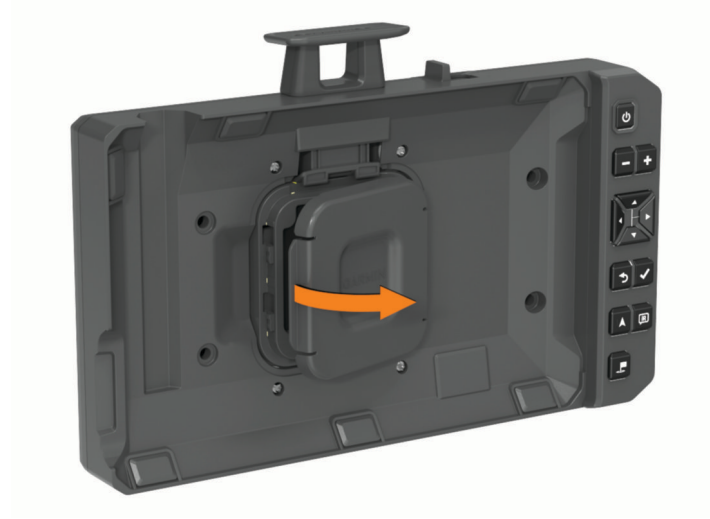

TIP: You should keep the protective cover for future use. Always use the protective cover while the device is removed from the dock.

- 2 Place the navigation device into the magnetic mount.



- 3 Press down the lock latch ① completely, and slide the lock switch ② toward the latch.

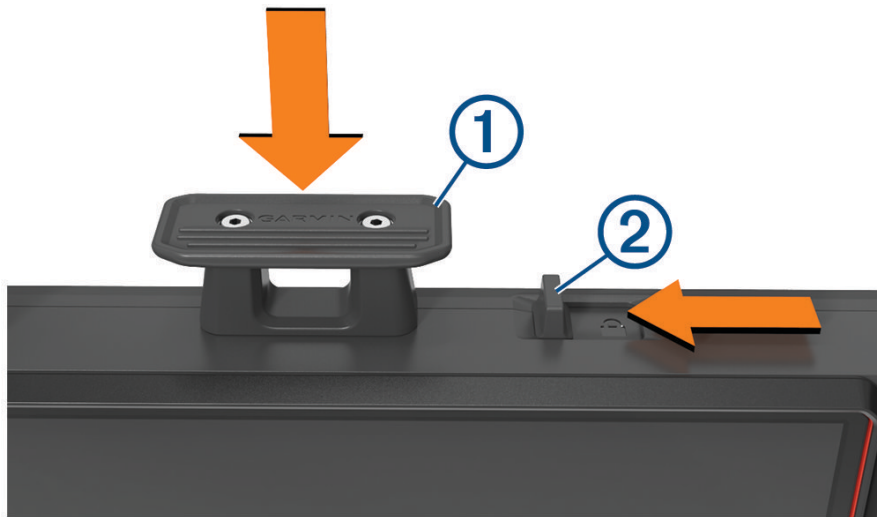

Removing the Device from the Dock

- 1 Slide the lock switch away from the latch.

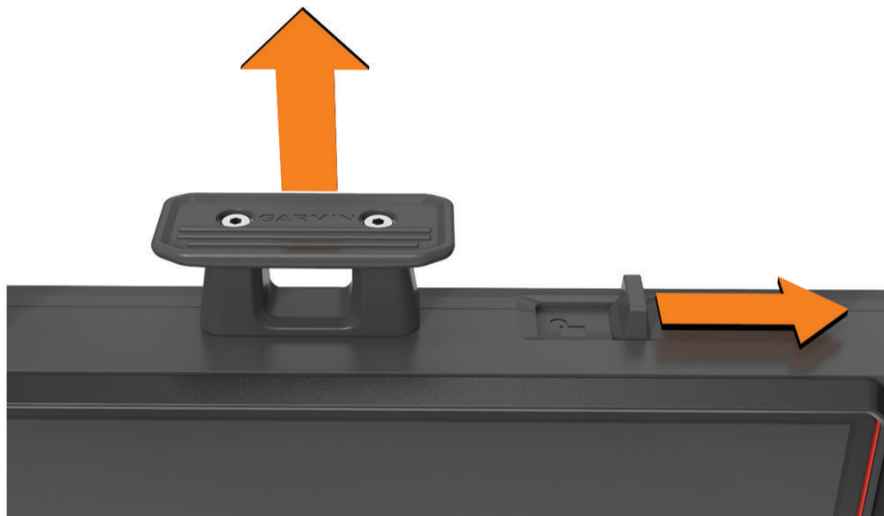

- 2 Pull up the latch.
- 3 Pull the navigation device out of the dock.

Installing the Tread XL - Baja Chase Edition Device

Mounting and Powering the Device in Your Vehicle

⚠ WARNING

This product contains a lithium-ion battery. To prevent the possibility of personal injury or product damage caused by battery exposure to extreme heat, store the device out of direct sunlight.

Both the device and its mount contain magnets. Under certain circumstances, magnets may cause interference with some internal medical devices and electronic devices, including pacemakers, insulin pumps, or hard drives in laptop computers. Keep the device away from medical devices and electronic devices.

Before you use your device on battery power, you should charge it.

- 1 Open the lever ①, press the suction cup to the windshield, and flip the lever back toward the windshield. The lever must be oriented toward the top of the windshield.

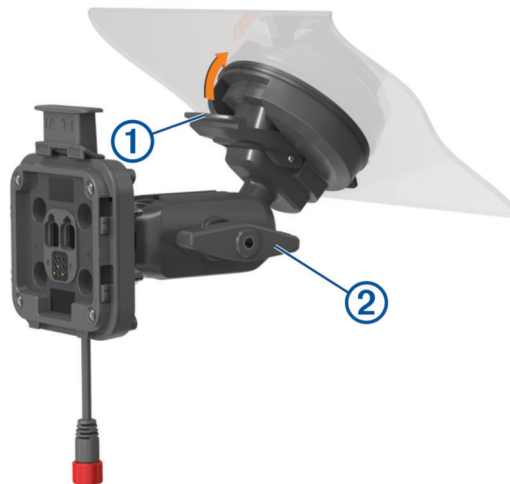

- 2 Tighten the knob ② slightly.
- 3 If necessary, adjust the mount for better viewing and operation.
- 4 Tighten the knob to secure the mount.
- 5 Connect the vehicle power cable ③ to the cable ④ on the mount.

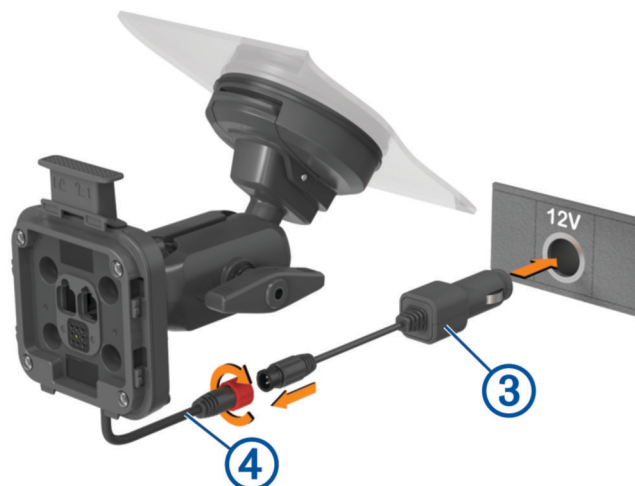

- 6 Tighten the collar around the connected power cables.
- 7 Plug the other end of the vehicle power cable into a power outlet in your vehicle.

- 8 Place the device onto the magnetic mount.



- 9 Push down the lock ⑤ to secure the device to the mount.

Off-Road Racing Features

Importing GPX Files with a Memory Card

You can import data, such as waypoints and tracks in GPX file format from a compatible microSD card.

- 1 Insert a compatible microSD card containing one or more .gpx files into the memory card slot on your device ([Installing a Memory Card for Maps and Data, page 77](#)).
- 2 On your Tread XL device, select **Race Files** > **⋮** > **Import**.
- 3 Select one or more .gpx files, and select **OK**.
- 4 Select an option:
 - To import all waypoints and tracks, select **Select All**.
 - To import specific locations, select **Waypoints** or **Tracks**, and select one or more locations.
- 5 Select an option:
 - To import the data to a new collection, select **New Collection**, and enter a name for the collection.
 - To import the data to an existing collection, select a collection.
- 6 Select **Import**.

Starting a Race

Before you can start a race, you must import .gpx files to your device ([Importing GPX Files with a Memory Card, page 15](#)).

- 1 From the main menu, select **Race**.
NOTE: If you have previously configured a race, the device shows the most recent race.
- 2 Select one or more tracks, and select **Next**.
- 3 If necessary, adjust the order of the tracks, and select **Next**.
If you select more than one track, the device displays a preview of the combined tracks.
- 4 Select **Go!**.

Race Navigation

As you travel, the device displays your map location and the waypoints ahead of you on your route.

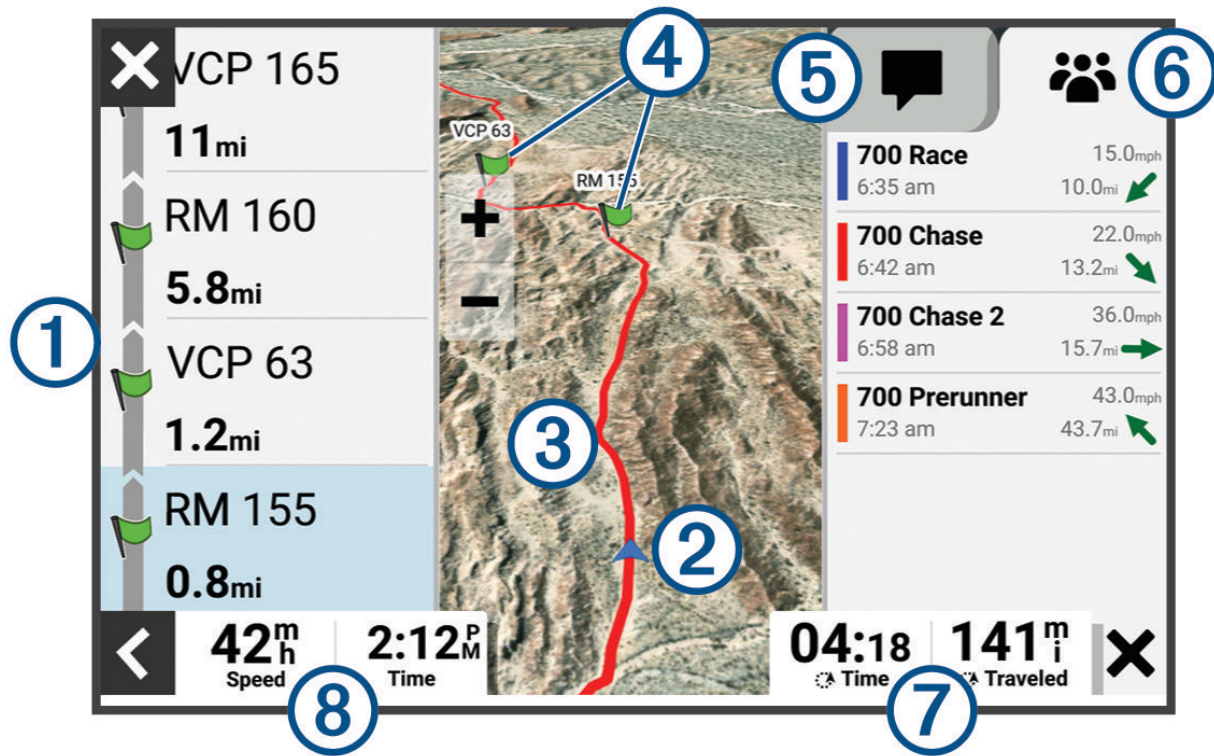

①	Upcoming waypoints along your route.
②	Vehicle location.
③	Route highlighted on the map.
④	Upcoming waypoints on the map.
⑤	inReach messages.
⑥	Tracked team member locations.
⑦	Data fields. TIP: You can tap these fields to change the information they show.
⑧	Vehicle speed.

Using the Chase Map

You can use the Chase Map feature to keep track of your team members.

- 1 From the main menu, select **Chase Map**.

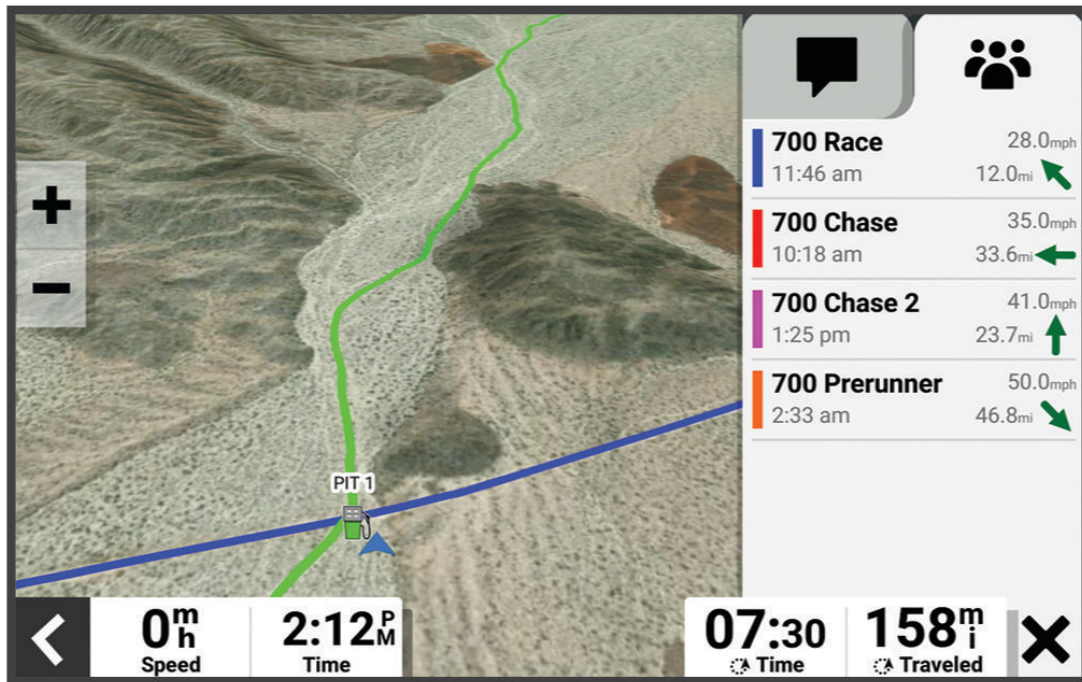

- 2 Select an option:

- To view a team member's location, select the team member.
- To navigate to a point on the map, tap a map location, and select **Go!**.

Creating Waypoints

Your co-driver can mark waypoints as you drive. You can customize each waypoint with pace notes and symbols.

- 1 While navigating a track, press .
- 2 If necessary, select the notification to enter information about the waypoint.

Locking and Unlocking the Touchscreen

You can lock the screen to prevent inadvertent screen touches.

- 1 Hold , and select **Lock Screen** to lock the touchscreen.
- 2 Hold , and select **Unlock Screen** to unlock the touchscreen.

Off-Road Navigation Features

Routes

A route is a path from your current location to one or more destinations.

- For off-road use, you can set the device to calculate point-to-point routes in a straight line ([Straight Line Routes](#), page 19).
- The device calculates a recommended route to your destination based on the preferences you set, including the route calculation mode ([Changing the Route Calculation Mode](#), page 43) and avoidances ([Avoiding Delays, Tolls, and Areas](#), page 41).
- The device can automatically avoid roads that are not appropriate for the active vehicle profile.
- You can start navigating to your destination quickly using the recommended route, or you can select an alternate route ([Starting a Route](#), page 39).
- If there are specific roads you need to use or avoid, you can customize the route ([Shaping Your Route](#), page 41).
- You can add multiple destinations to a route ([Adding a Location to Your Route](#), page 41).

Adventure Roads and Trails

⚠ WARNING

Entering your vehicle profile characteristics does not guarantee that your vehicle's characteristics will be accounted for in all route suggestions. Limitations may exist in map data for some route suggestions. Always defer to all posted road signs and conditions during vehicle operation. Failure to do so could lead to an accident involving personal injury or death.

This device can navigate off-highway roads and trails based on your vehicle profile. Trails ① are color coded based on accessibility. You can select  to set which adventure roads and trails appear on the map.

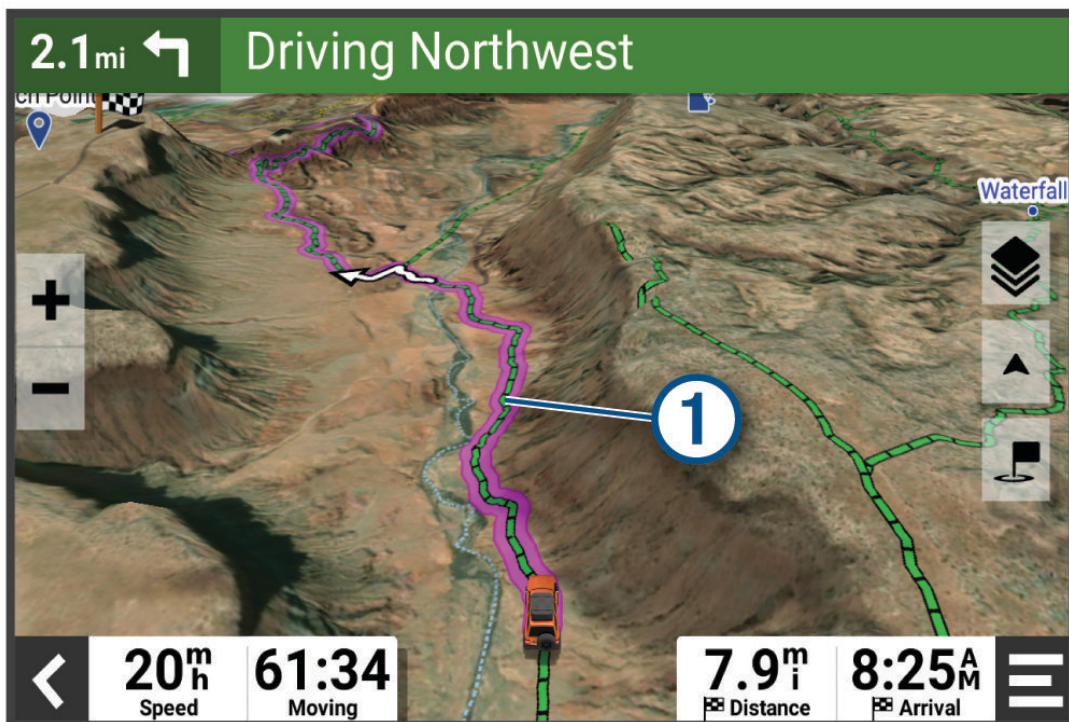

Straight Line Routes

For areas without defined roads or trails, the device guides you to your destination using a straight line route. You can set multiple waypoints to navigate a route through areas without roads.



- ① Distance to the destination.
- ② Route highlighted on the map.
- ③ Vehicle speed.
- ④ Map tools. Provides tools to show you more information about your route and surroundings.
- ⑤ Map layers. Allows you to change the map orientation and add topographic and BirdsEye imagery to your map view.

Stopping the Route

From the map, select **< > Stop**.

Tracks

A track is a recording of your path. The track log contains information about the recorded path, including time, location, and elevation information.

Recording Tracks

Tracking records your path. When you start tracking, your device logs your location and updates the track line.

Select **Track Recorder > Start**.

Splitting a Track

You can split tracks to divide longer tracks into segments. You can use this information to compare the time, speed, and distance traveled for each split.

While recording a track, select **Split**.

Reviewing Tracks

You can review tracks that you have previously recorded.

1 From the main menu, select  > **Apps** > **Tracks**.

2 Select a track, and select .

The track appears on the map with the recorded statistics about the track.

3 If necessary, select  to change the track shading.

Editing Tracks

You can edit tracks that you have previously recorded.

1 From the main menu, select  > **Apps** > **Tracks**.

2 Select a track, and select .

The track appears on the map.

3 Select an option:

- To add points to a track or extend the track, select **Add**, and follow the on-screen instructions.
- To delete a point from the track, select **Delete**, and select a point on the track.
- To move a point on the track, select **Move**, and follow the on-screen instructions.
- To reverse the track, select **Reverse**.
- To join the current track with another track, select **Join**, and select a track.

TIP: You can select  to undo the last action.

Navigating a Track

You can navigate a saved track using the Race Files app on your device.

1 Select  > **Race** > **Race Files**.

2 Select a track.

3 Select **Go!**.

Viewing Your Garmin Explore™ or Race File Collections on the Map

You can view your Garmin Explore and race file collections directly on the map. You must enable the collections map layer to use this feature.

NOTE: If you do not assign a collection category to your Garmin Explore data, it appears as an unorganized collection.

1 Select  > **Tools** >  > **Map Display** > **Map Layers** > **Collections**.

2 Select one or more collection categories from the list.

3 Select **Save**.

Your collections appear as icons on the map.

Viewing the Altimeter, Barometer, and Compass

The device contains internal altimeter, barometer, and compass sensors with automatic calibration.

Select  > **Apps** > **ABC**.

TIP: You can also select the Altimeter or Barometer widget to open the ABC app.

Calibrating the Compass



NOTICE

Calibrate the electronic compass outdoors. To improve heading accuracy, do not stand near metal objects or objects that influence magnetic fields, such as vehicles, electronic devices, buildings, or overhead power lines.

When your device is connected to the mount, it uses GPS data to determine your compass heading. When you remove the device from the mount, it uses a built-in compass to show your heading.

Each time you disconnect your device from the mount, you may need to calibrate the compass.

If you experience irregular compass behavior, for example, after moving long distances or after extreme temperature changes, you can manually calibrate the compass to improve accuracy.

- 1 Disconnect the device from the mount and move away from objects that influence magnetic fields.
- 2 From the main menu, select  > **Apps** > **ABC** >  > **Calibrate Compass**.
- 3 Follow the on-screen instructions.

Group Ride

The Group Ride app allows you to coordinate rides and communicate with nearby riders using preset text messages, live map locations, and voice communications. You can pair your Tread XL device with the Tread app on your smartphone to enable Group Ride tracking features.

Voice communication and preset messaging require a Group Ride accessory, which is not included with all product models. The voice communication feature is not available in all areas. Go to garmin.com/tread for more information, or to purchase a Group Ride accessory.

Starting a Group Ride

You can create a group ride that allows you to choose the group radio channel, view and remove riders who join your group ride, and set the group ride name. You can create a group ride using a connected Group Ride mount, the Tread app, or both.

- 1 From the main menu, select  > **Apps** > **Group Ride** > **Start a Group Ride**.
- 2 Select an option:
 - To start a group ride with riders that have a Group Ride mount, select **Create a Radio Group Ride**.
 - To start a group ride with riders using the Tread app, select **Create a Mobile Group Ride**.
- 3 If necessary, select the radio channel, and select **Next**.
- 4 Enter your rider name, and select **Done**.
- 5 Enter the ride name, and select **Done**.
As riders join your group ride, their names appear on the list.
- 6 Select **Start**.
The group ride begins after all of the riders sync with the group ride.

Joining a Group Ride

You can join a nearby group ride that was created by another rider.

- 1 From the main menu, select  > **Apps** > **Group Ride** > **Join a Group Ride**.
- 2 Select a nearby group ride, and select **Join**.



Rejoining a Recent Group Ride

You can rejoin any of your ten most-recent group rides.

- 1 From the main menu, select  > **Apps** > **Group Ride** > **Recent Group Rides**.
- 2 Select a recent group ride, and select **Join**.

Adding Riders to a Group Ride

You can add riders to a group ride that is already in progress.



- 1 From the main menu, select  > **Apps** > **Group Ride**.
- 2 If necessary, select .
- 3 Select **Add**.
As new riders join the group ride, they appear on the list.
- 4 Select **Continue**.

Broadcasting a Message

WARNING

Do not read, send, or reply to any messages while driving, because doing so can cause a distraction that could lead to an accident resulting in serious personal injury or death.

You can broadcast a preset message to the members in your active group ride that are in range of the VHF radio.



- 1 From the main menu, select  > **Apps** > **Group Ride**.
- 2 If necessary, select .
- 3 Select **Broadcast to Group**.
- 4 Select a preset message, and select **Send**.

Broadcasting a Location

WARNING

While driving, do not interact with the display to broadcast your location, because doing so can cause a distraction that could lead to an accident resulting in serious personal injury or death.

You can broadcast a location to the members in your active group ride that are in range of the VHF radio.

- 1 From the main menu, select  > **Apps** > **Group Ride**.
- 2 If necessary, select .
- 3 Select **Broadcast to Group** > **Broadcast a Location**, and select a location.
- 4 Select **Share**.



Viewing a Group Ride Notification

WARNING

Do not read or reply to any notifications while driving, because doing so can cause a distraction that could lead to an accident resulting in serious personal injury or death.

For most pages, a notification appears when the device receives a broadcasted group ride location or message. You can also view group ride notifications in the Group Ride app.

NOTE: When you are viewing the map, new notifications appear in a map tool at the edge of the screen.

- 1 From the main menu, select  > **Apps** > **Group Ride** > , and select a notification.
- 2 Select **Go!** to navigate to a shared location.

Exiting a Group Ride

- 1 From the main menu, select  > **Apps** > **Group Ride**.
- 2 If necessary, select .
- 3 Select **Exit** > **Yes**.

Group Ride Settings

From the main menu, select  > **Apps** > **Group Ride** > .

Edit Rider Name: Allows you to set your name that displays during a group ride. This setting is not available during an active group ride.

Rider Map Labels: Sets the label displayed for each active rider on the map.

Show Tracks on Map: Shows the track that each group ride member takes on the map.

Reset Default Settings: Allows you to reset all group ride settings to default values. This setting is not available during an active group ride.

Radio



NOTE: This feature is not available on all product models.

NOTE: Before you can use the Radio app, you must install a Group Ride accessory. Go to garmin.com to purchase a Group Ride accessory.



You can use the Radio app to create radio presets, select a radio channel, and select squelch codes. To use this feature, you must connect the device and the antenna to the Group Ride mount. The Tread XL device configures radio settings automatically when you join or create a group ride.

Selecting a Preset

NOTE: For some product models, the Radio app is located in the apps menu.



- 1 From the main menu, select  > **Apps** > **Radio**.
- 2 Select an option:
 - To move through the available presets, select  or .
 - To select a preset from the menu, select **Preset**.

Selecting a Radio Channel





- 1 From the main menu, select  > **Apps** > **Radio**.
- 2 Select an option:
 - To move to a different channel, select  or .
 - To select a MURS channel from the menu, select **Channel**.

Adjusting the Squelch

You can adjust the squelch and change between CTCSS, DCS, and Open squelch modes to improve audio quality and avoid radio interference in your area.



- 1 From the main menu, select  > **Apps** > **Radio**.
- 2 Select an option:
 - To choose a squelch code within the current mode, select  or .
 - To adjust the squelch mode, select **Open**.

Adding a Custom Radio Preset

- 1 Select  > **Apps** > **Radio** > **Preset** > .
- 2 Select  or  to select a channel and squelch code.
- 3 Select **Save**.

Selecting a Roger Tone

You can select the tone other devices play when you operate your radio.



- 1 Select  > **Apps** > **Radio** >  > **Roger Tone**.
- 2 Select a roger tone.
The device plays the selected tone.
- 3 Select **Save**.

Turning the Radio Off

Select  > **Apps** > **Radio** >  > **Yes**.

Enabling Push-to-Talk with a Headset

You can enable push-to-talk controls for use with a compatible Bluetooth® headset. This allows you to transmit your voice using the voice dial feature on your headset.

- 1 Select  > **Apps** > **Radio** >  > **Push to Talk with Headset**.
- 2 If necessary, follow the on-screen instructions to pair your headset with the device.
- 3 Select **Push to Talk with Headset**.
- 4 Select .

Transmitting Your Voice

Before you can transmit your voice, you must pair your Tread XL device with a compatible Bluetooth headset or connect the fist microphone.

You can transmit your voice over the radio using the connected fist microphone or a compatible Bluetooth headset.

Select an option:

- Hold the push-to-talk button on the side of the connected fist microphone.
- From the main menu, select  > **Apps** > **Radio** > **Push to Talk**.
- Use the voice dial feature on your connected Bluetooth headset (*Enabling Push-to-Talk with a Headset, page 24*).

TIP: You can press the pause or stop button to manually close the radio.

NOTE: You must enable the **Push to Talk with Headset** setting to use this feature (*Radio Settings, page 24*).

Adjusting the Radio Volume

- 1 Select  > **Apps** > **Radio** > .
- 2 Use the slider bars to adjust the volume.

Radio Settings

From the main menu, select  > **Apps** > **Radio** > .

Push to Talk with Headset: Enables you to transmit your voice using the push-to-talk button on your compatible headset.

Roger Tone: Sets the roger tone the device plays when you operate your radio.

Reset Default Settings: Resets all radio settings and presets to factory default values.

inReach Features

⚠ WARNING

Before you can use the inReach features of your Tread XL device, including messaging, SOS, and team tracking, you must have an active satellite subscription. Always test your device outdoors before you use it.

Ensure you have a clear view of the sky when using the messaging, tracking, and SOS functions, because these features require satellite access to operate properly.

NOTICE

Some jurisdictions regulate or prohibit the use of satellite communications devices. It is the responsibility of the user to know and follow all applicable laws in the jurisdictions where the device is intended to be used.

Activating the Device

⚠ WARNING

Before you can use the inReach features of your Tread XL device, including messaging, SOS, and team tracking, you must activate the device.

- 1 From your computer or smartphone, go to garmin.com/teamtracking to create an account and activate a service plan.
- 2 Turn on the device.
- 3 From the main menu on your device, select **Team Tracking**.
- 4 Follow the on-screen instructions.
NOTE: You must enter the device IMEI number and authorization code to complete the online portion of the activation before you go outdoors.
- 5 Go outdoors to an open area with a clear view of the sky, and point the antenna on the device toward the sky for optimal performance.
- 6 Wait while the device communicates with the Iridium satellite network.
NOTE: It may take up to 20 minutes to activate your device. The device must send and receive several messages, which takes longer than sending a single message during regular use. Your device should remain outdoors until activation finishes.

Team Tracking Using Built-in inReach Technology



NOTICE

Team tracking requires an active inReach team subscription. Some jurisdictions regulate or prohibit the use of satellite communications devices. It is the responsibility of the user to know and follow all applicable laws in the jurisdictions where the device is intended to be used.

You can use the team tracking feature on your Tread XL device to record track points and transmit them over the Iridium satellite network. Your team members can view your location while inReach team tracking is enabled.

Starting and Stopping Team Tracking

Before you can start a team tracking session, you must activate a service plan ([Activating the Device, page 25](#)).

- To start team tracking, select **Team Tracking** > .
- To stop team tracking, select **Team Tracking** > .

Sharing Your MapShare Web Page

You can enable MapShare at inreach.garmin.com.

You can share a link to your MapShare webpage with other people. The system automatically adds text, including link information, to the end of your message.

- 1 Select **Team Tracking** >  > **Send MapShare**.
- 2 Select **To:**, and add one or more contacts.
- 3 Select **Message:**, and enter a message.
- 4 Select **Send**.

inReach Tracking Settings

Select **Team Tracking** > .

Tracking Sync: Sets the device to use the track recorder and inReach tracking simultaneously.

Auto Track: Sets the device to start tracking when you turn on the device.

Messages

WARNING

Do not read or send any messages while driving, because doing so can cause distraction that could lead to an accident resulting in serious personal injury or death.

Your Tread XL device sends and receives text messages using the Iridium satellite network. You can send messages to an SMS phone number, an email address, or another device that uses inReach technology. Each message you send includes your location details where allowed.

Sending a Preset inReach Message

Preset messages have predefined text and predetermined recipients. You must set up preset messages using the Garmin Explore website at inreach.garmin.com.

- 1 Select **Team Tracking** > **Presets**.
- 2 Select a preset message, and select **Send**.

Sending a Text Message

- 1 Select **Team Tracking** > **Compose**.
- 2 Select one or more contacts, and select **Done**.
- 3 Enter a message.
- 4 Select **Send**.

Replying to a Message

- 1 Select **Team Tracking**.
- 2 Select a conversation, and select **Reply**.
- 3 Select an option:
 - To start with a pre-written message, select a quick text message from the top of the screen.
NOTE: You can add and edit quick text messages on the Garmin Explore website.
 - To write a custom message, enter a message.
- 4 Select **Done**.

Checking for Messages

When you send a message, your device listens for replies for 10 minutes. The device also checks for new messages every hour. When you are using the inReach tracking feature, your device automatically checks for messages at your tracking interval.

NOTE: To receive messages, your device must have a clear view of the sky and be in view of a satellite when it checks for the messages.

You can force a check for messages by manually checking for messages, sending a message, or sending a track point. During a check, your device connects to satellites and receives messages waiting to be sent to your device.

Select **Team Tracking** > **Check**.

Navigating to a Message Location

When you send or receive a message from another device with inReach technology, the message may include location information. For these messages, you can navigate to the location from which the message was sent.

- 1 Select **Team Tracking**, and select a conversation.
- 2 Select a message with location information, and select **Go!**.

Deleting a Message

- 1 Select **Team Tracking**.
- 2 Select a conversation.
- 3 Select **Delete** > **Yes**.

SOS

WARNING

Before you can use the SOS function, you must have an active satellite subscription. Always test your device before you use it outdoors.

Ensure you have a clear view of the sky when using the SOS function, because this feature requires satellite access to operate properly.

NOTICE

Some jurisdictions regulate or prohibit the use of satellite communications devices. It is the responsibility of the user to know and follow all applicable laws in the jurisdictions where the device is intended to be used.

During an emergency, you can use your Tread XL device to contact the Garmin ResponseSM center to request help. Pressing the SOS button sends a message to the Garmin Response team, and they notify the appropriate emergency responders of your situation. You can communicate with the Garmin Response team during your emergency while you wait for help to arrive. You should only use the SOS function in a real emergency situation.

Initiating an SOS Rescue

⚠ CAUTION

While the device is in SOS mode, do not turn off or attempt to turn off the device. Doing so could prevent this feature from operating properly and could delay receipt of assistance in the event of an emergency.

- 1 Open the SOS door on the device ①.

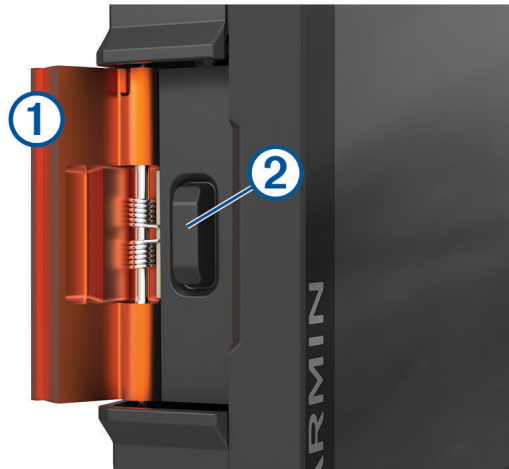

- 2 Press the SOS button ②.
- 3 Wait for the SOS countdown.
The device sends a default message to the emergency response service with details about your location.
- 4 Reply to the confirmation message from the emergency response service.
Your reply lets the emergency response service know that you are capable of interacting with them during the rescue.
For the first 10 minutes of your rescue, an updated location is sent to the emergency response service every minute. To conserve battery power after the first 10 minutes, an updated location is sent every 10 minutes when moving, and every 30 minutes when stationary.

Canceling an SOS Rescue

If you no longer need assistance, you can cancel an SOS rescue after it is sent to the emergency response service.

Select **Cancel SOS**.

Your device transmits the cancellation request. When you receive a confirmation message from the emergency response service, the device returns to normal operation.

Contacts

You can add, delete, and edit contacts on the Tread XL device.

Adding a Contact

- 1 Select **Team Tracking** >  > **inReach Contacts** > **New Contact**.
- 2 Enter the new information.
- 3 Select **Save**.

Editing a Contact

- 1 Select **Team Tracking** >  > **inReach Contacts**.
- 2 Select a contact.
- 3 Select an item to edit.
- 4 Enter the new information.
- 5 Select **Save**.

Deleting a Contact





- 1 Select **Team Tracking** >  > **inReach Contacts**.
- 2 Select a contact.
- 3 Select  > **Yes**.

Viewing Plan and Usage Details

Select **Team Tracking** >  > **About This Device**.

Using the Map

You can use the map to navigate a route ([Your Route on the Map, page 40](#)) or to view a map of your surroundings when no route is active.

- 1 Select **Chase Map**.
- 2 Touch anywhere on the map.
- 3 Select an option:
 - To pan left, right, up, or down, drag the map.
 - To add or remove map layers such as topographic and BirdsEye imagery, select .
 - To zoom in or out, select  or .
 - To switch between map views, select .
 - To start a route, select a location on the map, and select **Go!** ([Starting a Route by Using the Map, page 39](#)).

Map Tools

Map tools provide quick access to information and device functions while you view the map. When you activate a map tool, it appears in a panel at the edge of the map.



Track Recorder: Displays the track data for your active route.

Group Ride: Displays the distance and direction of the members in your group ride ([Group Ride, page 21](#)).

Radio: Allows you to use the push-to-talk feature with a compatible Bluetooth headset ([Enabling Push-to-Talk with a Headset, page 24](#)).

inReach Team Tracking: Allows you to view and send inReach messages, and start inReach team tracking ([Team Tracking Using Built-in inReach Technology, page 25](#)).



Viewing a Map Tool

- 1 From the map, select .
- 2 Select a map tool.
The map tool appears in a panel at the edge of the map.
- 3 When you are done using the map tool, select .

Customizing the Map

Customizing the Map Layers

You can customize which data appear on the map, such as topographic maps and BirdsEye imagery.

- 1 Select  > **Tools** >  > **Map Display** > **Map Layers**.
- 2 Select the check box next to each layer you want to show on the map.

Viewing the Public Lands Map Key

Public lands are color-coded on the map to show who owns a specific plot of land. For example, you can see if a plot of land is privately owned or if it is part of a national park. You must enable the public lands map layer to use this feature ([Customizing the Map Layers, page 30](#)).

You can view the legend for these colors on the device.

- Select  > **Map Display** > **Map Layers** >  > **Public Lands**.

Enabling Adventure Roads and Trails Map Layers

You can enable or disable map layers that display accessible or inaccessible roads for different types of motor vehicles.

- 1 Select  > **Tools** >  > **Map Display** > **Map Layers** >  > **Adventure Roads & Trails**.
- 2 Select a road or trail type.



Changing the Map Data Field

- 1 From the map, select a data field.
NOTE: You cannot customize Speed.
- 2 Select a type of data to display.

Changing the Map Buttons

- 1 From the map, hold a map button.
- 2 Select an option:
 - To replace a map button, select a map button, and select a map button to display.
 - To remove a map button, select .
- 3 Select **Save**.

Changing the Map Perspective

- 1 Select  > **Tools** >  > **Map Display** > **Driving Map View**.
- 2 Select an option:
 - Select **Track Up** to display the map in two dimensions (2D), with your direction of travel at the top.
 - Select **North Up** to display the map in 2D with north at the top.
 - Select **3-D** to display the map in three dimensions.
 - Select **Auto Zoom to Group** to automatically adjust the zoom level so all riders in a group ride are visible on the map.
NOTE: This setting is available only while using the group ride feature.
- 3 Select **Save**.

Using the Apps

Viewing the Owner's Manual on Your Device

You can view the complete owner's manual on the device screen in many languages.

- 1 Select  > **Tools** > **Owner's Manual**.

The owner's manual appears in the same language as the software text.

- 2 Select  to search the owner's manual (optional).

BirdsEye Imagery

BirdsEye imagery provides downloadable, high-resolution map imagery, including detailed satellite imagery and raster-based topographical maps. You can download BirdsEye Satellite Imagery directly to your device when it is connected to a Wi-Fi network.

Downloading BirdsEye Imagery

Before you can download BirdsEye imagery directly to your device, you must connect to a wireless network ([Connecting to a Wireless Network, page 51](#)).

- 1 Select  > **Race** > **BirdsEye Direct**.

- 2 Select .

- 3 Select an option:

- To download BirdsEye imagery files for a specific location or area, select **Location**, and select a category.

NOTE: The location defaults to your current location.



- To select an image quality option, select **Detail**.
- To define the size of the area to be shown in the downloaded imagery files, select **Size**, and enter a distance from the selected location.
- To select where to save the downloaded imagery, select **Save To**.

- 4 Select **Download**.

- 5 Enter a name for the downloaded imagery and select **Done**.

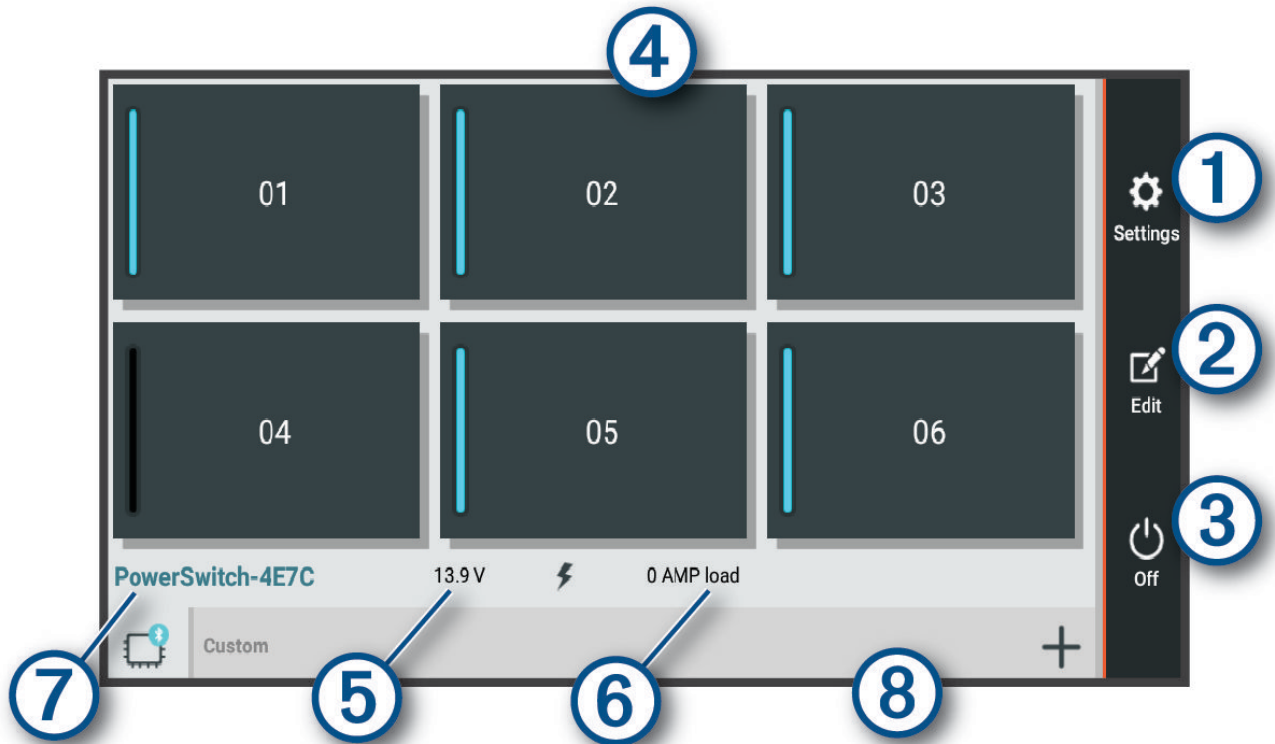
Garmin PowerSwitch™ App



① 	Opens the app settings menu
② 	Enters editing mode to customize the app layout and functions
③ 	Turns off all outputs
④ Power buttons	Activates each connected output
⑤	Displays input voltage
⑥	Displays the total amperage of the selected Garmin PowerSwitch device
⑦	Displays the device name
⑧	Displays Garmin PowerSwitch device tabs and custom layout tabs

Activating a Power Switch



Before you can use the Garmin PowerSwitch app to activate a switch, you must install your Garmin PowerSwitch device in your vehicle and pair it with the Garmin PowerSwitch app.

From the Garmin PowerSwitch app, select a power button to turn a switch on or off.

Turning Off All Switches

Select .

Customizing a Button

- 1 From the Garmin PowerSwitch app screen, select .
The app enters editing mode.
- 2 Select  on the button you want to customize.
- 3 Select an option:
 - To change the name of the button, select the **Button Label** field, and enter a name.
 - To add an icon to the button, select the **Icon** field, and select an icon.
 - To change the button color, select a color.
 - To change the button mode, select a button mode.
 - To adjust the intensity of the switch, use the slider.
 - To set the button to activate with a control input, select a control input.
- 4 Select .
- 5 Select **Done**.

Assigning a Switch to a Control Input



Before you can use control input functions, you must connect a control input to your Garmin PowerSwitch device ([Connecting a Control Input, page 61](#)).

You can assign one or more switches to turn on when the Garmin PowerSwitch device receives a signal from a control input.



- 1 Select .
- 2 Select your Garmin PowerSwitch device.
- 3 Select a control input.
- 4 Select one or more switches.

Adding a Custom Layout



You can add a custom layout tab to the Garmin PowerSwitch app. Buttons added to a custom layout can control multiple switches at the same time.

- 1 From the Garmin PowerSwitch app, select .
The device enters editing mode.
- 2 Select .



Adding a Button to a Custom Layout

- 1 From the Garmin PowerSwitch app, select a custom layout tab.
- 2 Select .
The app enters editing mode.
- 3 Select **Add Button**.
- 4 On the new button, select .
- 5 Select an option:
 - To change the name of the button, select the **Button Label** field, and enter a name.
 - To add an icon to the button, select the **Icon** field, and select an icon.
 - To change the button color, select a color.
- 6 Select **Add Action**.
- 7 If necessary, select a Garmin PowerSwitch device and a switch.
- 8 Select an action:
 - To set the button to turn the switch on or off with each press, select **Toggle**.
 - To set the button to turn on the switch, select **Turn On**.
 - To set the button to turn off the switch, select **Turn Off**.
- 9 Select a button mode:
 - To set the button to activate with one touch, select **Normal**.
 - To set the button to activate only while touching the button, select **Momentary**.
 - To set the button to turn on and off repeatedly, select **Strobe**, and select time intervals.
- 10 If applicable, use the slider to set the brightness of lights.
- 11 Select .
- 12 If necessary, select **Add Action** to add additional actions for the button.
You can add one action for every switch on the Garmin PowerSwitch device.

Arranging Buttons In a Custom Layout

- 1 From the Garmin PowerSwitch app, select a custom layout tab.
- 2 Select .
The app enters editing mode.
- 3 On the button you want to move, hold  and drag the button to a new location.

Deleting a Custom Layout or Button

- 1 From the Garmin PowerSwitch app, select a custom layout tab.
- 2 Select .
The app enters editing mode.
- 3 Select an option:
 - To delete a button, select  on the button you want to delete.
 - To delete a layout tab, select  on the layout tab.



Routines

Routines automate your Garmin PowerSwitch device. When you define a routine on your compatible Garmin navigation device, it turns switches on or off automatically when the conditions of the routine are met. For example, you can set a routine to turn on a switch at specific time each day or when your vehicle reaches a specific speed. Routines are available only when using a compatible Garmin navigation device.



Adding a Routine

- 1 From the Garmin PowerSwitch app, select  > **Routines**.
- 2 If necessary, select **Add Routine**.
- 3 Select **When**.
- 4 Select a trigger:
 - To set a switch to trigger when your vehicle reaches a specific speed, select **Speed** > **Next**, and follow the on-screen instructions to enter speed thresholds.
 - To set a switch to trigger at a specific time each day, select **Time** > **Next**, and enter a time.
 - To set a switch to trigger at sunrise, select **Sunrise**.
 - To set a switch to trigger at sunset, select **Sunset**.
- 5 Select **Add Action**.
- 6 Select a device, a switch, an action, and a button mode.
- 7 If necessary, use the slider to adjust the dimmer.
- 8 Select **Save**.

Editing a Routine

- 1 From the Garmin PowerSwitch app, select  > **Routines**.
- 2 Select  on the routine you want to edit.
- 3 Select an option:
 - To change the trigger for the routine, select **When**, and select a trigger.
 - To change an action, select  on the action you want to change, and update the action.
 - To add an action to the routine, select **Add Action**, and enter information about the action.
- 4 Select **Save**.

Deleting a Routine

- 1 From the Garmin PowerSwitch app, select  > **Routines**.
- 2 Select  on the routine you want to delete.

Tread Audio App

Before you can use the controls in the Tread Audio app, you must install your Tread Audio Box and Tread 6.5" XS-LED Tower Speakers in your vehicle and pair the Tread Audio Box with the Tread Audio app.

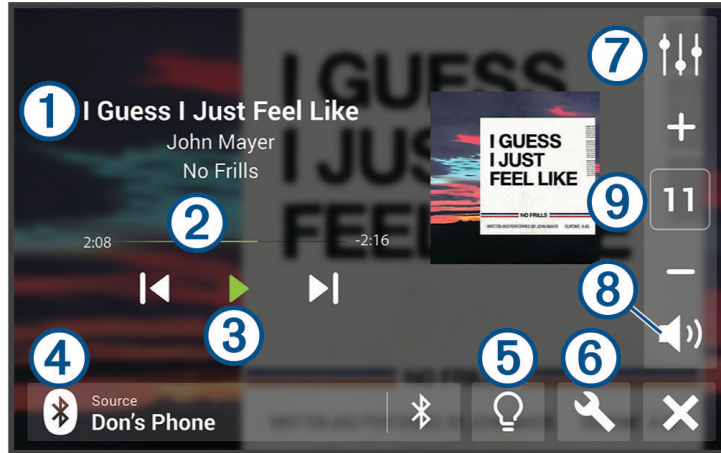

① Displays information about the currently playing media, such as title, artist, album, station, or channel.

② Displays progress through the current media item.

③ Displays playback controls. The controls change based on the service providing the media.

④ Displays the current audio source.  indicates the media is being played by another media app on your phone and sent to the device using a Bluetooth media connection.

⑤ Opens the LED controls.

⑥ Opens the app settings menu.

⑦ Opens the volume zone controls.

⑧ Mutes the audio.

⑨ Increases or decreases the volume.

LED Controls

The LED controls allow you to control the LED lights on your connected Tread 6.5" XS-LED Tower Speakers and optional, addressable LEDs. You can set the color of the LEDs, sync the LEDs to your music or the speed of your vehicle, and display a call sign color during a group ride.

Enabling LED Groups

By default, the controls for LED groups RGB 1 and RGB 2 are enabled. Enabling an LED group allows you to use the LED lighting controls for that group. You can enable the LED group for the Tread 6.5" XS-LED Tower Speakers or any additional speakers or addressable LEDs after you set up and pair them with your Tread Audio Box.

- 1 Select .
- 2 Select the LED group.

Changing the Media Source

You can change the source from which media is played on your device.

- 1 Select the current media source .

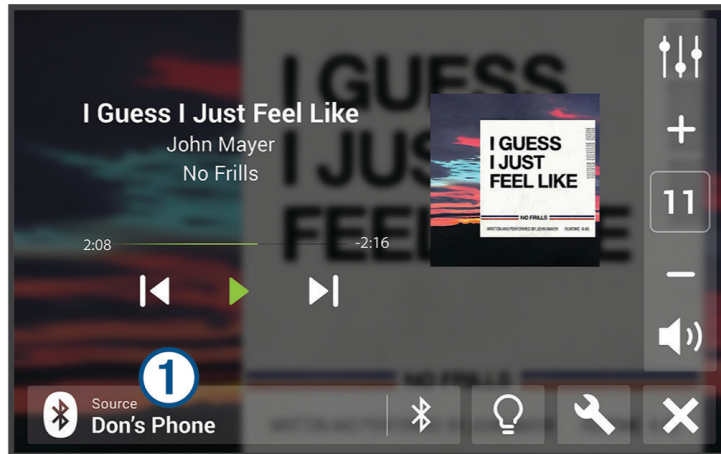

- 2 Select an available media source from the list.

LED Light Settings

Select .

Set Color: Sets the color of the LED lights.

Music Sync: Syncs the LED lights to music playback.

Speed Sync: Syncs the LED lights to the vehicle's speed.

Group Ride Sync: Sets the LED lights to display a call sign color during a group ride.

Audio Zone Settings

Select  > **Stereo Settings** > **Audio Zones**, and if necessary, select a zone.

Zone Name: Sets the name of the zone.

Loud: Boosts the high and low frequencies.

Subwoofer Filter: Sets the low-pass frequency of the subwoofer.

Bass: Sets the relative volume of low-frequency audio.

Middle: Sets the relative volume of middle-frequency audio.

Treble: Sets the relative volume of high-frequency audio.

Pairing with Your Smartphone

You can pair your Tread XL device with your smartphone and the Tread app to enable additional features and access live information.



- 1 From the app store on your smartphone, install the Tread app.
- 2 Turn on your Tread XL device, and place the device and your smartphone within 3 m (10 ft.) of each other.
- 3 On your phone, open the Tread app.
- 4 Follow the on-screen instructions to sign in to a Garmin account and complete the pairing and setup process.

The main app dashboard appears. After the devices are paired, they connect automatically when they are turned on and within range.

Tips After Pairing the Devices



- After the initial pairing, the two devices can connect automatically each time you turn them on.
- When you turn on the device, it tries to connect to the last phone to which it was connected.
- You might need to set your phone to connect to the device automatically when the device is turned on.
- You should verify the Bluetooth features you want to use are enabled ([Enabling or Disabling Bluetooth Features, page 38](#)).

Pairing Additional Bluetooth Devices

- 1 Place your headset or phone and your Bluetooth device within 33 ft. (10 m) of each other.
- 2 On your device, enable Bluetooth wireless technology.
- 3 On your headset or phone, enable Bluetooth wireless technology and ensure it is visible to other Bluetooth devices.
- 4 On your device, select  > **Tools** >  > **Wireless Networks** > **Bluetooth** > **Pair new device**.
A list of nearby Bluetooth devices appears.
- 5 Select your headset or phone from the list.
- 6 If necessary, select **Pair**.



Enabling or Disabling Bluetooth Features

You can enable or disable Bluetooth features such as phone calls, media audio, and live services for your paired smartphone.

- 1 Select  > **Tools** >  > **Wireless Networks** > **Bluetooth**.
- 2 Select your phone name.
- 3 Select a feature to enable or disable it.



Enabling or Disabling Bluetooth Features for Your Headset

By default, all compatible Bluetooth features are enabled when you pair your headset. You can enable or disable certain features.

- 1 Select  > **Tools** >  > **Wireless Networks** > **Bluetooth**.
- 2 Select the headset name, and select .
- 3 Select an option:
 - To disconnect the headset, select **Disconnect**.
 - To disable audio from streaming media, select **Media Audio**.

Disconnecting a Bluetooth Device

You can temporarily disconnect a Bluetooth device without deleting it from the paired devices list. The Bluetooth device can connect to your Tread device automatically in the future.

- 1 Select  > **Tools** >  > **Wireless Networks** > **Bluetooth**.
- 2 Select the device to disconnect.
- 3 Select **Disconnect**.



Deleting a Paired Phone

You can delete a paired phone to prevent it from automatically connecting to your device in the future.

- 1 Select  > **Tools** >  > **Wireless Networks** > **Bluetooth**.
- 2 Select the phone, and select **Forget**.

Street Navigation

Starting a Route

- 1 Select  > **Apps** > **Search**, and search for a location.
- 2 Select a location.
- 3 Select an option:
 - To start navigating using the recommended route, select **Go!**.
 - To choose an alternate route, select , and select a route.
Alternate routes appear to the right of the map.
 - To edit the course of the route, select  > **Edit Route**, and add shaping points to the route ([Shaping Your Route, page 41](#)).

The device calculates a route to the location and guides you using voice prompts and information on the map ([Your Route on the Map, page 40](#)). A preview of the major roads in your route appears at the edge of the map for several seconds.

If you need to stop at additional destinations, you can add the locations to your route ([Adding a Location to Your Route, page 41](#)).

Starting a Route by Using the Map

You can start a route by selecting a location from the map.

- 1 Select **Chase Map**.
- 2 Drag and zoom the map to display the area to search.
- 3 Select a location on the map.
- 4 Select **Go!**.

Your Route on the Map

As you travel, the device guides you to your destination using voice prompts and information on the map. Instructions for your next turn or exit, or other actions appear across the top of the map.

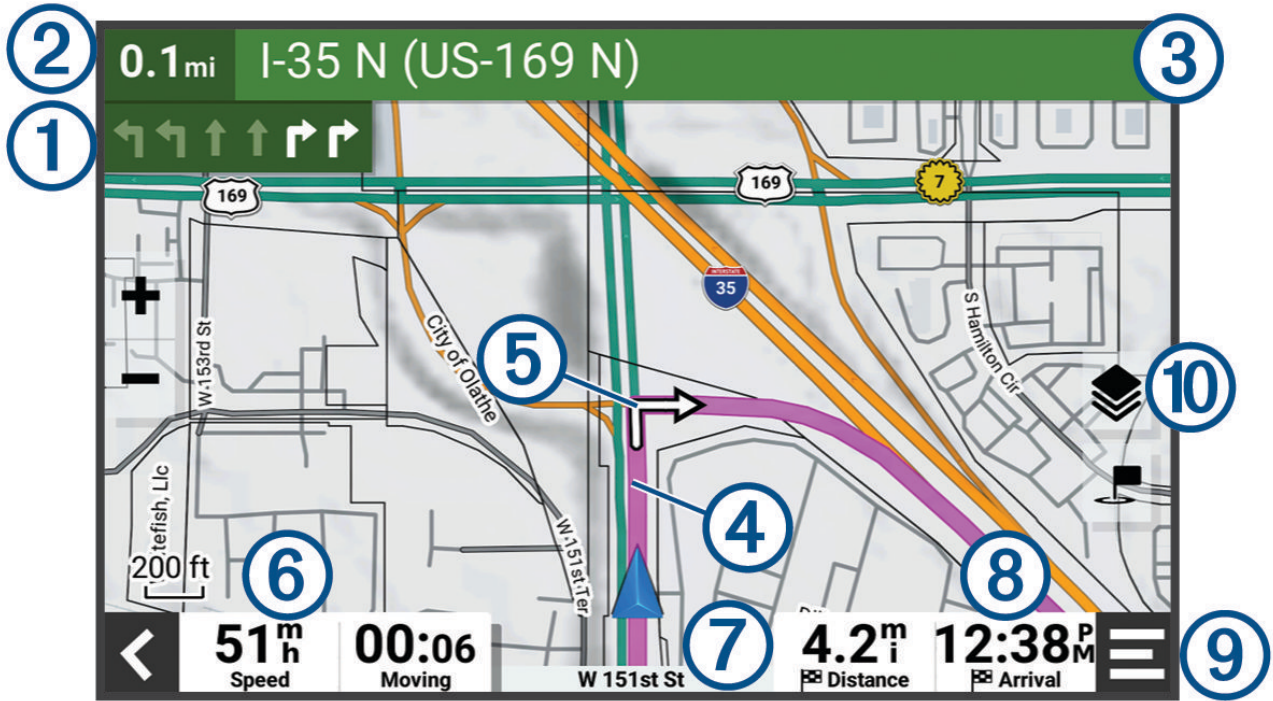

①	Next action in the route. Indicates the next turn, exit, or other action and the lane in which you should travel, if available.
②	Distance to the next action.
③	Name of the street or exit associated with the next action.
④	Route highlighted on the map.
⑤	Next action in the route. Arrows on the map indicate the location of upcoming actions.
⑥	Vehicle speed.
⑦	Name of the road on which you are traveling.
⑧	Estimated arrival time. TIP: You can touch this field to change the information it shows.
⑨	Map tools. Provides tools to show you more information about your route and surroundings.
⑩	Map layers. Allows you to change the map orientation and add topographic and BirdsEye imagery to your map view.

Viewing Turns and Directions

While navigating a route, you can view upcoming turns, lane changes, or other directions for your route.

- 1 Select the text bar at the top of the map.
- 2 Select a turn or direction (optional).

Detailed information appears. An image of the junction may appear for junctions on major roadways, if available.

Viewing the Entire Route on the Map



- 1 While navigating a route, select anywhere on the map.
- 2 Select .

Changing Your Active Route

Adding a Location to Your Route

Before you can add a location to your route, you must be navigating a route ([Starting a Route, page 39](#)).

You can add locations to the middle or end of your route. For example, you can add a fuel station as the next destination in your route.

- 1 From the map, select   **Apps > Search**.
- 2 Search for a location.
- 3 Select a location.
- 4 Select **Go!**.
- 5 Select an option:
 - To add the location as the next destination in your route, select **Add as Next Stop**.
 - To add the location to the end of your route, select **Add as Last Stop**.
 - To add the location and edit the order of destinations in your route, select **Add to Active Route**.

The device re-calculates the route to include the added location and guides you to the destinations in order.

Shaping Your Route

Before you can shape your route, you must start a route ([Starting a Route, page 39](#)).

You can manually shape your route to change its course. This allows you to direct the route to use a certain road or go through a certain area without adding a destination to the route.

- 1 Touch anywhere on the map.
- 2 Select **Shape Route**.

TIP: You can select  to zoom in on the map and select a more precise location.
The device enters route shaping mode and recalculates the route to travel through the selected location.
- 3 Select **Go!**.
- 4 If necessary, select an option:
 - To add more shaping points to the route, select additional locations on the map.
 - To remove a shaping point, select the shaping point and select **Remove**.



Avoiding Delays, Tolls, and Areas

Avoiding Toll Roads

Your device can avoid routing you through areas that require tolls, such as toll roads, toll bridges, or congestion areas. The device may still include a toll area in your route if no other reasonable routes are available.

- 1 Select  **Tools >  > Navigation > Avoidances > Toll Roads**.
- 2 Select **Save**.



Avoiding Road Features

- 1 Select  > **Tools** >  > **Navigation** > **Avoidances**.
- 2 Select the road features to avoid on your routes, and select **Save**.



Custom Avoidances

Custom avoidances allow you to select specific areas or sections of road to avoid. When the device calculates a route, it avoids these areas and roads unless no other reasonable route is available.

Avoiding a Road



- 1 Select  > **Tools** >  > **Navigation** > **Custom Avoidances**.
- 2 If necessary, select **Add Avoidance**.
- 3 Select **Add Avoid Road**.
- 4 Select the starting point of the section of road to avoid, and select **Next**.
- 5 Select the ending point of the road section, and select **Next**.
- 6 Select **Done**.

Avoiding an Area



- 1 Select  > **Tools** >  > **Navigation** > **Custom Avoidances**.
- 2 If necessary, select **Add Avoidance**.
- 3 Select **Add Avoid Area**.
- 4 Select the upper-left corner of the area to avoid, and select **Next**.
- 5 Select the lower-right corner of the area to avoid, and select **Next**.
The selected area is shaded on the map.
- 6 Select **Done**.

Disabling a Custom Avoidance

You can disable a custom avoidance without deleting it.



- 1 Select  > **Tools** >  > **Navigation** > **Custom Avoidances**.
- 2 Select an avoidance.
- 3 Select  > **Disable**.

Deleting Custom Avoidances



- 1 Select  > **Tools** >  > **Navigation** > **Custom Avoidances** > .
- 2 Select an option:
 - To delete all custom avoidances, select **Select All** > **Delete**.
 - To delete one custom avoidance, select the avoidance, and select **Delete**.

Arriving at Your Destination

When you approach your destination, the device provides information to help you complete your route.



-  indicates the location of your destination on the map, and a voice prompt announces you are approaching your destination.
- When you approach some destinations, the device automatically suggests parking areas. You can select **More** to view a full list of suggested parking areas ([Parking Near Your Destination, page 43](#)).
- When you stop at your destination, the device automatically ends the route. If the device does not detect your arrival automatically, you can select  > **Stop** to end your route.

Changing the Route Calculation Mode

- 1 Select  > **Tools** >  > **Navigation** > **Calculation Mode**.
- 2 Select an option:
 - Select **Turn-by-Turn** to calculate routes on streets and trails.
 - Select **Straight Line** to calculate off-road, point-to-point routes in a straight line.

Taking a Route Using Garmin Adventurous Routing™

Your device can calculate adventurous routes that prefer curvy roads, hills, and fewer highways. This feature can provide a more enjoyable ride, but it may increase the time or distance to your destination.

- 1 Select  > **Apps** > **Search**, and search for a location.
- 2 Select a location.
- 3 Select .
- 4 Use the slider to increase or decrease the level of adventure of your route.
- 5 Select **Go!**.

Taking a Detour

You can take a detour for a specified distance along your route or detour around specific roads. This is useful if you encounter construction zones, closed roads, or poor road conditions.



- 1 From the map, select  > **Edit Route**.
- 2 Select an option:
 - To detour your route for a specific distance, select **Detour by Distance**.
 - To detour around a specific road on the route, select **Detour by Road**.

Going Home

The first time you start a route home, the device prompts you to enter your home location.



- 1 Select  > **Apps** > **Search** > **Go Home**.
- 2 If necessary, enter your home location.

Editing Your Home Location

- 1 Select  > **Apps** > **Search** >  > **Set Home Location**.
- 2 Enter your home location.

Parking Near Your Destination

Your device can help you find a parking spot near your destination. When you approach some destinations, the device automatically suggests parking areas.

- 1 Select an option:
 - When the device suggests parking, select **More** to see all suggested parking areas.
NOTE: When you select a suggested parking area, the device automatically updates your route.
 - If the device does not suggest parking locations, select  > **Apps** > **Search** > **Categories** > **Parking**, and select  > **My Destination**.
- 2 Select a parking location, and select **Go!**.

The device guides you to the parking area.

Finding and Saving Locations



The maps loaded in your device contain locations, such as restaurants, hotels, auto services, and detailed street information. The Search menu helps you find your destination by providing several methods to browse, search, and save this information.

From the main menu, select **Search**.

- To quickly search all locations on your device, select **Search** (*Finding a Location Using the Search Bar, page 44*).
- To find an address, select **Address**.
- To browse or search pre-loaded points of interest by category, select **Categories** (*Finding a Location by Category, page 45*).
- To search near a different city or area, select  next to the current search area (*Changing the Search Area, page 45*).
- To view and edit your saved locations, select **Waypoints** (*Saving Locations, page 49*).
- To view locations you have recently selected from the search results, select **Recent** (*Viewing Recently Found Locations, page 48*).
- To browse and search Tripadvisor® traveler ratings, select **Tripadvisor** (*Finding Tripadvisor Points of Interest, page 47*).
- To find national parks and explore park maps, select **National Parks** (*Finding National Parks, page 46*).
- To navigate to specific geographic coordinates, select **Coordinates** (*Finding a Location Using Coordinates, page 48*).

Finding a Location Using the Search Bar

You can use the search bar to search for locations by entering a category, brand name, address, or city name.

- 1 Select  > **Apps** > **Search**.
- 2 Select **Search** in the search bar.
- 3 Enter all or part of the search term.
Suggested search terms appear below the search bar.
- 4 Select an option:
 - To search for a type of business, enter a category name (for example, "movie theaters").
 - To search for a business name, enter all or part of the name.
 - To search for an address near you, enter the house number and street name.
 - To search for an address in another city, enter the house number, street name, city, and state.
 - To search for a city, enter the city and state.
 - To search for coordinates, enter latitude and longitude coordinates.
- 5 Select an option:
 - To search using a suggested search term, select the term.
 - To search using the text you entered, select .
- 6 If necessary, select a location.

Location Search Results

The location search results appear in a list, with the nearest location at the top. Each numbered location also appears on the map. You can scroll down to view more results.

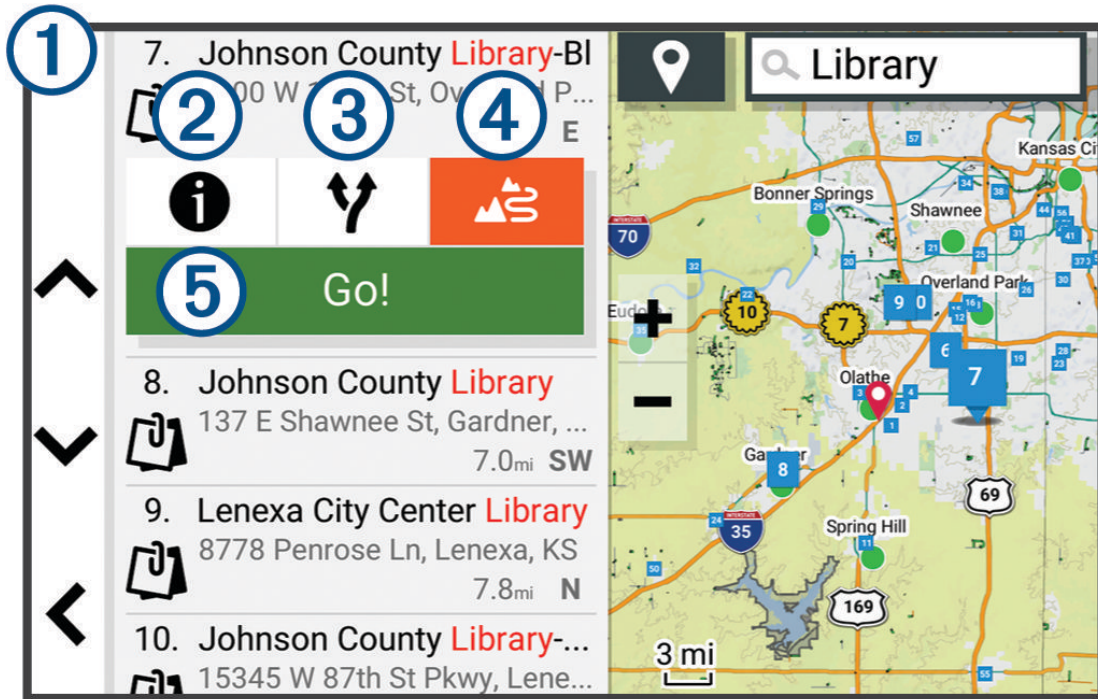

①	Select a location to view the option menu.
② ⓘ	Select to view detailed information about the location.
③ ↻	Select to view alternate routes to the location.
④ 🗺️	Select to start navigating using Garmin Adventurous Routing.
⑤ Go!	Select to start navigating to the location using the recommended route.

Changing the Search Area

By default, the device searches near your current location. You can also search other areas, such as near your destination, near another city, or along your active route.

- 1 Select > **Apps** > **Search**.
- 2 Select .
- 3 Select an option.



Finding a Location by Category

- 1 Select > **Apps** > **Search**.
- 2 Select a category, or select **Categories**.
- 3 If necessary, select a subcategory.
- 4 Select a location.

Navigating to Points of Interest Within a Venue

NOTE: This feature may not be available in all areas or for all product models.

You can create a route to a point of interest (POI) within a larger venue, such as a store in a shopping mall or a specific terminal in an airport.

- 1 Select  > **Apps** > **Search** > **Search**.
- 2 Enter the name of the venue, and select .
- 3 Select the venue.
A list of categories for POIs within the venue appears.
- 4 Select a category, select a location, and select **Go!**.

The device creates a route to the parking area or venue entrance closest to the POI. When you arrive at the destination, a checkered flag indicates the recommended parking area. A labeled point indicates the location of the POI within the venue.

Points of Interest



A point of interest is a place that you may find useful or interesting. Points of interest are organized by category and can include popular travel destinations such as gas stations, restaurants, hotels, and entertainment venues.

Finding National Parks

Device models that include maps for North America or the United States also include detailed information for national parks in the United States. You can navigate to a national park or to a location within a national park.

NOTICE

You are responsible for understanding and complying with any applicable rules, laws, or regulations associated with national parks.

- 1 Select  > **Apps** > **Search** > **National Parks**.
A list of national parks appears, with the nearest park at the top.
- 2 Select **Search**, and enter all or part of the park name to narrow the results (optional).
- 3 Select a national park.
A list of categories for locations of features and amenities within the park appears below the park name.
- 4 Select an option:
 - To start navigating to the park, select **Go!**.
 - To view more park information or explore the park features and amenities, select .
 - To quickly find a location within the park, select a category from the list below the park name, and select a location.

Finding Campgrounds

NOTICE

You are responsible for understanding and complying with any applicable rules, laws, or regulations associated with campgrounds.

Select  > **Apps** > **Search** > **Categories** > **All Campgrounds**.

Finding Ultimate Campgrounds Points of Interest

NOTE: This feature is not available in all areas.

NOTICE

You are responsible for understanding and complying with any applicable rules, laws, or regulations associated with campsites and points of interest.

Your device includes Ultimate Campgrounds points of interest, which allow you to find public campgrounds near your location.

- 1 Select  > **Apps** > **Search** > **Ultimate Public Campgrounds**.
- 2 If necessary, select **Search Filters**, select one or more search filters, and select **Search**.
- 3 Select a location.

Finding iOverlander™ Points of Interest

NOTICE

You are responsible for understanding and complying with any applicable rules, laws, or regulations associated with campsites and points of interest.

Your device includes iOverlander points of interest, which allow you to find points of interest useful for overlanding, such as camp sites, repair services, and lodging.

- 1 Select  > **Apps** > **Search** > **iOverlander**.
- 2 Select a category.
- 3 Select a location.

Finding Adventure Points

NOTICE

You are responsible for understanding and complying with any applicable rules, laws, or regulations associated with campsites and points of interest.

Your device includes adventure points of interest, which allow you to find outdoor points of interest such as campsites, hiking trails, OHV trails, fishing locations, and water activities.

- 1 Select  > **Apps** > **Search** > **USFS Adventure Points**.
- 2 If necessary, select **Search Filters**, select one or more search filters, and select **Save**.
- 3 Select a location.

Tripadvisor



NOTICE

Garmin is not responsible for the accuracy or timeliness of the Tripadvisor information.

You are responsible for understanding and complying with any applicable rules, laws, or regulations associated with points of interest.

Your device includes Tripadvisor traveler ratings. Tripadvisor ratings appear automatically in the search results list for restaurants, hotels, and attractions. You can also search for nearby Tripadvisor points of interest and sort by distance or popularity.

Finding Tripadvisor Points of Interest

- 1 Select  > **Apps** > **Search** > **Tripadvisor**.
- 2 Select a category.
- 3 If necessary, select a subcategory.
A list of nearby Tripadvisor points of interest for the category appears.
- 4 Select **Sort Results** to filter the displayed points of interest by distance or popularity (optional).
- 5 Select , and enter a search term (optional).

Finding Parking Near Your Current Location



- 1 Select  > **Apps** > **Search** > **Categories** > **Parking**.
- 2 Select a parking location.
- 3 Select **Go!**.

Search Tools

Search tools allow you to search for specific types of locations by responding to on-screen prompts.



Finding an Address

NOTE: The order of the steps may change depending on the map data loaded on your device.

- 1 Select  > **Apps** > **Search**.
- 2 If necessary, select  to search near a different city or area.
- 3 Select **Address**.
- 4 Follow the on-screen instructions to enter address information.
- 5 Select the address.

Finding a Location Using Coordinates

You can find a location using latitude and longitude coordinates.

- 1 Select  > **Apps** > **Search** > **Coordinates**.
- 2 If necessary, select , and change the coordinate format or datum.
- 3 Select **Coordinates**.
- 4 Enter the latitude and longitude coordinates, and select **Done**.
- 5 Select an option:
 - To save the coordinates as a location, select **Save**.
 - To start a route to the coordinates, select **Go!**.

Viewing Recently Found Locations

Your device stores a history of the last 50 locations you have found.

Select  > **Apps** > **Search** > **Recent**.

Clearing the List of Recently Found Locations

Select  > **Apps** > **Search** > **Recent** >  > **Clear** > **Yes**.

Viewing Current Location Information

You can use the Where Am I? page to view information about your current location. This feature is helpful if you need to tell emergency personnel your location.

From the map, select the vehicle.

Finding Emergency Services and Fuel

You can use the Where Am I? page to find the nearest hospitals, police stations, and fuel stations.

1 From the map, select the vehicle.

2 Select **Hospitals**, **Police Stations**, or **Fuel**.

NOTE: Some service categories are not available in all areas.

A list of locations for the selected service appears, with the nearest locations at the top.

3 Select a location.

4 Select an option:

- To navigate to the location, select **Go!**.
- To view the phone number and other location details, select **i**.

Getting Directions to Your Current Location

If you need to tell another person how to get to your current location, your device can give you a list of directions.

1 From the map, select the vehicle.

2 Select  > **Directions to Me**.

3 Select a starting location.

4 Select **Select**.

Adding a Shortcut

You can add shortcuts to the Where To? menu. A shortcut can point to a location, a category, or a search tool.

The Where To? menu can contain up to 36 shortcut icons.

1 Select  > **Apps** > **Search** > **Add Shortcut**.

2 Select an item.

Removing a Shortcut

1 Select  > **Apps** > **Search** >  > **Remove Shortcut(s)**.

2 Select a shortcut to remove.

3 Select the shortcut again to confirm.

4 Select **Done**.

Saving Locations

Saving a Location

1 Search for a location ([Finding a Location by Category, page 45](#)).

2 From the search results, select a location.

3 Select **i** > **Save**.

4 If necessary, enter a name, and select **Done**.

5 Select **Save**.



Saving a Waypoint on the Map

- 1 Select **Chase Map**.
- 2 Drag and zoom the map to display the area to search.
- 3 Select an option:
 - Select a location marker.
 - Select a point, such as a street, intersection, or address location.
- 4 Select .
- 5 Enter a name, and select **Save**.

Saving Your Current Location

- 1 From the map, select the vehicle icon.
- 2 Select **Save**.
- 3 Enter a name, and select **Done**.



Editing a Saved Location

- 1 Select  > **Apps** > **Search** > **Waypoints**.
- 2 If necessary, select a category.
- 3 Select a location.
- 4 Select .
- 5 Select  > **Edit**.
- 6 Select an option:
 - Select **Name**.
 - Select **Phone Number**.
 - Select **Categories** to assign categories to the saved location.
 - Select **Map Symbol** to change the symbol used to mark the saved location on a map.
- 7 Edit the information.
- 8 Select **Done**.

Assigning Categories to a Saved Location

You can add custom categories to organize your saved locations.

NOTE: Categories appear in the saved locations menu after you have saved at least 12 locations.

- 1 Select  > **Apps** > **Search** > **Waypoints**.
- 2 Select a location.
- 3 Select .
- 4 Select  > **Edit** > **Categories**.
- 5 Enter one or more category names, separated by commas.
- 6 If necessary, select a suggested category.
- 7 Select **Done**.

Deleting a Saved Location

NOTE: Deleted locations cannot be recovered.

- 1 Select  > **Apps** > **Search** > **Waypoints**.
- 2 Select a waypoint.
- 3 Select **Edit** > **Delete** > **Yes**.

Settings

Navigation Settings

Select  > **Tools** >  > **Navigation**.

Calculation Mode: Sets the route calculation method.

Off-Route Recalculation: Sets recalculation preferences when navigating away from an active route.

Avoidances: Sets road features to avoid on a route.

Custom Avoidances: Allows you to avoid specific roads or areas.

Environmental Zones: Sets the avoidance preferences for areas with environmental or emissions restrictions that may apply to your vehicle.

Restricted Mode: Disables all functions that require significant operator attention.

Voice Language: Sets the language for navigation voice prompts.

Travel History: Allows the device to store a record of the places you go. This allows you to view the trip log, use the Trip History feature, and use myTrends™ suggested routes.

Clear Travel History: Allows you to clear all travel history from the device.

Map Display Settings

Select  > **Tools** >  > **Map Display**.

Map Vehicle Icon: Sets the vehicle icon that represents your position on the map.

Driving Map View: Sets the perspective on the map.

Map Detail: Sets the level of detail on the map. More detail may cause the map to draw slower.

Map Theme: Changes the color of the map data.

Map Layers: Sets the data that appears on the map page (*Customizing the Map Layers, page 30*).

Adventure Roads & Trails: Sets the trails visible on the map. Trails are organized by vehicle accessibility.

Waypoint Decluttering: Hides waypoints at high map zoom levels.

Auto Zoom: Automatically selects the zoom level for optimal use of your map. When disabled, you must zoom in or out manually.

Skip Next Stop Confirmation: Sets a confirmation message to appear when skipping a location on your route.

Units: Sets the units of measure.

myMaps: Sets which installed maps the device uses.

Enabling Maps



You can enable map products installed on your device.

TIP: To purchase additional map products, go to garmin.com/maps.

1 Select  > **Tools** >  > **Map Display** > **myMaps**.

2 Select a map.

Connecting to a Wireless Network

1 Select  > **Tools** >  > **Wireless Networks** > **Wi-Fi**.

2 If necessary, select the toggle switch to turn on wireless network technology.

3 Select a wireless network.

4 If necessary, enter the encryption key.

The device connects to the wireless network. The device remembers the network information and connects automatically when you return to this location in the future.

Enabling Bluetooth Wireless Technology

Select  > **Tools** >  > **Wireless Networks** > **Bluetooth**.

Display Settings

Select  > **Tools** >  > **Device** > **Display**.

Brightness level: Sets the display brightness level on your device.

Dark theme: Enables or disables the dark color theme.

Wallpaper: Sets the wallpaper background on your device.

Screen timeout: Allows you to set the amount of idle time before your device turns off the display while using battery power.

Font size: Increases or decreases the font size on your device.

Auto-rotate screen: Enables the screen to rotate automatically between portrait and landscape display modes based on the device orientation or to remain in the current orientation.

Adjusting Sound and Notification Volume

1 Select  > **Tools** >  > **Device** > **Sound & Notification**.

2 Use the sliders to adjust the sound and notification volume.

Setting the Text Language

You can select the language for text in the device software.

1 Select  > **Tools** >  > **Personal** > **Language & Input** > **Languages**.

2 Select a language.

Date and Time Settings

Select  > **Tools** >  > **System** > **Date & Time**.

Use network-provided time: Automatically sets the time zone based on information from the connected network.

Use network-provided time zone: Sets the time zone on your device when the Use network-provided time setting is disabled.

Use 24-hour format: Enables or disables the 24-hour time format.

Device Settings

Select  > **Tools** >  > **About Device**.

Legal Information: Allows you to view the end-user license agreement (EULA) and software license information.

Regulatory Information: Displays e-label regulatory and compliance information.

Garmin Device Information: Displays hardware and software version information.

Enabling or Disabling Location Services

The location services feature must be enabled for your device to find your location, calculate routes, and provide navigational assistance. You can disable location services to plan a route when GPS signals are not available. When location services are disabled, the device enables a GPS simulator to calculate and simulate routes.

TIP: Disabling location services can help save battery power.

1 Select  > **Tools** >  > **Personal** > **Location**.

2 Select the toggle switch to enable or disable location services.

Device Information

Viewing E-label Regulatory and Compliance Information

1 From the settings menu, swipe to the bottom of the menu.

2 Select **About Device** > **Regulatory Information**.

Specifications

Water and dust resistance	IEC 60529 IP67 ¹
Operating temperature range	From -20° to 55°C (from -4° to 131°F)
Charging temperature range	From 0° to 45°C (from 32° to 113°F)
Power input (vehicle power cable or external power)	From 12 to 30 Vdc
Battery type	Lithium-ion battery
Battery voltage range	From 3.5 to 4.1 V
Wireless frequencies and transmit power	2.4 Ghz @ 9.5 dBm maximum 5.1 Ghz @ 12.8 dBm maximum 5.7 GHz @ 13.22 dBm maximum 5.2 Ghz @ 15.6 dBm maximum 1.6 Ghz @ 31.7 dBm maximum
EU SAR	0.74 W/kg torso, 0.74 W/kg limb

Charging the Device

NOTE: This Class III product shall be powered by an LPS power supply.

You can charge the battery in the device using any of these methods.

- Install the device in the mount, and connect the mount to vehicle power.
- Connect the device to an optional power adapter accessory, such as a wall power adapter.

You can purchase an approved Garmin AC-DC adapter suitable for home or office use from a Garmin dealer or www.garmin.com. The device may charge slowly when connected to a third-party adapter.

Device Maintenance

Garmin Support Center

Go to support.garmin.com for help and information, such as product manuals, frequently asked questions, videos, and customer support.

Map and Software Updates

For the best navigation experience, you should keep the maps and software on your device up to date.

Map updates provide the newest available changes to roads and locations in the maps used by your device. Keeping maps up to date helps your device find recently added locations and calculate more accurate routes. Map updates are large and may take several hours to complete.

Software updates provide changes and improvements to the device features and operation.

You can update your device using two methods.

- You can connect the device to a Wi-Fi network to update directly on the device (recommended). This option allows you to update your device conveniently without connecting it to a computer.
- You can connect the device to a computer and update it using the Garmin Express™ application (garmin.com/express).

¹ The device is protected against the ingress of dust and withstands incidental exposure to water of up to 1 m for up to 30 min.

Updating Maps and Software Using a Wi-Fi Network

NOTICE

Map and software updates may require the device to download large files. Regular data limits or charges from your internet service provider apply. Contact your internet service provider for more information about data limits or charges.

You can update the maps and software by connecting your device to a Wi-Fi network that provides access to the internet. This allows you to keep your device up to date without connecting it to a computer.



- 1 Using the included USB cable, connect the device to external power.

NOTE: A USB power adapter is not included. Go to the product page on garmin.com to purchase a power adapter accessory.

- 2 Connect the device to a Wi-Fi network (*Connecting to a Wireless Network*, page 51).

While connected to a Wi-Fi network, the device checks for available updates automatically and displays a notification when an update is available.

- 3 Select an option:

- When an update notification appears, swipe down from the top of the screen, and select **An update is available..**
- To manually check for updates, select  > **Tools** >  > **Updates**.

The device displays available map and software updates. When an update is available, **Update Available** appears below Map or Software.

- 4 Select an option:

- To install all available updates, select **Download**.
- To install only map updates, select **Map**.
- To install only software updates, select **Software**.

- 5 If necessary, read the license agreements, and select **Accept All** to accept the agreements.

NOTE: If you do not agree with the license terms, you can select **Reject**. This stops the update process. You cannot install updates until you accept the license agreements.

- 6 Keep the device connected to external power and within range of the Wi-Fi network until the update process is complete.

NOTE: If a map update is interrupted or canceled before it completes, your device may be missing map data. To repair missing map data, you must update the maps again.

Product Updates



On your computer, install Garmin Express (www.garmin.com/express).

This provides easy access to these services for Garmin devices:

- Software updates
- Map updates
- Product registration

Updating Maps and Software with Garmin Express

You can use the Garmin Express application to download and install the latest map and software updates for your device.

- 1 If you do not have the Garmin Express application installed on your computer, go to garmin.com/express and follow the on-screen instructions to install it.
- 2 Open the  Garmin Express application.
- 3 Connect your device to your computer using a USB cable.
The small end of the cable connects to the USB port  on your Tread XL device, and the large end connects to an available USB port on your computer.



- 4 In the Garmin Express application, click **Add a Device**.
The Garmin Express application searches for your device and displays the device name and serial number.
- 5 Click **Add Device**, and follow the on-screen instructions to add your device to the Garmin Express application.
When setup is complete, the Garmin Express application displays the updates available for your device.

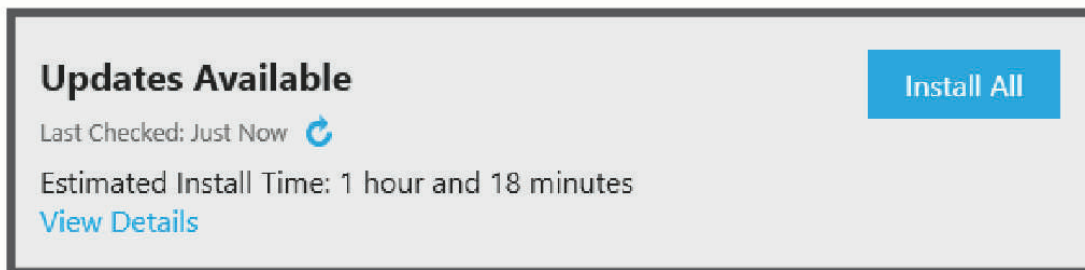

- 6 Select an option:
 - To install all available updates, click **Install All**.
 - To install a specific update, click **View Details**, and click **Install** next to the update you want.The Garmin Express application downloads and installs the updates onto your device. Map updates are very large, and this process may take a long time on slower internet connections.
NOTE: If a map update is too large for the internal storage of the device, the software may prompt you to install a microSD card in your device to add storage space (*Installing a Memory Card for Maps and Data*, page 77).
- 7 Follow the on-screen instructions during the update process to finish installing updates.
For example, during the update process, the Garmin Express application may instruct you to disconnect and reconnect your device.

Device Care

NOTICE

Avoid dropping your device.

Do not store the device where prolonged exposure to extreme temperatures can occur, because it can cause permanent damage.

Never use a hard or sharp object to operate the touchscreen, or damage may result.

Cleaning the Outer Casing

NOTICE

Avoid chemical cleaners and solvents that can damage plastic components.

- 1 Clean the outer casing of the device (not the touchscreen) using a cloth dampened with a mild detergent solution.
- 2 Wipe the device dry.

Cleaning the Touchscreen

- 1 Use a soft, clean, lint-free cloth.
- 2 If necessary, lightly dampen the cloth with water.
- 3 If using a dampened cloth, turn off the device and disconnect the device from power.
- 4 Gently wipe the screen with the cloth.

Avoiding Theft

- Remove the device and mount from sight when not in use.
- Remove the residue left on the windshield by the suction cup.
- Do not keep your unit in the glove compartment.
- Register your device using the Garmin Express software (garmin.com/express).

Restarting the Device

You can restart your device if it stops functioning.

Hold the power button for 12 seconds.

Troubleshooting

My device is not acquiring satellite signals

- Verify the location services feature is enabled (*Enabling or Disabling Location Services*, page 52).
- Take your device out of parking garages and away from tall buildings and trees.
- Remain stationary for several minutes.

My battery does not stay charged for very long

- Decrease the screen brightness (*Display Settings*, page 52).
- Shorten the display timeout (*Display Settings*, page 52).
- Decrease the volume (*Adjusting Sound and Notification Volume*, page 52).
- Turn off the wi-fi radio when it is not in use (*Connecting to a Wireless Network*, page 51).
- Put the device in power saving mode when not in use (*Turning the Device On or Off*, page 4).
- Keep your device away from extreme temperatures.
- Do not leave your device in direct sunlight.

My device does not connect to my phone

- Enable Bluetooth wireless technology on your phone, and bring your phone within 10 m (33 ft.) of the device.
- Verify your phone is compatible.
Go to www.garmin.com/bluetooth for more information.
- Complete the pairing process again.
To repeat the pairing process, you must unpair your phone and device (*Disconnecting a Bluetooth Device*, page 39), and complete the pairing process (*Pairing with Your Smartphone*, page 38).

My device does not appear as a removable drive on my computer

On most computers, the device connects using Media Transfer Protocol (MTP). In MTP mode, the device appears as a portable device and not as a removable drive.

Appendix

Garmin PowerSwitch

WARNING

Garmin strongly recommends having an experienced installer with the proper knowledge of electrical systems install the device. Incorrectly wiring the power cable can result in damage to the vehicle or the battery and can cause bodily injury.

You can use a connected Garmin PowerSwitch device to control lights, fans, and more from your Tread XL device.

Mounting Considerations

- The device must be mounted close to the battery and within the range of the supplied power cable.
- The mounting surface must be strong enough to support the weight of the device.
- The location must allow room for the routing and connection of all cables.

Mounting the Device

Before you can mount the device, you must select a mounting location and purchase the appropriate hardware for your mounting surface.

NOTICE

Avoid wires, gauges, air bags, air bag covers, HVAC, and other items when drilling pilot holes and attaching the mount to the vehicle. Garmin is not responsible for any damages or consequences arising from the installation.

- 1 Place the mount on the selected location.



- 2 Using the mount as a template, mark the two screw locations ①.
- 3 Drill pilot holes (optional).
For some types of mounting material, drilling pilot holes is necessary. Do not drill through the mount.
- 4 Securely fasten the mount to the surface using the appropriate hardware for your mounting surface.

Opening the Front Cover

You must open the front cover to make electrical connections.

- 1 Lift the front cover latch ① and rotate it counter-clockwise.



- 2 Pull the front cover off of the device.



Connecting Accessories

NOTICE

Do not use the device to control or power a winch. Failure to follow this notice could cause damage to your vehicle or your device.

Do not connect a power source to an accessory output terminal. Failure to follow this notice could cause damage to your vehicle or your device.

Accessory requirements:

- Verify the amperage rating of each accessory before wiring it to the Garmin PowerSwitch device. The device supports accessories up to 30 A for each channel and a maximum of 100 A for the entire system.
- Use 10 AWG (6 mm²) wires for accessories that use 20 to 30 A.
- Use 12 AWG (4 mm²) wires for accessories that use 10 to 20 A.
- Use 14 AWG (2.5 mm²) wires for accessories that use less than 10 A.
- Use the appropriate size terminals for all accessory connections.
- Crimp all terminal connectors securely.

- 1 Connect the positive wire from the accessory ① to one of the accessory terminals ② on the Garmin PowerSwitch device.

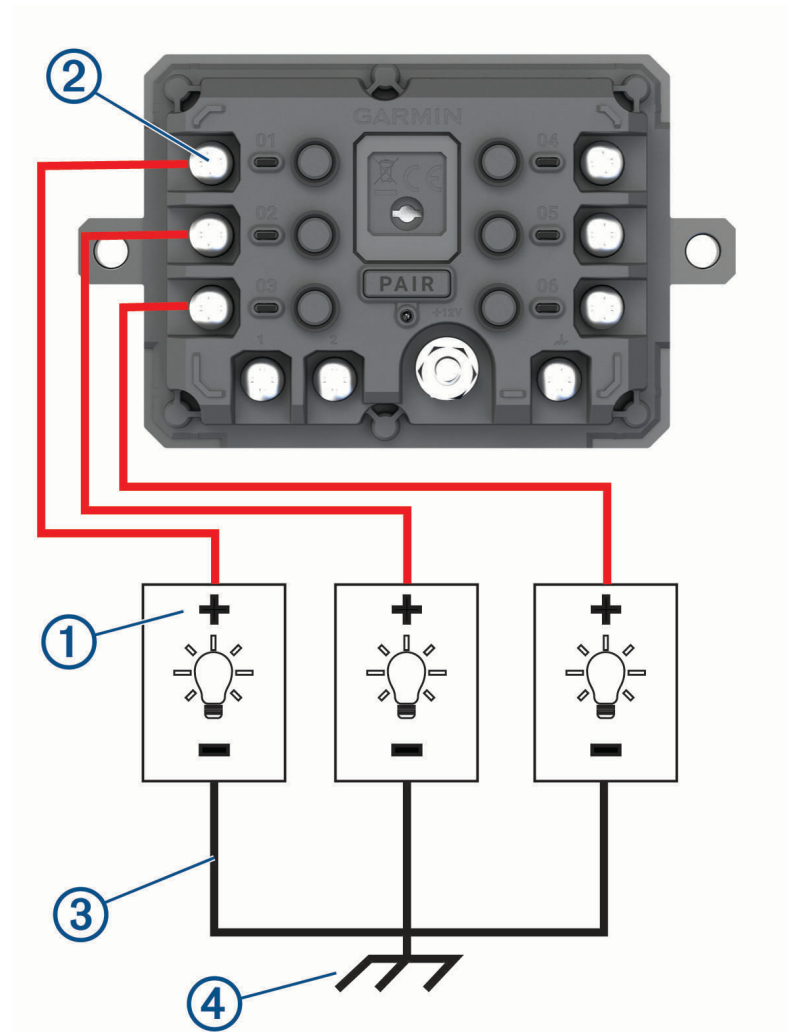

- 2 Connect the negative or ground wire ③ to an unpainted ground stud ④ on the vehicle frame, to a ground distribution block, or directly to the negative terminal on the battery.

NOTICE

Do not connect the accessory ground wires to the ground terminal (GND) on the Garmin PowerSwitch device. Failure to heed this notice could result in personal or property damage, or negatively impact device functionality.

3 Verify that all electrical connections are tight and will not come loose during use.

Connecting a Control Input

You can connect to the control terminals to enable the Garmin PowerSwitch device to turn on customizable outputs. For example, you can connect your vehicle ignition switch to a control input terminal to turn on accessories automatically each time you start your vehicle. The control terminals detect a signal from 3.3 V to 18 V. You can configure output functions with the Garmin PowerSwitch app.

Connect the control wire from the control source in your vehicle to one of the two control terminals on the Garmin PowerSwitch device.

Connecting the Device to Vehicle Power

Before you can connect the device to vehicle power, you must remove the warning tag from the +12V terminal on the device.

You should always confirm all electrical connections are secure and will not come loose while operating the device.

1 Connect the large ring end of the included ground wire ① to the negative terminal on the vehicle battery.

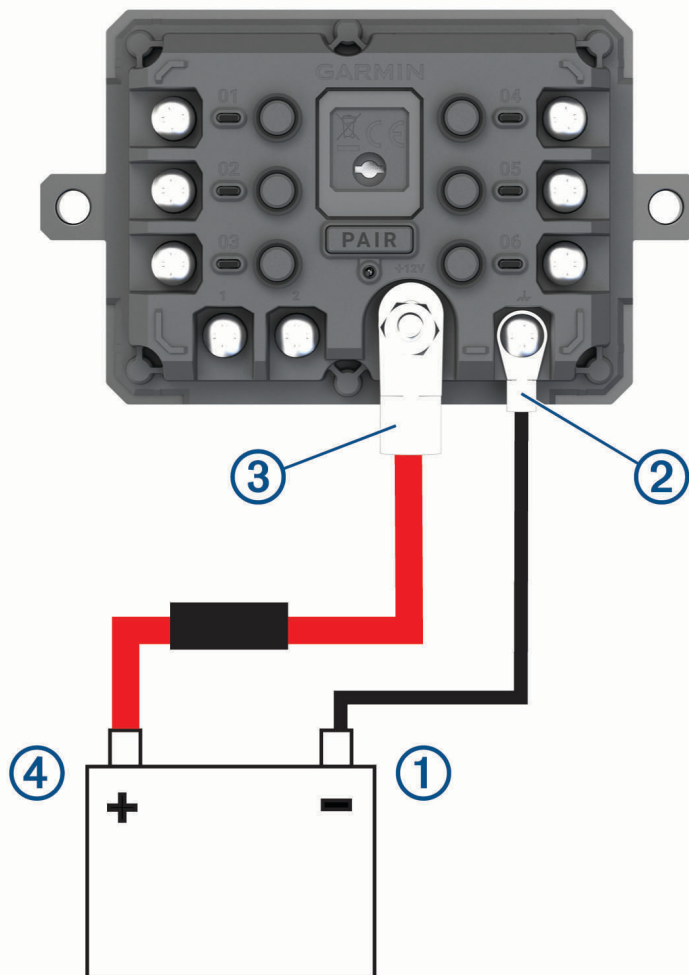

2 Connect the small ring end of the ground wire to the **GND** terminal ② on the device.

3 Connect the small ring end of the included 12V cable to the **+12V** terminal ③ on the device.

- 4 Tighten the $\frac{3}{8}$ in. nut on the +12V terminal to a maximum torque specification of 4.52 N-m (40 lbf-in.). You should confirm the nut cannot be loosened by hand.

NOTICE

Do not overtighten the +12V terminal to prevent damage to the terminal.

- 5 Connect the large ring end of the 12V cable  to the positive terminal on the vehicle battery.

Pairing with a Garmin Navigation Device

You can pair your Garmin PowerSwitch device with a compatible Garmin navigation device.

- 1 Turn on power to your Garmin PowerSwitch device, and place your compatible Garmin navigation device within 1 m (3.3 ft.) of it.
- 2 On your compatible navigation device, open the Garmin PowerSwitch app.
- 3 Follow the on-screen instructions to complete the pairing and setup process.

The main app dashboard appears. After the devices are paired, they connect automatically when they are turned on and within range.

Garmin PowerSwitch Specifications

Dimensions (D x W x H)	75 x 125 x 32 mm (2.95 x 4.92 x 1.26 in.)
Operating temperature range	From -25° to 85°C (from -13° to 185°F)
Wireless frequency	2.4 GHz @ 10 dBm
Power input	From 12 to 16 V using the included vehicle power cable.
Maximum accessory output	30 A
Maximum system output	100 A
Current draw with all outputs off	3 mA
Water rating	IEC 60529 IPX7 ²

Garmin PowerSwitch Troubleshooting

My Garmin PowerSwitch will not stay connected

- Verify the Garmin PowerSwitch device is receiving power.
- Verify that Bluetooth technology is enabled on your paired navigation device or smartphone.
- Move the navigation device or smartphone closer to your Garmin PowerSwitch device.
- Verify that your vehicle's battery is supplying at least 12 V of power.

The Garmin PowerSwitch device turns off all outputs automatically to preserve your vehicle's battery if it is receiving less than 11 V of power (*My accessories are not receiving power*, page 63).

² The device withstands incidental exposure to water of up to 1 m for up to 30 min. For more information, go to www.garmin.com/waterrating.

My accessories are not receiving power

- Verify the Garmin PowerSwitch device is receiving power from the vehicle battery.
- Verify that your vehicle's battery is supplying at least 12 V of power.
The Garmin PowerSwitch device turns off all outputs automatically to preserve your vehicle's battery if it is receiving less than 11 V of power. Outputs turn back on when the device detects more than 12 V of power.
- Verify that all electrical connections are secure and will not come loose while operating the vehicle.
- Verify that each connected accessory draws less than 30 A.
If an accessory draws more than 30 A, the device turns off that output automatically.
- Verify that the total system load is less than 100 A.
If the device detects a system load of more than 100 A, it turns off all outputs automatically.
- Inspect all electrical connections for an electrical short circuit.

Tread Audio

WARNING

Garmin strongly recommends having an experienced installer with the proper knowledge of electrical systems install the device. Incorrectly wiring the power cable can result in damage to the vehicle or the battery and can cause bodily injury.

You can use a connected Tread Audio system to control audio and LED lights from your Tread XL device.

Tools and Materials Needed

- Phillips screwdriver
- Electric drill
- Drill bit (the size varies based on the surface material and screws used)
- Crimping pliers
- Wire strippers
- Heat gun
- 4 mm and 5 mm hex drivers or hex keys

NOTE: For customized installations, additional tools and materials may be needed.

Tread Audio Box Mounting Considerations

CAUTION

In high ambient temperatures and after extended use, the device enclosure may reach temperatures deemed dangerous to touch. Therefore, you must install the device in a location where it is not touched during operation.

NOTICE

The storage and operating temperature ranges for this device are listed in the product specifications. Extended exposure to temperatures exceeding the specified temperature range, in storage or operating conditions, may cause device failure. Device damage and related consequences caused by extended exposure to these conditions are not covered by the warranty.

- You must mount the device in a location with adequate ventilation where it is not exposed to extreme temperatures.
- You should mount the device so that the cables can be connected easily.
- To achieve IP67 water ingress protection and optimal heat sink cooling, you must mount the device on a vertical surface with the connectors pointing downward.
- You can mount the device on a horizontal surface, but such positioning might not achieve IPX67 water ingress protection.
- To avoid interference with a magnetic compass, you should install the device at least 203 mm (8 in.) away from a compass.

Mounting the Tread Audio Box Black Box Device

Before you mount the device, you must select a mounting location, and determine what screws and other mounting hardware are needed for the surface.

- 1 Place the black box device in the mounting location, and mark the location of the pilot holes.
- 2 Drill a pilot hole for one corner of the device.
- 3 Loosely fasten the device to the mounting surface with one corner, and examine the other three pilot-hole marks.
- 4 Mark new pilot-hole locations if necessary, and remove the device from the mounting surface.
- 5 Drill the remaining pilot holes.
- 6 Secure the device to the mounting location.

Connections

The stereo must be connected to power, to speakers, and to media input sources to function correctly. You should carefully plan the layout of the stereo, speakers, and your input sources before making any connections.

Port Identification

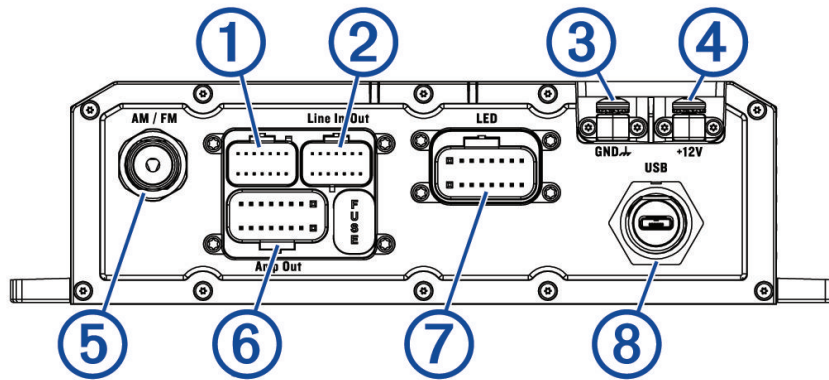

Item	Description
FUSE	Contains the 15 A fuse for the LED outputs.
①	Not used.
②	Connects the device to the auxiliary in and line/subwoofer out wiring harness.
③	Connects the device to the ground terminal wire (GND).
④	Connects the device to the +12V terminal wire.
⑤	Connects the device to the AM/FM antenna.
⑥	Connects the device to the speaker wiring harness.
⑦	Connects the device to the LED wiring harness.
⑧	Connects the device to an optional USB accessory.

Speaker and LED Wiring Harness Wire and Connector Identification

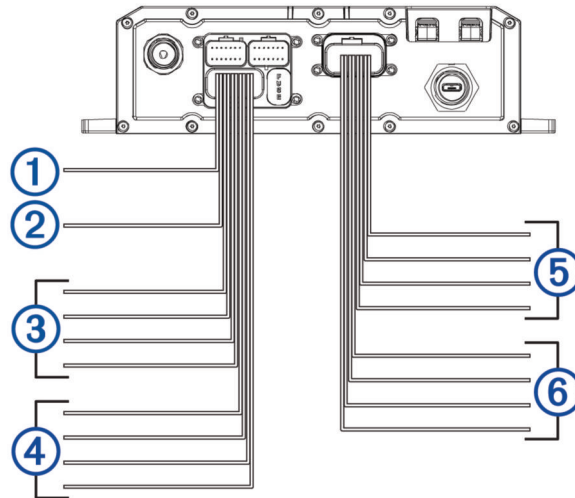

Wire Group	Wire Color and Description
① Ignition	Red: Connects to the vehicle accessory line. If the ignition wire is unused, ground the ignition wire or leave it disconnected.
② Amplifier on	Blue: Connects to an optional external amplifier to turn it on when the stereo turns on.
③ Speaker zone 1	White: Left (+), Connects to the included speaker. White with a black stripe: Left (-), Connects to the included speaker. Gray: Right (+), Connects to the included speaker. Gray with a black stripe: Right (-), Connects to the included speaker.
④ Speaker zone 2	Green: Left (+), Connects to an additional speaker. Green with a black stripe: Left (-), Connects to an additional speaker. Purple: Right (+), Connects to an additional speaker. Purple with a black stripe: Right (-), Connects to an additional speaker.
⑤ LED RGB1	Black: Power Red: Red LED Green: Green LED Blue: Blue LED
⑥ LED RGB2	Black: Power Red: Red LED Green: Green LED Blue: Blue LED

Addressable LED Wiring Considerations

You can wire addressable LED lights to your Tread Audio Box. For more information, see the manual for your addressable LED lights.

Compatible addressable LED types:

- WS2812B
- WS2813

Addressable LED	LED Wire Color and Function
Addressable LED 1	Red: +5V Power White: Ground Green with a black stripe: Data
Addressable LED 2	Red: +5V Power White: Ground Green with a black stripe: Data

RCA Wiring Harness Wire and Connector Identification

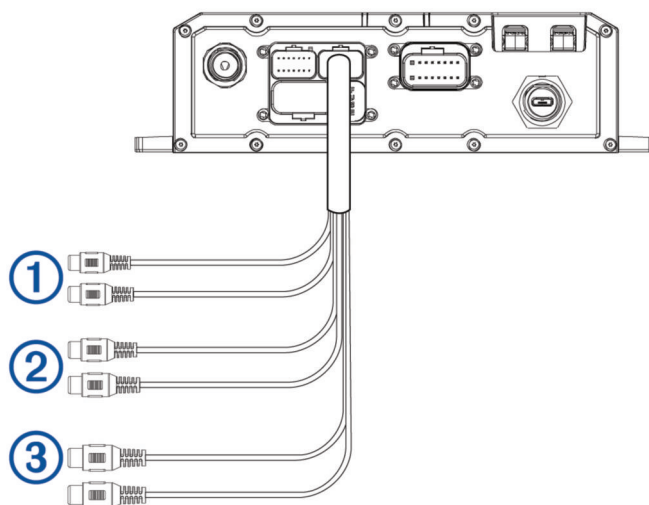

Wire Number	Wire Function
①	Auxiliary in left: Provides a red and white RCA stereo line input for audio sources, such as a CD or MP3 player. Auxiliary in right: Provides a red and white RCA stereo line input for audio sources, such as a CD or MP3 player.
②	Line out left: Provides a full-range output to an external amplifier, and is associated with the volume control. Line out right: Provides a full-range output to an external amplifier, and is associated with the volume control. NOTE: If you are connecting to an external amplifier, you should use a ground loop isolator to ensure a clear signal.
③	Subwoofer out: Provides a single mono output to a powered subwoofer or subwoofer amplifier. NOTE: If you are connecting to an external amplifier, you should use a ground loop isolator to ensure a clear signal.

Connecting the Device to Vehicle Power

You should always confirm all electrical connections are secure and will not come loose while operating the device.

NOTICE

If the ignition wire is not used, do not tie the ignition to the positive terminal on the vehicle battery. Ground the ignition wire or leave it disconnected. Failure to ground or disconnect the ignition wire when the ignition is not used could prevent the device from powering on.

- 1 Remove the terminal cover ① using a Phillips screwdriver.

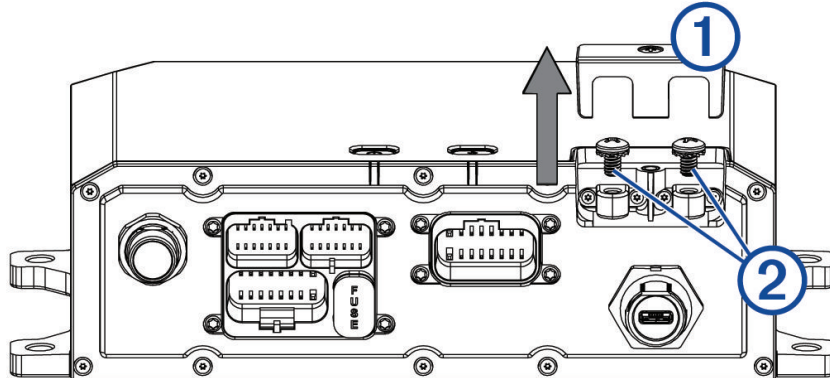

- 2 Remove the screws from the **GND** terminal and the **+12V** terminal ②.
- 3 Connect the large ring end of the included ground wire ③ to the negative terminal on the vehicle battery.

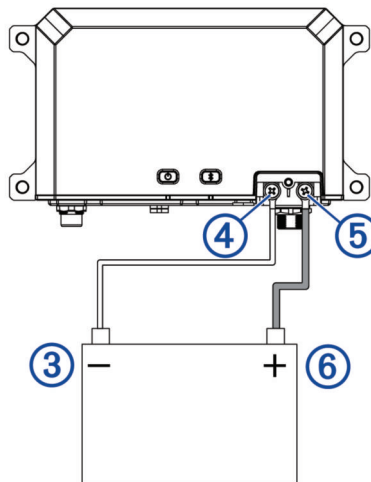

- 4 Connect the small ring end of the ground wire to the **GND** terminal ④ on the device.
- 5 Tighten the screw on the GND terminal.
You should confirm the screws cannot be loosened by hand.
- 6 Connect the small ring end of the included 12V cable to the **+12V** terminal ⑤ on the device.
- 7 Tighten the screw on the +12V terminal.
You should confirm the screws cannot be loosened by hand.

NOTICE

Do not overtighten the screw on the +12V terminal to prevent damage to the terminal.

- 8 Connect the large ring end of the 12V cable ⑥ to the positive terminal on the vehicle battery.
- 9 Replace and tighten the terminal cover on the device.

Using the Heat-Shrink Crimp Connectors

You should use the included heat-shrink crimp connectors to make a water-tight connection between the bare wires.

⚠ WARNING

Only use the heat gun to apply heat to the heat-shrink crimp connectors in a well-ventilated area. Do not use the heat gun near clothing or bare skin. Doing so can result in property damage or serious injury.

- 1 Using wire strippers, strip 6 mm ($\frac{1}{4}$ in.) off the end of each bare wire.
- 2 If necessary, twist the strands of each wire ① clockwise to bundle them together.

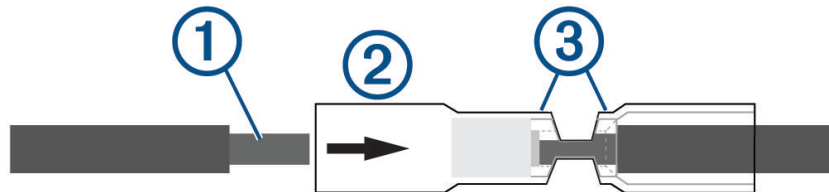

- 3 Insert one bare wire into one end of the heat-shrink crimp connector ②.
The bare wires are not secure until they are crimped and sealed.
- 4 Insert the corresponding bare wire into the other end of the heat-shrink crimp connector.
- 5 Using pliers, crimp both sides of the center of the connector ③ to secure the connection.
- 6 Using a heat gun, apply heat to the heat-shrink crimp connector until the connector is sealed to the wires.
Do not apply heat to the wires directly.

Complete System Wiring

This diagram illustrates a system installation with an external amplifier and subwoofer connected to the stereo using a line out.

NOTE: You can also connect speakers to the speaker wires for the internal stereo amplifier while using an external amplifier connected to the line out. Adjusting the volume affects speakers connected to the internal amplifier and speakers connected to the line out. This may result in uneven volume levels.

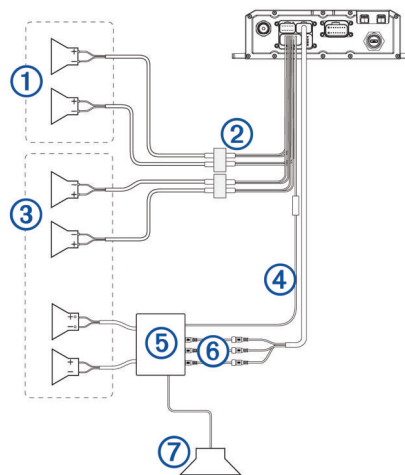

Item	Description
①	Zone 2 speakers
②	Water-tight connection
③	Zone 1 speakers
④	Amplifier-on signal wire
⑤	Powered amplifier
⑥	Line out and subwoofer out
⑦	Subwoofer

Speaker Zones

You can group speakers in one area into speaker zones. This enables you to control the audio level of the each zone individually.

Zones 1 and 2 are powered by the on-board amplifier. To use the RCA line output, you must connect an external amplifier.

You can set the balance, tone, and name for each zone, and the fade between zones.

Single-Zone System Wiring Example

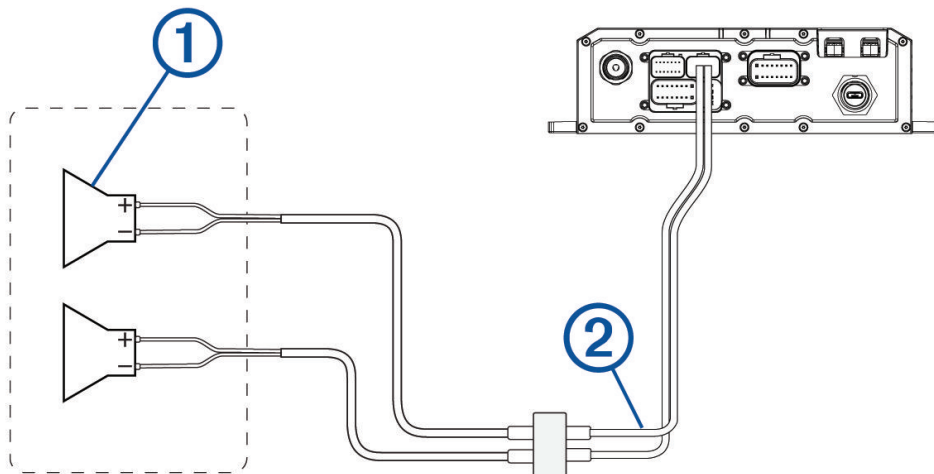

①	Speakers
②	Water-tight connection

Wireless Remote Mounting Considerations

NOTICE

Selecting the correct mounting location is critical to optimize the performance of the wireless remote.

- You must mount the wireless remote in a location that is within 10 m (33 ft.) of the stereo.
- You must mount the wireless remote in a location where it is not submerged.
- You should select a flat mounting surface for the best results.
- The mounting surface must be free of dirt, debris, wax, or coatings.
- Move away from sources that can interfere with the wireless remote's operation. Sources of interference may include strong electromagnetic fields, some 2.4 GHz wireless sensors, high-voltage power lines, electric motors, and wireless LAN access points.
- You should install the wireless remote in a location where you can allow the adhesive to dry at room temperature for 72 hours.

Mounting the Wireless Remote

- 1 Select an appropriate location for the remote control (*Wireless Remote Mounting Considerations, page 70*).
- 2 Test the range at the selected location by holding the wireless remote at the location, pressing a few buttons, and confirming the correct operation.
- 3 Thoroughly clean and dry the mounting surface using a mixture of water and isopropyl alcohol.
The mounting surface must be free of dirt, debris, wax, or coatings.
- 4 Place the wireless remote on the mount, and rotate the remote until you hear a click.
- 5 Remove the backing from the adhesive.
- 6 Carefully orient the wireless remote in the mount with the Fusion® logo at the bottom.

NOTICE

It is extremely difficult to remove the adhesive. Some mounting surfaces might be damaged after removing the adhesive.

- 7 Press the wireless remote in the mount firmly onto the mounting surface, maintaining pressure for at least 60 seconds.

Mounting the Speakers and Brackets

You can mount the Tread 6.5" XS-LED Tower Speakers to a roll bar using the included brackets.

When installing the speaker and bracket, you can route the speaker and LED cable along the roll bar.

- 1 If necessary, mark the locations on the roll bar where you plan to mount the speakers.
- 2 Route the speaker and LED power wires along the roll bar to the mounting locations.
- 3 Feed the cable ① from the speaker through the base of the bracket ②.

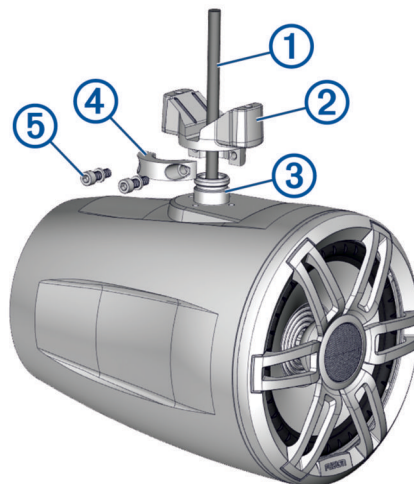

- 4 Place the base of the bracket over the mounting knob on the speaker ③.
- 5 Using a 4 mm hex driver or hex key, attach the collar ④ to the base of the bracket using the two shorter screws and washers ⑤, but do not fully tighten them.
- 6 Connect the speaker and LED wires ([Wiring](#), page 72).
- 7 Place the connected wires in the channel on the base of the bracket ⑥, and route the wires along the roll bar.

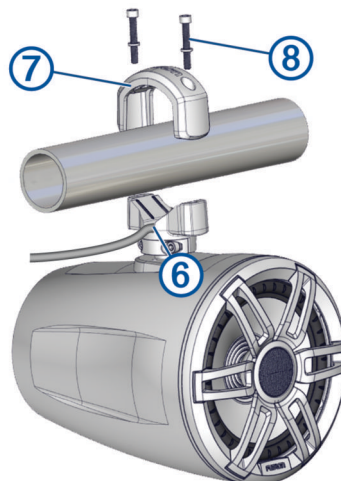

- 8 Place the top of the bracket ⑦ over the roll bar, and hold it against the base of the bracket.
- 9 Using a 5 mm hex driver or hex key, attach the top of the bracket to the base of the bracket using the two longer screws and washers ⑧, but do not fully tighten them.

10 Adjust the angle of the speakers, and tighten all of the screws to secure the speaker to the roll bar, observing these maximum torque measurements:

- For the longer screws that secure the bracket to the roll bar ⑧, do not tighten to more than 4 N-m (2.95 lbf-ft.).
- For the shorter screws that secure the bracket to the speaker ⑤, do not tighten to more than 2.5 N-m (1.84 lbf-ft.).

NOTICE

Tightening the screws more than the specified maximum torque measurement can damage the bracket.

11 Repeat these steps for additional brackets.

12 Route the speaker and LED wires along a suitable path in your vehicle, and secure them using the included zip ties.

Wiring

When connecting the speakers and LED lights to your stereo or amplifier, observe these considerations.

- You should use the included wire to connect the speakers to the stereo or amplifier. If necessary, you can use a larger gauge of wire (*Wire Gauge Guide, page 72*).
- You should make all of the wiring connections using the included heat-shrink crimp connectors. You should plan and select the best connection type for your installation needs.
- You can use this table to identify the polarity of the leads on the speaker.

Lead color	Polarity	Use
White	Positive (+)	Speaker
White with a black stripe	Negative (-)	Speaker
Red		Red LED
Green		Green LED
Blue		Blue LED
Black		+12V Power

Wire Gauge Guide

If necessary, you can use longer cables for your installation.

NOTE: If you are using aluminum or tinned wire, you should use a wire two gauges larger than the gauge listed below to compensate for a potential voltage drop due to the wire material.

- Use 16 AWG (1.31 mm²) for speaker wires.
- Use 20 AWG (0.52 mm²) for LED wires.

Additional Speakers







You can wire additional Tread 6.5" XS-LED Tower Speakers together. Refer to the owner's manual for your stereo system at garmin.com/express for more information.

Wireless Remote Overview

⚠ WARNING

See the *Important Safety and Product Information* guide in the product box for product warnings and other important information.



	Radio sources: Press to tune to the previous station. AUX sources: Press to decrease gain. Other sources: Press to skip to the beginning of the track or to the previous track.
	Radio sources: Press to tune to the next station. AUX sources: Press to increase gain. Other sources: Press to skip to the next track.
	Press to decrease the volume. Hold to quickly decrease the volume.
	Press to increase the volume. Hold to quickly increase the volume.
	Press to cycle through the available sources. Hold to pair with a stereo (Connecting the Wireless Remote to your Tread Audio Box, page 73).
	Radio and AUX sources: Press to mute or un-mute. Other sources: Press to pause or resume.

Connecting the Wireless Remote to your Tread Audio Box

- 1 Bring the Tread Audio System remote within 10 m (33 ft.) of the compatible stereo.
NOTE: Stay 10 m (33 ft.) away from other ANT[®] devices while pairing.
 - 2 On the Tread Audio Box, enable Bluetooth discoverable mode.
 - 3 On the wireless remote, hold  until the status LED flashes green and red.
The remote searches for the stereo. When the remote pairs successfully, the status LED flashes green briefly and turns off.
- If the remote cannot find the stereo, the status LED flashes red briefly and turns off.

Pairing with a Garmin Navigation Device

You can pair your Tread Audio device with a compatible Garmin navigation device.

- 1 Update your compatible navigation device to the latest software.
Your navigation device may not support the Tread Audio device without the latest software. For more information about updating the device software, see the owner's manual for your navigation device.
- 2 Turn on power to your Tread Audio device, and place your compatible Garmin navigation device within 1 m (3.3 ft.) of it.
- 3 On your compatible navigation device, open the Tread Audio app.
- 4 On your Tread Audio device, press .
- 5 Follow the on-screen instructions to complete the pairing and setup process.

The main app dashboard appears. After the devices are paired, they connect automatically when they are turned on and within range.

Tread Audio Box Specifications

General	
Weight	997 g (2.2 lbs.)
Water resistance	IEC 60529 IPX7 (water), IEC 60529 IP6X (dust) ³
Operating temperature range	From -20 to 70°C (from -4 to 158°F)
Storage temperature range	From -40 to 85°C (from -40 to 185°F)
Input voltage	From 8 to 14.4 Vdc
Current (max.)	40 A
Current (muted)	less than 650 mA
ANT wireless range	Up to 3 m (10 ft.)
Compass-safe distance	203 mm (8 in.)
Fuse	15 A mini-blade type
Bluetooth wireless range	Up to 10 m (30 ft.)

On-board, Class D Amplifier	
Output power per channel	4 x 100 W RMS at 14.4 Vdc input, 4 ohm, 10% THD ⁴
Line output level (max.)	6.0 V (peak to peak)
Aux input level (typical)	1 V (RMS)

Tuner	
FM radio frequency range	87.5 to 107.9 MHz
FM frequency step	200 kHz
AM radio frequency range	530 to 1710 kHz
AM frequency step	10 kHz

³ The device withstands incidental exposure to water of up to 1 m for up to 30 min, and is protected against powerful jets of water. For more information, go to www.garmin.com/waterrating.

⁴ The stereo may limit the output power to prevent the amplifier from overheating, and to maintain the audio dynamics.

Tread 6.5" XS-LED Tower Speakers Specifications

Max. power	200 W
RMS power	50 W
Sensitivity (1 W/1 m)	91 dB
Frequency response	From 80 Hz to 18 kHz
Recommended amplifier power (RMS, playing music)	From 20 to 150 W
Nominal voice coil diameter	30 mm
Impedance	4 ohms
Operating temperature range	From 0 to 50°C (from 32 to 122°F)
Storage temperature range	From -20 to 70°C (from -4 to 158°F)
Cone material	Polypropylene (PP) cone with cloth surround
Tweeter type	Aluminum dome
Water and dust rating	IEC 60529 IP67 ⁵
Compass-safe distance	310 cm (122 in.)
Weight	2.49 kg. (5.5 lb.)

Dimensions

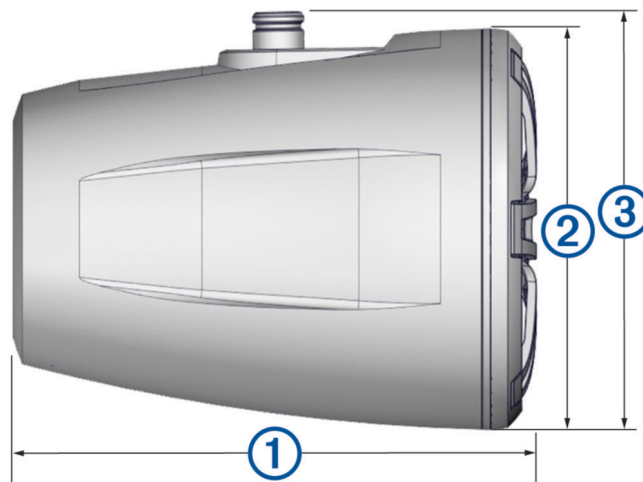

①	223 mm (8 ¹³ / ₁₆ in.)
②	Ø 176 mm (6 ¹⁵ / ₁₆ in.)
③	180 mm (7 ¹ / ₈ in.)

⁵ Protected against dust and water ingress.

Bracket Specifications

Material	Aluminum alloy with silicone pads
Supported roll bar sizes	From 33.4 mm (1.31 in.) to 50.8 mm (2.00 in.) outer diameter

Bracket Side Dimensions

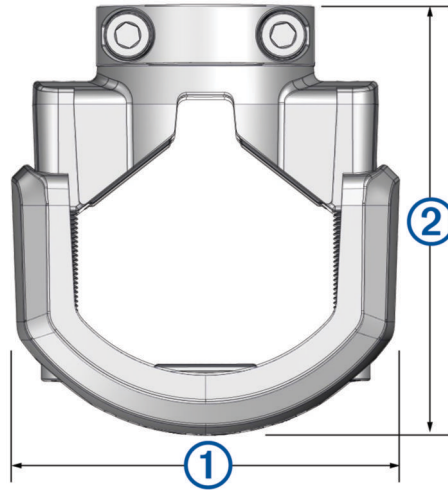

①	85 mm (3 ³ / ₈ in.)
②	From 74 mm (2 ⁷ / ₈ in.) to 94 mm (3 ¹¹ / ₁₆ in.)

Bracket Top Dimensions



①	37 mm (1 ⁷ / ₁₆ in.)
②	48 mm (2 in.)

Data Management

The device has a memory card slot for additional data storage.

NOTE: The device is compatible with Windows® 7 and newer, and Mac® OS 10.7 and newer. Apple® computers may require additional third-party software to read and write files.

About Memory Cards

You can purchase memory cards from an electronics supplier, or purchase pre-loaded Garmin mapping software (www.garmin.com). Memory cards can be used to store files such as maps and POIs.

Installing a Memory Card for Maps and Data

You can install a memory card to increase the storage space for maps and other data on your device. You can purchase memory cards from an electronics supplier. The device supports microSD memory cards from 4 to 256 GB. Memory cards must use the FAT32 file system format. Memory cards greater than 32 GB must be formatted using the device ([Formatting the Memory Card, page 77](#)).



- 1 Locate the map and data memory card slot on your device ([Device Overview, page 1](#)).
- 2 Insert a memory card into the slot.
- 3 Press it in until it clicks.

Formatting the Memory Card

The device requires a memory card formatted using the FAT32 file system. You can use the device to format your card using this file system.

You must format a brand new memory card if it is not formatted using the FAT32 file system.

NOTE: Formatting the memory card deletes all data on the card.

- 1 Select  > **Tools** >  > **Device** > **Storage & USB**.
- 2 Select your memory card.
- 3 Select  > **Storage settings** > **Format** > **FORMAT SD CARD**.
- 4 Select **Done**.

Connecting the Device to Your Computer

You can connect the device to your computer using a USB cable.

- 1 Plug the small end of the USB cable into the port on the device.
- 2 Plug the larger end of the USB cable into a port on your computer.

Depending on your computer operating system, the device appears as either a portable device, a removable drive, or a removable volume.

Transferring GPX Files From Your Computer

Apple computers may require additional third-party software, such as Android File Transfer, to read and write files on this device.

If you have already created routes that you want to use on your device, you can transfer GPX files directly from your computer.

- 1 Connect the device to your computer ([Connecting the Device to Your Computer, page 77](#)).
The device appears as a portable device.
- 2 On your computer, open the file browser.
- 3 Select a GPX file.
- 4 Select **Edit** > **Copy**.
- 5 Browse to the GPX folder on the device.
- 6 Select **Edit** > **Paste**.

Transferring Data From Your Computer

- 1 Connect the device to your computer ([Connecting the Device to Your Computer, page 77](#)).

Depending on your computer operating system, the device appears as either a portable device, a removable drive, or a removable volume.

- 2 On your computer, open the file browser.
- 3 Select a file.
- 4 Select **Edit > Copy**.
- 5 Browse to a folder on the device.

NOTE: For a removable drive or volume, you should not place files in the Garmin folder.

- 6 Select **Edit > Paste**.

Disconnecting the USB Cable

If your device is connected to your computer as a removable drive or volume, you must safely disconnect your device from your computer to avoid data loss. If your device is connected to your Windows computer as a portable device, it is not necessary to safely disconnect the device.

- 1 Complete an action:
 - For Windows computers, select the **Safely Remove Hardware** icon in the system tray, and select your device.
 - For Apple computers, select the device, and select **File > Eject**.
- 2 Disconnect the cable from your computer.

Adding BaseCamp™ Data to Garmin Explore

You can export your BaseCamp data files and import them to Garmin Explore for use with your Tread XL device.

- 1 Export your data from BaseCamp:
 - If you are using an Apple computer, see [Exporting Data from BaseCamp with an Apple Computer, page 78](#).
 - If you are using a PC, see [Exporting Data from BaseCamp with a PC, page 78](#).
- 2 Import your BaseCamp data to the Garmin Explore website ([Importing Data to Garmin Explore, page 79](#)).
- 3 Synchronize your Garmin Explore data with your Tread XL device.

Exporting Data from BaseCamp with a PC

- 1 Select an option:
 - To export all BaseCamp data stored on your computer, select **My Collection**, and select **File > Export > Export 'My Collection'**.
 - To export one or more items or a list, select one or more items or a list, and select **File > Export > Export Selection**.
- 2 Enter a name, select a location for the exported file, select the file format, and select **Save**.

Exporting Data from BaseCamp with an Apple Computer

- 1 Select an option:
 - To export all BaseCamp data stored on your computer, select **My Collection**, and select **File > Export 'My Collection'**.
 - To export one or more items or a list, select one or more items or a list, and select **File > Export Selected User Data**.
- 2 Enter a name.
- 3 Select a location for the exported file.
- 4 Select the file format.
- 5 Select **Export**.

Importing Data to Garmin Explore

- 1 Go to explore.garmin.com and log in to your account.
- 2 Select the **Map** tab.
- 3 Select .
- 4 Follow the on-screen instructions.

Purchasing Additional Maps

- 1 Go to your device product page at garmin.com.
- 2 Click the **Maps** tab.
- 3 Follow the on-screen instructions.

