

Xero™ A1/A1i

Owner's Manual

© 2018 Garmin Ltd. or its subsidiaries

All rights reserved. Under the copyright laws, this manual may not be copied, in whole or in part, without the written consent of Garmin. Garmin reserves the right to change or improve its products and to make changes in the content of this manual without obligation to notify any person or organization of such changes or improvements. Go to www.garmin.com for current updates and supplemental information concerning the use of this product.

Garmin®, the Garmin logo, and ANT® are trademarks of Garmin Ltd. or its subsidiaries, registered in the USA and other countries. Garmin Express™, Laser Locate™, and Xero™ are trademarks of Garmin Ltd. or its subsidiaries. These trademarks may not be used without the express permission of Garmin.

Mac® is a trademark of Apple Inc, registered in the U.S. and other countries. Windows® is a registered trademarks of Microsoft Corporation in the United States and other countries. Other trademarks and trade names are those of their respective owners.

Table of Contents

Getting Started	1
Video Tutorials.....	1
Device Overview.....	1
Buttons.....	1
Installing AAA Batteries.....	1
Mounting the Sight on a Bow.....	1
Securing the Trigger.....	2
Turning the Device On or Off.....	2
Calibrating the Bow Sight	2
Torque Specifications.....	2
Setting the Primary Pin.....	2
Aligning the Rangefinder with the Primary Pin.....	3
Adjusting the Bubble Level.....	4
Using the Bow Sight	4
Rangefinder Measurements.....	4
Setting a Manual Range.....	4
Level Indicator.....	4
Main Menu.....	4
Hunt Mode.....	4
Practice Mode.....	4
Statistics Mode.....	4
Recording Statistics.....	5
Viewing Statistics History.....	5
Clearing Stats Mode History.....	5
Adjusting Brightness.....	5
Adding Arrow Profiles.....	5
Managing Arrow Profiles.....	5
Pin Calibration.....	5
Calibrating Additional Ranges.....	5
Fixed Pins.....	5
Laser Locations.....	6
Sending Locations to a Device.....	6
Viewing Shot Dynamics.....	6
Shot Dynamics.....	6
Device Settings	6
Pin Settings.....	6
Laser Location Settings.....	6
Shot Dynamics Settings.....	6
Units Settings.....	7
Level Settings.....	7
Calibrating the Compass.....	7
Customizing the Position of the Top Pin.....	7
Moving the Calibrated Range Stack.....	7
Device Information	7
Device Specifications.....	7
Viewing E-label Regulatory and Compliance Information.....	7
Product Updates.....	7
Updating the Software Using a Computer.....	7
Connecting the Device to Your Computer.....	8
Device Care.....	8
Cleaning the Device.....	8
Getting More Information.....	8
Troubleshooting.....	8
The point of impact moves between shots.....	8
My device only displays fixed pins.....	8
Tips for Consistent Ranging.....	8
Resetting the Device.....	8
Index	9

Getting Started

⚠ WARNING

Always inspect your equipment prior to shooting an arrow. Always understand your target and what lies beyond your target before taking a shot. Failure to account for your shooting environment could cause property damage, injury, or death. You are responsible for understanding and complying with any applicable regulations for shooting a bow and arrow.

This device has a protective housing which, when in place, prevents human access to laser radiation in excess of the accessible emission limit (AEL) for Class 1 laser products. This device should not be modified or operated without its housing or optics. Operating this device without a housing and optics, or operating this device with a modified housing or optics that expose the laser source, may result in direct exposure to laser radiation and the risk of permanent eye damage. Removal or modification of the diffuser in front of the laser optic may result in the risk of permanent eye damage.

See the *Important Safety and Product Information* guide in the product box for product warnings and other important information.

Video Tutorials

You can view video tutorials for installing and setting up your Xero bow sight at www.garmin.com/xerotutorials.

Device Overview



① LCD screen	Displays target range and device settings
② Buttons	Select to move through menus, select options, and configure the device (Buttons , page 1)
③ Laser rangefinder trigger	Hold to activate the laser rangefinder Tap to reset the pin timer or display fixed pins
④ Mounting rail	Attaches the device to the included mount
⑤ Level	Shows when the device is level
⑥ Optic	Displays the pins
⑦ Battery door	Remove to install batteries
⑧ Laser receiver	Receives laser light for measuring the distance to a target

⑨ Laser emitter	Emits laser light for measuring the distance to a target
⑩ Device label	View manufacturer's identification and certification <div style="border: 1px solid black; padding: 5px; text-align: center;"> <p>Garmin International 1200 E. 151st St. Olathe, KS 66062 www.garmin.com</p> <p>CLASS 1 LASER PRODUCT CLASSIFIED EN/IEC 60825-1 2014 This product is in conformity with performance standards for laser products under 21 CFR 1040, except with respect to those characteristics authorized by Variance Number FDA-2016-V-2943 effective March 21, 2018</p> </div>

Buttons

- Press **OK** to open the main menu and select menu options.
- Press **<** or **>** to move through menus.
- Press **<** or **>** to adjust the pin brightness.
- Hold **<** or **>** to set a pin manually.
- Press **↶** to return to a previous menu.
- Press **↷** to turn the device on.
- Hold **↷** to turn the device off.

Installing AAA Batteries

The device operates on two AAA lithium batteries (not included). Lithium batteries are required for this device. Alkaline and NiMH batteries do not meet the power requirements for auto-ranging functionality. When using alkaline or NiMH batteries, the sight functionality may be reduced to standard fixed pin sighting only.

- 1 Using a 5/64 inch hex wrench, loosen the four screws ①, and remove the battery door ② from the side of the device.



- 2 Insert two AAA lithium batteries into the device, observing polarity.
- 3 Replace the battery cover, and secure the screws to a maximum torque specification of 0.5 N-m (4 lbf-in).

Mounting the Sight on a Bow

- 1 Insert the curved rail mount ① from the back of the bow sight into the grooves at the front of the mount assembly ②.

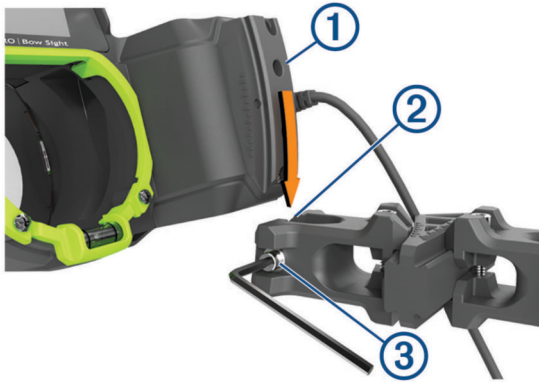



- 2 Align the arrow on the mount with the center arrow on the curved rail.
- 3 Using a 7/64 inch hex wrench, tighten the screw at the front of the rail mount ③ to a maximum torque specification of 2.2 N-m (20 lbf-in).
- 4 Align the large holes on the mount ④ with the mounting holes on the side of your bow.



- 2 Secure the trigger to the bow using the included tape ②.
TIP: You can use the extra piece of tape to secure the trigger cable to the riser.

Turning the Device On or Off

- 1 To turn on the device, press .
- 2 To turn off the device, hold  for 3 sec.



TIP: The mount contains three sets of mounting holes. Mount the sight in a location that functions best with your peep sight aperture. Mounting the sight closer to the bow may allow a better fit in some bow cases.

- 5 Using a 1/8 inch hex wrench, secure the mount using the included mounting screws ⑤.
- 6 Tighten the mounting screws to a maximum torque specification of 6.7 N-m (60 lbf-in).
NOTE: Do not exceed the bow manufacturer's recommended torque values.

Securing the Trigger

- 1 Position the ranging trigger ① on the grip of your bow where you can comfortably activate it at full draw.

NOTE: You should confirm the trigger and the trigger cable are positioned so they do not interfere with the operation of the bow.

Calibrating the Bow Sight

The first time you turn on the Xero bow sight, you are prompted to go through initial setup steps. You can view tutorial videos at www.garmin.com/xerotutorials.

- 1 Select a language.
- 2 Select a unit of measure.
- 3 Select **Yes** to start the pin calibration procedure.
- 4 Select a ranged pin color (A1i model only).
- 5 If necessary, select **Yes** to adjust the pin and rangefinder reticle brightness and follow the on-screen instructions.
- 6 Set the primary pin (*Setting the Primary Pin, page 2*).
- 7 Select **Done**.
- 8 Align the rangefinder with the primary pin (*Aligning the Rangefinder with the Primary Pin, page 3*).
- 9 Select **Done**.
- 10 Follow the on-screen instructions to complete the pin calibration procedure and set pins for additional distances.

Torque Specifications

When adjusting and tightening the mounting screws, you should ensure the screws are always tightened to a maximum torque specification of 2.2 N-m (20 lbf-in.). If you do not have a torque wrench, you can tighten the screws until the screw head makes contact with the mount surface, then tighten the screw an additional one quarter turn.

Setting the Primary Pin

The primary pin is a fixed point on the device optic that points along the same axis as the laser rangefinder. You can change the primary pin's alignment by adjusting the straight vertical and horizontal adjustments on the mount. After you set the primary pin, you can set additional pins for different distances using the device software.

- 1 Aim at a target that is a minimum distance of 15 m (15 yd.) away.

NOTE: If you set your primary pin for farther distances, such as 30 m (33 yd.), you will have a farther maximum range, but

you will decrease visibility of closer targets. If you set your primary pin for shorter distances, you will have greater visibility of close targets, but a shorter maximum range.

- 2 Nock an arrow, and draw your bow.
- 3 Looking through your bow's peep sight at full draw, align the primary pin ① with the center of the target ②.

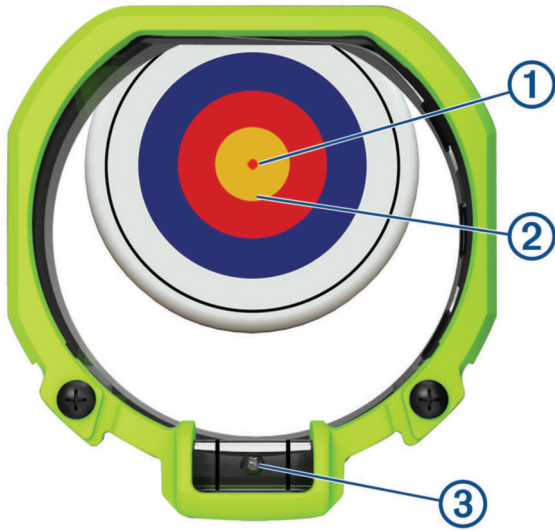

- 4 Confirm the bubble in the level ③ is centered between the lines.
- 5 Shoot at the target, and observe the point of impact.
- 6 Using a 7/64 inch hex wrench, loosen the vertical ④ adjustment on the mount.

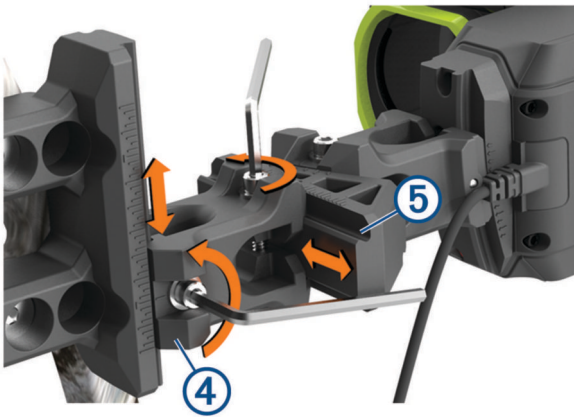

- 7 Move the vertical adjustment in the direction of the arrow's point of impact.
- 8 Tighten the vertical adjustment to a maximum torque specification of 2.2 N-m (20 lbf-in).
- 9 Using a 7/64 inch hex wrench, loosen the horizontal ⑤ adjustment on the mount.
- 10 Move the horizontal adjustment in the direction of the arrow's point of impact.
- 11 Tighten the horizontal adjustment to a maximum torque specification of 2.2 N-m (20 lbf-in).
- 12 Continue adjusting the mount, as needed, until the point of aim and the point of impact are the same.

TIP: You should adjust the mount in the direction of the point of impact. For example, if the arrow impacts low and right, you should adjust the mount down and right. You should always tighten the mount screws to a maximum torque specification of 2.2 N-m (20 lbf-in) between adjustments.

Aligning the Rangefinder with the Primary Pin

The circular rangefinder reticle indicates the direction the laser rangefinder is pointing. For best accuracy, you must align the circular rangefinder reticle with the primary pin.

- 1 Nock an arrow.
- 2 Bring the bow to full draw, and align the peep sight with the sight housing ring.
- 3 Observe the arrows ① on the rangefinder reticle.

The arrows indicate the direction you must move the curved adjustments on the mount. Each arrow in the optic corresponds with one degree of adjustment on the curved rails.



- 4 Using a 7/64 inch hex wrench, adjust the curved vertical ② and curved horizontal ③ adjustments on the mount in the directions the arrows indicate. For example, if the arrows point up and right, move the curved mount pieces up and right.

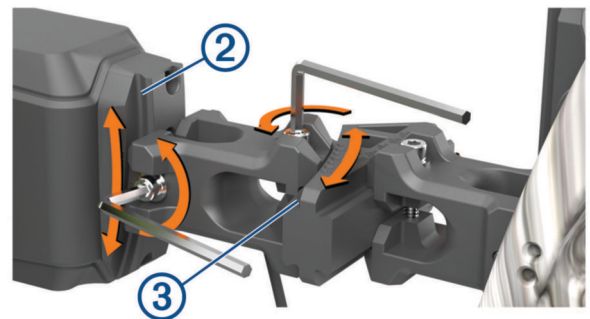

TIP: Each mark on the curved adjustments indicates one degree. Garmin® recommends moving the curved rails in small increments as indicated by the arrows in the optic when making adjustments.

- 5 Continue adjusting the mounts until the primary pin is centered in the circle of the rangefinder reticle ④ at full draw.



6 Tighten the curved adjustments to 2.2 N-m (20 lbf-in).

Adjusting the Bubble Level

The bow sight contains a built-in digital level and a clearly visible bubble level. If the digital level and the bubble level do not match, you can adjust the position of the bubble level.

- 1 Select > **Level** > **View Gauge**.
- 2 Hold the bow sight level so the display shows 0.
- 3 Loosen the two screws located on each side of the bubble level by one quarter turn.
- 4 Adjust the bubble level until the bubble is centered and the digital display also reads 0.
- 5 Tighten the two screws.

Using the Bow Sight

Before you can use the bow sight, you must calibrate it for your bow and arrow combination (*Calibrating the Bow Sight, page 2*).

- 1 Draw your bow.
- 2 Hold the laser rangefinder trigger.
- 3 Align the primary pin with the ranging reticle, and aim at the target.
- 4 While holding the reticle on the target, release the laser rangefinder trigger.
The bow sight displays the measured range and projects a new pin.
- 5 Using the new pin, aim at the target, and shoot the bow.

Rangefinder Measurements

When you activate the laser rangefinder, the device displays three numbers on the LCD display. The device uses these measurements to adjust the position of the pin.

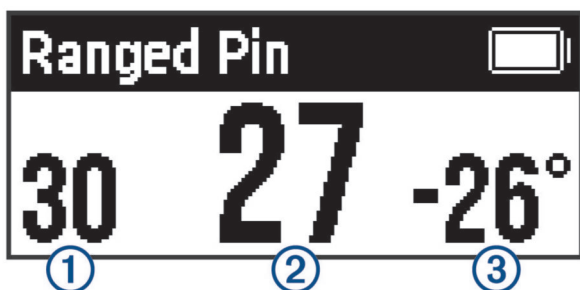

① Line-of-sight distance	The measured distance between the laser rangefinder and the target.
② Adjusted distance	The horizontal distance to the target, which is calculated using the angle of measurement.
③ Angle of measurement	The upward or downward angle from the rangefinder to the target.

Setting a Manual Range

You can set a pin for a specific range manually. This can be useful if your bow sight has low battery power, or if you plan to shoot at a specific range. You can set manual pins only for distances closer than the maximum calibrated range.

- 1 Hold **<** or **>**.
The device changes to manual ranging mode.
- 2 Press **<** or **>** to select a range.

Level Indicator

When enabled, the level indicator shows when you are holding the bow level. Level indicators appear as three dots above or below your aiming pin. The top indicator flashes when the bow is canted to the right. The bottom indicator flashes when the bow is canted to the left. The bow is level when no indicators flash. You can adjust the threshold for the level indicator to allow more or less cant (*Level Settings, page 7*).

NOTE: The level indicator does not appear when using fixed pins.

Main Menu

Press **OK** to open the main menu.

	Enables hunt mode
	Enables practice mode
	Opens the statistics mode menu
	Opens the brightness settings menu
	Opens the arrow profile menu (A1i models only)
	Opens the pin settings menu
	Opens the Laser Locate™ menu (A1i models only)
	Opens the shot dynamics menu
	Opens the device settings menu

Hunt Mode

Hunt mode enables features to help you make ranged shots more quickly. When hunt mode is enabled, shot locations are saved automatically using the Laser Locate feature. This can help you track game when using the bow sight with a compatible handheld GPS device.

NOTE: The Laser Locate feature is available only on A1i models.

Practice Mode

Practice mode enables features to help you improve your accuracy when practicing. After each shot, the bow sight automatically displays your shot dynamics for the current shooting session. You can use this information to make more consistent shots.

NOTE: Shot dynamics features are available only on A1i models.

Statistics Mode

Statistics mode enables features to help you track your accuracy during a shooting session. You can review the statistics data to view your shot consistency and accuracy trends at different distances over time.

Recording Statistics

- 1 Select  > **Stats Mode**.
- 2 Follow the on-screen instructions to enter the current date.
- 3 Select the number of arrows you will be using for each group of shots.
- 4 Range your target.
- 5 Select **Yes** to confirm the range.
- 6 Shoot a group of shots at your target.
- 7 Select **Yes** to score the group.
- 8 Enter the distance of the center of the shot group, left or right, from the center of the target.
- 9 Enter the distance of the center of the shot group, up or down, from the center of the target.
- 10 Enter the diameter of the shot group.
- 11 If necessary, select **Yes** to record additional shot groups.

Viewing Statistics History

- 1 Select  > **Stats History**.
- 2 Select a range.
- 3 Press **<** or **>** to move through shot statistics.

Shot Statistics

Select  > **Stats History**.

Avg. Group Direction: The average direction of each shot group from the center of the target.

Abs. Accuracy: The average spread of your shots related to the center of the target.

Avg. Precision: The average diameter of shot groups.

Abs. Level: The average amount of cant, left or right, when shooting the bow.

Avg. Range: The average range of shots taken.

Avg. Shots/Sess.: The average number of shots per shooting session.

Tot. Stats Shots: The total number of shots taken when using statistics mode.

Total Groups: The total number of groups fired when using statistics mode.

Total Sessions: The total number of shooting sessions recorded when using statistics mode.

Viewing Statistics Files on a Computer

Before you can view statistics files on your computer, you must record shots using statistics mode ([Statistics Mode, page 4](#)).

You can view and transfer statistics files by connecting the device to your computer. Statistics files are saved in CSV file format.

- 1 Connect the device to your computer ([Connecting the Device to Your Computer, page 8](#)).
- 2 Open the device directory for your bow sight on your computer.
- 3 Select **GARMIN > STATS**.

Clearing Stats Mode History

Select  > **Clear Stats Mode History**.

Adjusting Brightness

The bow sight contains an ambient light sensor to set your pin and reticle brightness automatically. You can adjust your pin and reticle brightness preferences if you prefer a different level of brightness. You can also adjust the pin brightness quickly by pressing **<** or **>**.

- 1 From the main menu, select .
- 2 Select an option:
 - To adjust the pin brightness, select **Pins**.

- To adjust the rangefinder reticle brightness, select **Reticle Brightness**.
- To adjust the screen backlight brightness, select **Backlight**.
- To change the backlight timeout, select **Backlight Timeout**.
- To enable or disable the ambient light sensor, select **Light Sensor**.
- To enable or disable the rangefinder reticle, select **Reticle**.

Adding Arrow Profiles

NOTE: Arrow profiles are available only on A1i models.

You can add arrow profiles for use with different arrows, draw lengths, or draw weights. You should set a different arrow profile for each arrow type you use, or for each time you change your bow configuration.

- 1 From the main menu, select  > **Add Arrow Profile**.
- 2 Enter a name for the arrow profile.

TIP: You can press **<** or **>** to move through the menu. You can press **OK** to enter a letter.
- 3 Select  to confirm the name.
- 4 Select **Yes** to begin calibrating the arrow profile.

Managing Arrow Profiles

- 1 From the main menu, select .
- 2 Select an arrow profile.
- 3 Select an option:
 - To activate the profile, select **Activate**.
 - To edit the profile name, select **Edit Name**.
 - To reset all calibration data for the current profile, select **Reset Profile**.
 - To delete the profile, select **Delete**.

Pin Calibration

Calibrating Additional Ranges

You can add ranged pins to extend the range of your shots. Garmin recommends calibrating a range for every 10 meters or yards. Calibrated ranges apply only to the active arrow profile. The bow sight will not provide pins beyond the farthest calibrated range.

- 1 From the main menu, select .
- 2 Select **Calibrated Ranges > Add Range**.
- 3 Follow the on-screen instructions on your bow sight to calibrate the device for the new distance.

Fixed Pins

You can set the bow sight to use fixed pins for multiple ranges. This enables the bow sight to work like a conventional fixed pin sight. Fixed pins have a lower power requirement than the laser rangefinder, and you can use fixed pins if your battery is too low to range. You can set fixed pins for any range between the highest and lowest calibrated ranges.

When using hunt mode or practice mode, you can press  or quickly tap the ranging trigger to display fixed pins at any time.

Setting Fixed Pins

Before you can set fixed pins, you must calibrate the bow sight for your current bow and arrow combination ([Calibrating the Bow Sight, page 2](#)).

- 1 From the main menu, select .
- 2 Select **Fixed Pins > Add Pin**.
- 3 Select a range.

- 4 If necessary, repeat steps 2 and 3 to add additional fixed pins.

Changing the Fixed Pin Color

NOTE: Pin color options are available only on A1i models.

There is a small offset between red and green pins. Most archers will not see changes in accuracy for shots within 45 m (50 yd.). Garmin recommends choosing only one color of pin when setting fixed pins for distances longer than 45 m (50 yd.).

- 1 From the main menu, select  > **Fixed Pins**.
- 2 Select a pin.
- 3 Select **Color**.
- 4 Select a color.

Deleting Fixed Pins

- 1 From the main menu, select  > **Fixed Pins**.
- 2 Select a pin.
- 3 Select **Delete Pin**.

Laser Locations

NOTE: The Laser Locate feature is available only on A1i models.

When your bow sight is in hunt mode, it creates a record of the heading and ranged distance each time you range a target. You can send this data to a compatible Garmin watch or handheld device. This can be useful to help you create waypoints or track game. Laser locations appear in the XERO Locations widget or app on your compatible device. You can adjust the broadcast settings from the settings menu on your bow sight ([Laser Location Settings, page 6](#)).

NOTE: You may need to update the software for your compatible watch or handheld device before you can use the XERO Locations app ([Product Updates, page 7](#)).

Sending Locations to a Device

You can manually send ranged locations to a compatible Garmin watch or handheld device.



- 1 From the main menu, select .
- 2 Select a ranged location.
- 3 Select **Yes**.

The bow sight sends the selected location to your compatible Garmin device.

Viewing Shot Dynamics

NOTE: Some shot dynamics measurements are available only on A1i models.

When you use the device in practice mode, the device records statistics about your shot dynamics. You can use this feature as a reference to help you improve your accuracy.

- 1 From the main menu, select .
- 2 Press  or  to scroll through recorded shot statistics.

Shot Dynamics

Impulse Duration: A measurement of the amount of time the bow vibrated after the shot.

Roll: A measurement in degrees of the bow's tilt when taking a shot.

Shots: The number of shots taken during the current shooting session.

Total Shots: The total number of shots taken.

Device Settings

The device settings allow you to customize the device for your needs.

From the main menu, select .

Pins: Sets the appearance and timeout of the pins on your bow sight ([Pin Settings, page 6](#)).

Align Reticle: Turns on the rangefinder reticle and primary pin. You can use this option to align the rangefinder reticle and primary pin, as needed.

Laser Locations: Sets the broadcast mode for laser locations ([Laser Location Settings, page 6](#)).

NOTE: This setting is available only on A1i models.

Shot Dynamics: Enables or disables shot notifications and clears shot history ([Shot Dynamics Settings, page 6](#)).

NOTE: Some shot measurements are available only on A1i models.

Units: Sets the units of measurement used by the device ([Units Settings, page 7](#)).

Language: Sets the device language.

Level: Displays the angle of the bow and allows you to display a level indicator when shooting ([Level Settings, page 7](#)).

Calibrate Compass: Allows you to calibrate the compass if you experience irregular compass behavior, for example, after moving long distances or after extreme temperature changes ([Calibrating the Compass, page 7](#)).

NOTE: This setting is available only on A1i models.

Manual Adjustment: Sets the position of pins within the device optic. You can move the position of the calibrated range stack ([Moving the Calibrated Range Stack, page 7](#)) or customize the position of the top pin ([Customizing the Position of the Top Pin, page 7](#)).

Reset All Settings: Resets all settings to factory default values.

About: Displays regulatory and compliance information.

Pin Settings

Pin settings allow you to customize the appearance of pins and the length of time pins are displayed on your bow sight.

From the main menu, select  > **Pins**.

Hunt Timeout: Sets the length of time before a ranged pin disappears when using hunt mode.

Practice Timeout: Sets the length of time before a ranged pin disappears when using practice mode.

Ranged Pin Color: Sets the color of the ranged pin.

NOTE: This setting is available only on A1i models.

Laser Location Settings

From the main menu, select  > **Laser Locations**.

NOTE: The Laser Locate feature is available only on A1i models.

Broadcast Mode: Sets the security of laser location broadcasting.

Shot Dynamics Settings

From the main menu, select  > **Shot Dynamics**.

NOTE: The shot dynamics options are available only on the A1i model.

Shot Notifications: Enables or disables notifications after each shot.

Competition File: Enables the device to record shot dynamics to a file stored on the device. This can be useful to review shots taken during a tournament.

Clear Session Shot Odometer: Clears the shot history for the current session.

Clear Total Shot Odometer: Clears the entire shot history stored on the bow sight.

Units Settings

From the main menu, select  > **Units**.

Distance: Sets the unit of measure for distance.

Decimal Precision: Shows more precise measurements for the laser rangefinder. Measurements are rounded to the nearest tenth of a meter or yard.

Level Settings

From the main menu, select  > **Level**.

View Gauge: Displays the angle of the bow. You can use this option to adjust the position of the bubble level.

Set Level to Zero: Sets the electronic level to zero. You can use this option if you have mechanically leveled your bow but the digital level does not read zero.

Indicators: Sets level indicators to appear when shooting. This can help you hold the bow level while aiming (*Level Indicator, page 4*).

Threshold: Sets the amount of degrees of cant allowed before the indicators flash. A lower threshold reduces the amount of cant allowed.

Indicator Color: Sets the color of the level indicator.

NOTE: This setting is available only on A1i models.

Calibrating the Compass

NOTE: You must calibrate the electronic compass outdoors. Do not stand near objects that influence magnetic fields, such as cars, buildings, or overhead power lines.

Your device was already calibrated at the factory, and the device uses automatic calibration by default. If the Laser Locate feature is not working properly, for example, after moving long distances or after extreme temperature changes, you can manually calibrate the compass.

NOTE: The Laser Locate and compass features are available only on A1i models.

- 1 From the main menu, select  > **Calibrate Compass**.
- 2 Follow the on-screen instructions.

Customizing the Position of the Top Pin

For bow configurations that require additional vertical adjustment, you can customize the position of the top pin. This can also be useful for people who prefer the short range pins to be more centered within the device optic.

NOTE: Changing the position of the top pin clears all arrow profile settings.

- 1 From the main menu, select  > **Manual Adjustment** > **Custom Top Pin Placement**.
- 2 Select **Yes**.
- 3 Press **<** or **>** to adjust the position of the top pin.
- 4 Press **OK**.
- 5 Follow the on-screen instructions to calibrate the device for the new top pin position (*Setting the Primary Pin, page 2*).

Moving the Calibrated Range Stack

You can move the calibrated pins up or down to allow more adjustment in the direction of your choice. For example, if your primary pin is set at 20 yards, and your maximum pin is set at 70 yards, you can move the range stack up so you can add pins for farther ranges. Alternatively, you can move the calibrated range stack down so your pins are more centered within the device optic. You must adjust your mechanical alignment after moving the calibrated range stack. Moving the calibrated range stack updates all arrow profile settings.

NOTE: The device stores pins that are positioned above or below the optic. These pins are still listed as calibrated ranges, and can be moved back onto the optic at any time.

- 1 From the main menu, select  > **Manual Adjustment** > **Move Calibrated Range Stack**.
- 2 Select **Yes**.
- 3 Press **<** or **>** to adjust the position of the range stack.
- 4 Press **OK**.
- 5 Follow the on-screen instructions to calibrate the device for the new stack position (*Setting the Primary Pin, page 2*).

Device Information

Device Specifications

Battery type	Replaceable 1.5 V AAA lithium
Battery life	Up to 25,000 laser ranges Up to 1 year in standby mode
Operating temperature range	From -20° to 60°C (from -4° to 140°F) NOTICE Do not expose the device to temperatures above 60°C (140°F).
Storage temperature range	From -20° to 60°C (from -4° to 140°F)
Water rating	IEC 60529 IPX7 ¹
Wireless frequency/protocol	ANT [®] 2.4 GHz @ 4 dBm nominal

Viewing E-label Regulatory and Compliance Information

The label for this device is provided electronically. The e-label may provide regulatory information, such as identification numbers provided by the FCC or regional compliance markings, as well as applicable product and licensing information.

- 1 Press **OK** to open the menu.
- 2 Select .
- 3 Select **About**.

Product Updates

On your computer, install Garmin Express™ (www.garmin.com/express).

This provides easy access to these services for Garmin devices:

- Software updates
- Product registration

Updating the Software Using a Computer

You can use Garmin Express software to download and install the latest software updates for your device. Garmin Express is available for Windows® and Mac® computers.

- 1 On your computer, go to garmin.com/express.
- 2 Select an option:
 - To install on a Windows computer, select **Download for Windows**.
 - To install on a Mac computer, select **Download for Mac**.
- 3 Open the downloaded file, and follow the on-screen instructions to complete the installation.
- 4 Open the Garmin Express application.
- 5 Connect your Xero device to your computer using a micro-USB cable (*Connecting the Device to Your Computer, page 8*).

¹ The device withstands incidental exposure to water of up to 1 m for up to 30 min. For more information, go to www.garmin.com/waterrating.

- 6 From the Garmin Express application, click **Add a Device**.
The Garmin Express software detects your device.
- 7 Click **Add Device**.
- 8 Follow the on-screen instructions to register your device and add it to the Garmin Express software.
When setup is complete, the Garmin Express software searches for software updates for your device.
- 9 Select an option:
 - To install all available updates, click **Install All**.
 - To install a single update, click **View Details**, and select an update.
- 10 When the software update is complete, disconnect the device from your computer.
- 11 Reinstall the battery door.
The device installs the software update.

Connecting the Device to Your Computer

Before you can connect the device to your computer, you may need to remove optional mount accessories.

- 1 Using a 5/64 inch hex wrench, loosen the four screws securing the battery door.
- 2 Remove the battery door, and set it aside.
NOTE: Do not remove the batteries.
- 3 Plug the small end of the USB cable into the USB port ① on the device.

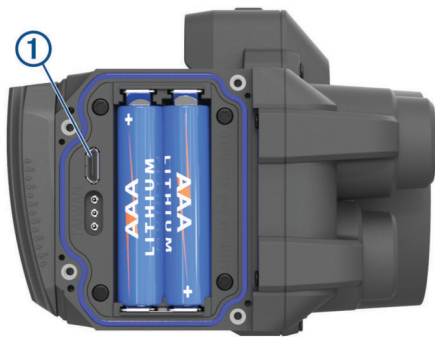

- 4 Plug the large end of the USB cable into a computer USB port.
- 5 If the bow sight is turned off, press **↵** to turn on the device.
The bow sight enters USB mass storage mode.

Device Care

NOTICE

Avoid extreme shock and harsh treatment, because it can degrade the life of the product.

Do not use a sharp object to clean the device.

Avoid chemical cleaners, solvents, and insect repellents that can damage plastic components and finishes.

Do not store the device where prolonged exposure to extreme temperatures can occur, because it can cause permanent damage.

Cleaning the Device

- 1 Dampen a soft, clean, lint-free cloth with fresh water.
- 2 Gently wipe the device.

Getting More Information

You can find more information about this product on the Garmin website.

- Go to support.garmin.com.

- Go to www.garmin.com/outdoor.
- Go to <http://buy.garmin.com>, or contact your Garmin dealer for information about optional accessories and replacement parts.

Troubleshooting

The point of impact moves between shots

There are several factors that can cause variations in the point of impact.

- Verify the screws that connect the mount to the riser are tightened to the maximum torque specification of 6.7 N-m (60 lbf-in) and the mount cannot be moved on the bow.
NOTE: Do not exceed the bow manufacturer's recommended torque values.
- Verify each adjustment point on the mount is tightened to the maximum torque specification of 2.2 N-m (20 lbf-in).
- Verify you are using the correct arrow profile for the arrow you are using (A1i models only).
- Range your shots consistently at full draw or at rest.
- Inspect your bow and confirm all components are in good working condition.
- Always use consistent form when shooting a bow. Variations in stance and peep sight placement can affect accuracy.

My device only displays fixed pins

When the batteries are low or do not meet the minimum power requirements for the laser rangefinder, the device allows only fixed pin sighting.

- Verify the battery level of the batteries you have installed.
- Verify you are using AAA lithium batteries.

Tips for Consistent Ranging

If you are a target shooter, consistent ranging can help to increase your accuracy.

- Use the rangefinder consistently while you are using the same form (at full draw or at rest).
- Enable decimal precision (*Units Settings, page 7*).
- Verify you are aiming the reticle at the target when you release the ranging trigger.

Resetting the Device

If the device stops responding, you may need to reset it. This does not erase any of your saved data or settings.

- 1 Hold **↵** for 12 seconds.
The device turns off.
- 2 Hold **↵** for one second to turn on the device.

Index

A

accessories **8**
arrow profiles **5**

B

backlight **5**
battery **7**
 installing **1**
bow sight, using **4**
brightness **5**
buttons **1**

C

calibrating the sight **2**
cleaning the device **8**
compass, calibrating **7**
computer, connecting **8**

D

data, transferring **8**
deleting, history **5**
device, cleaning **8**

F

fixed pins **4–6**

G

Garmin Express, updating software **7**

H

hunt mode **4**

L

laser locations **6**
laser rangefinder **4**
level **4**
 settings **7**
locations, sending **6**

M

main menu **4**
mounting the device **1, 2**

P

power key **2**
practice mode **4**

R

resetting the device **8**

S

settings **6, 7**
shot dynamics **6**
sighting in the device **2–5**
software, updating **7**
specifications **7**
 torque **2**
statistics **4, 5**
storing data **8**

T

troubleshooting **7, 8**

U

updating, software **7**

V

video tutorials **1**

W

water rating **7**

