

GARMIN®



**DÉZL™ OTR810 / OTR1010 /
LGV810 / LGV1010**

Owner's Manual

© 2022 Garmin Ltd. or its subsidiaries

All rights reserved. Under the copyright laws, this manual may not be copied, in whole or in part, without the written consent of Garmin. Garmin reserves the right to change or improve its products and to make changes in the content of this manual without obligation to notify any person or organization of such changes or improvements. Go to www.garmin.com for current updates and supplemental information concerning the use of this product.

Garmin® and the Garmin logo are trademarks of Garmin Ltd. or its subsidiaries, registered in the USA and other countries. These trademarks may not be used without the express permission of Garmin.

BC™, dēzl™, Garmin eLog™, Garmin Express™, and myTrends™ are trademarks of Garmin Ltd. or its subsidiaries. These trademarks may not be used without the express permission of Garmin.

Android™ is a trademark of Google LLC. Apple® and Mac® are trademarks of Apple Inc, registered in the U.S. and other countries. The Bluetooth® word mark and logos are owned by the Bluetooth SIG, Inc., and any use of such word mark or logo by Garmin is under license. microSD® and the microSDHC logo are trademarks of SD-3C, LLC. Love's® and Love's Travel Stops® are registered trademarks of Love's Travel Stops & Country Stores, Inc. Pilot Flying J™ and Pilot Flying J Travel Centers™ are trademarks of Pilot Travel Centers LLC and its affiliate companies. PrePass® is a trademark of the PrePass Safety Alliance. Tripadvisor® is a registered trademark of TripAdvisor LLC. TruckDown® is the trademark of TruckDown Info International, Inc. Windows® is a registered trademark of Microsoft Corporation in the United States and other countries. Wi-Fi® and Wi-Fi CERTIFIED MiraCast™ are registered marks of Wi-Fi Alliance Corporation.

Table of Contents

Getting Started.....	1	Finding Truck Parking in Europe.....	16
Device Overview.....	1	Finding Parking Near Your Current	
Mounting and Powering the Device in		Location.....	16
Your Vehicle.....	2	Search Tools.....	16
Installing the Screw-Down Mount on		Finding an Intersection.....	16
the Dashboard.....	4	Finding a Location Using	
Installing the Ball Mount Adapter.....	5	Coordinates.....	16
Turning the Device On or Off.....	6	Tripadvisor.....	16
Acquiring GPS Signals.....	6	Finding Tripadvisor Points of	
Home Screen.....	7	Interest.....	17
Opening an App.....	7	Viewing Recently Found Locations.....	17
Adding Shortcuts to the Home		Clearing the List of Recently Found	
Screen.....	8	Locations.....	17
Viewing Notifications.....	8	Viewing Current Location	
Status Bar Icons.....	8	Information.....	17
Using the Touchscreen.....	8	Finding Emergency Services and	
Adjusting the Screen Brightness.....	8	Fuel.....	17
Vehicle Profiles.....	9	Getting Directions to Your Current	
Adding a Vehicle Profile.....	9	Location.....	17
Car Profile.....	9	Adding a Shortcut.....	17
Switching the Vehicle Profile.....	9	Removing a Shortcut.....	18
Changing Your Trailer Information.....	10	Saving Locations.....	18
Editing a Vehicle Profile.....	10	Saving a Location.....	18
Driver Awareness Features and		Saving Your Current Location.....	18
Alerts.....	11	Editing a Saved Location.....	18
Enabling or Disabling Driver Alerts.....	11	Assigning Categories to a Saved	
Red Light and Speed Cameras.....	12	Location.....	18
Finding and Saving Locations.....	12	Deleting a Saved Location.....	19
Points of Interest.....	12	Navigating to Your Destination.....	19
Finding Trucking Points of Interest.....	12	Routes.....	19
Finding a Location Using the Search		Starting a Route.....	19
Bar.....	13	Starting a Route by Using the Map...	19
Finding an Address.....	13	Going Home.....	19
Finding a Location by Category.....	13	Your Route on the Map.....	20
Searching Within a Category.....	13	Active Lane Guidance.....	21
Location Search Results.....	14	Viewing Popular Truck Paths on the	
Changing the Search Area.....	15	Map.....	22
Custom Points of Interest.....	15	Viewing Turns and Directions.....	22
Installing POI Loader.....	15	Viewing the Entire Route on the	
Finding Custom POIs.....	15	Map.....	22
Parking.....	16	Planning Your Arrival.....	22
Finding Truck Parking.....	16	Arriving at Your Destination.....	22
		Completing a Truck Route.....	23
		Parking Near Your Destination.....	23
		Changing Your Active Route.....	24
		Adding a Location to Your Route.....	24
		Shaping Your Route.....	24

Taking a Detour.....	24	Receiving Notifications.....	33
Changing the Route Calculation Mode.....	24	Hands-Free Calling.....	33
Stopping the Route.....	24	Placing a Call.....	33
Using Suggested Routes.....	25	Receiving a Call.....	33
Avoiding Delays, Tolls, and Areas.....	25	Using In-Call Options.....	34
Avoiding Traffic Delays on Your Route.....	25	Saving a Phone Number as a Preset.....	34
Avoiding Road Features.....	25	Wireless Headsets.....	34
Avoiding Environmental Zones.....	25	Enabling or Disabling Bluetooth Features.....	34
Custom Avoidances.....	25	Showing or Hiding App Notifications (Android™).....	34
Using the Map.....	26	Showing or Hiding Notification Categories for Your Apple® Device.....	34
Map Tools.....	27	Disconnecting a Bluetooth Device.....	34
Viewing a Map Tool.....	27	Deleting a Paired Bluetooth Device.....	35
Up Ahead.....	27	Deleting a Paired Phone.....	35
Viewing Upcoming Locations.....	28	Traffic.....	35
Customizing the Up Ahead Categories.....	28	Receiving Traffic Data Using Your Smartphone.....	35
Cities Ahead.....	28	Viewing Traffic on the Map.....	35
Viewing Upcoming Cities and Exit Services.....	28	Searching for Traffic Incidents.....	35
Warning and Alert Symbols.....	28	photoLive Traffic Cameras.....	35
Restriction Warnings.....	29	Viewing and Saving photoLive Traffic Cameras.....	36
Road Condition Warnings.....	29	Saving a Traffic Camera.....	36
Alerts.....	30	Vehicle and Driver Tools.....	36
Trip Information.....	30	Break Planning.....	36
Viewing Trip Data from the Map.....	30	Taking a Suggested Break.....	36
Viewing Your Trip History.....	30	Starting the Break Timer.....	36
Resetting Trip Information.....	30	Pausing and Resetting the Break Timer.....	37
Viewing Upcoming Traffic.....	30	Adjusting Drive Hours.....	37
Viewing Traffic on the Map.....	30	Adjusting the Daily Driving Limit.....	37
Searching for Traffic Incidents.....	31	IFTA.....	37
Customizing the Map.....	31	Entering Fuel Data.....	37
Customizing the Map Layers.....	31	Editing Fuel Data.....	38
Changing the Map Data Field.....	31	Viewing and Exporting a Jurisdiction Summary.....	38
Changing the Map Perspective.....	31	Editing and Exporting Trip Reports..	38
Live Services, Traffic, and Smartphone Features.....	31	Viewing Exported Jurisdiction Summaries and Trip Reports.....	38
Pairing with Your Smartphone.....	32	Logging Service History.....	39
Tips After Pairing the Devices.....	32	Adding Service Categories.....	39
Pairing Additional Bluetooth Devices.....	32	Deleting Service Categories.....	39
Going to an Address or Location Using the dēzl App.....	32		
Smart Notifications.....	33		

Renaming Service Categories.....	39	Voice Command.....	52
Deleting Service Records.....	39	Tips for Speaking to the Device.....	52
Editing a Service Record.....	39	Launching Garmin Voice-Activated	
PrePass®.....	40	Navigation.....	52
Loyalty Programs.....	40	Checking Your Arrival Time.....	52
Garmin eLog.....	40	Placing a Phone Call Using Your	
Setting Up Your Garmin eLog		Voice.....	52
Adapter.....	40	Changing Device Settings Using Your	
Transferring Garmin eLog Data from		Voice.....	53
Another Device.....	40	Using the Apps.....	53
Backing Up Data.....	41	Viewing the Owner's Manual on	
Restoring Data.....	41	Your Device.....	53
Daily Operation Guidelines.....	41	Viewing the Truck Map.....	53
Starting a Drive.....	41	Route Planner.....	53
Garmin eLog App Overview.....	42	Planning a Route.....	53
Garmin eLog Map Tool Overview.....	44	Editing and Reordering Locations in a	
Driving in a Team.....	45	Route.....	54
Changing Duty Status.....	45	Changing Routing Options for a	
Viewing Hours of Service.....	46	Route.....	54
Recording Adverse Conditions.....	46	Navigating to a Saved Route.....	54
Reviewing Logs.....	46	Editing and Saving Your Active	
Certifying Daily Logs.....	46	Route.....	54
Submitting a Daily Log.....	46	Viewing Previous Routes and	
Exporting and Saving a Record of Duty		Destinations.....	54
Status (RODS) Report.....	47	Viewing the Weather Forecast.....	54
Recording Trailers and Shipments...	47	Viewing Weather Near a Different	
Roadside Inspection.....	47	City.....	55
Viewing Inspection Information.....	47	Music Player.....	55
Transferring Data to an Inspector		Adding the Music Player Tool to the	
Using Web Services.....	47	Map.....	55
Transferring Data to an Inspector		Garmin PowerSwitch™ App.....	56
Using Email.....	47	Activating a Power Switch.....	56
Transferring Data to an Inspector		Turning Off All Switches.....	56
Using a USB Device.....	48	Customizing a Button.....	57
Transferring Data to an Inspector		Assigning a Switch to a Control	
Using Bluetooth Wireless		Input.....	57
Technology.....	48	Adding a Custom Layout.....	57
Diagnostics and Malfunctions.....	48	Routines.....	58
Viewing Diagnostics and		Settings.....	59
Malfunctions.....	49	Navigation Settings.....	59
Diagnostic Definitions.....	49	Map and Vehicle Settings.....	60
Malfunction Definitions.....	50	Enabling Maps.....	60
Administrator Functions.....	51	Connecting to a Wireless Network.....	60
Adding Driver Profiles.....	51	Enabling Bluetooth Wireless	
Editing a Driver Profile.....	51	Technology.....	60
Clearing Garmin eLog App Data.....	52		

Driver Assistance Settings.....	60
Traffic Settings.....	60
Display Settings.....	61
Sound and Notification Settings.....	61
Adjusting Sound and Notification Volume.....	61
Enabling or Disabling Location Services.....	61
Setting the Text Language.....	61
Date and Time Settings.....	61
Device Settings.....	62

Device Information..... 62

Viewing E-label Regulatory and Compliance Information.....	62
Specifications.....	62
Charging the Device.....	62

Device Maintenance..... 62

Garmin Support Center.....	62
Updating Maps and Software Using a Wi-Fi Network.....	63
Updating Maps and Software with Garmin Express.....	64
Installing Garmin Express.....	65
Device Care.....	65
Cleaning the Outer Casing.....	65
Cleaning the Touchscreen.....	65
Avoiding Theft.....	65
Resetting the Device.....	65
Removing the Device, Mount, and Suction Cup.....	65
Removing the Mount from the Suction Cup.....	65
Removing the Suction Cup from the Windshield.....	66

Troubleshooting..... 66

The suction cup will not stay on my windshield.....	66
The mount does not hold my device in place while I drive.....	66
My device is not acquiring satellite signals.....	66
The device does not charge in my vehicle.....	66
My battery does not stay charged for very long.....	66

My device does not connect to my phone.....	67
--	----

Appendix..... 67

Garmin PowerSwitch.....	67
Mounting Considerations.....	67
Mounting the Device.....	68
Opening the Front Cover.....	69
Connecting Accessories.....	70
Connecting a Control Input.....	70
Connecting the Device to Vehicle Power.....	71
Pairing with a Garmin Navigation Device.....	71
Garmin PowerSwitch Specifications.....	72
Troubleshooting.....	72
Wireless Cameras.....	72
Pairing a BC™ 50 Backup Camera with a Garmin Navigation Device.....	73
Connecting a Wired Backup Camera.....	73
Viewing the Backup Camera.....	74
Connecting a Dash Camera to the Powered Mount.....	75
Data Management.....	75
About Memory Cards.....	75
Installing a Memory Card for Maps and Data.....	75
Formatting the Memory Card.....	76
Connecting the Device to Your Computer.....	76
Transferring Data From Your Computer.....	76
Purchasing Additional Maps.....	76
Purchasing Accessories.....	76

Getting Started

⚠ WARNING

See the *Important Safety and Product Information* guide in the product box for product warnings and other important information.

- Update the maps and software on your device ([Updating Maps and Software Using a Wi-Fi Network](#), page 63).
- Mount the device in your vehicle and connect it to power ([Mounting and Powering the Device in Your Vehicle](#), page 2).
- Adjust the volume ([Adjusting Sound and Notification Volume](#), page 61) and display brightness ([Adjusting the Screen Brightness](#), page 8).
- Set up a vehicle profile for your truck ([Adding a Vehicle Profile](#), page 9).
- Navigate to your destination ([Starting a Route](#), page 19).

Device Overview

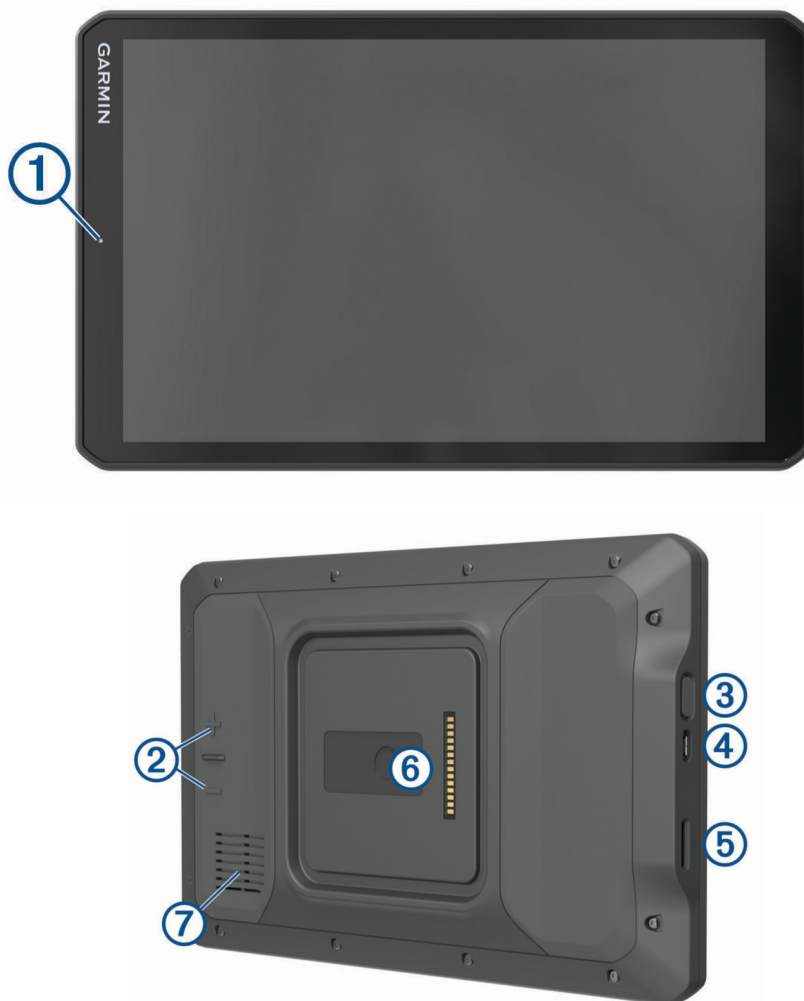

①	Microphone for hands-free calling and voice command
②	Volume control
③	Power key
④	USB power and data port
⑤	Map and data memory card slot
⑥	Magnetic mount interface with 14-pin connector
⑦	Speaker

Mounting and Powering the Device in Your Vehicle

⚠ WARNING

This product contains a lithium-ion battery. To prevent the possibility of personal injury or product damage caused by battery exposure to extreme heat, store the device out of direct sunlight.

Both the device and its mount contain magnets. Under certain circumstances, magnets may cause interference with some internal medical devices and electronic devices, including pacemakers, insulin pumps, or hard drives in laptop computers. Keep the device away from medical devices and electronic devices.

Before you use your device on battery power, you should charge it.

- 1 Open the lever ①, press the suction cup to the windshield, and flip the lever back toward the windshield. The lever must be oriented toward the top of the windshield.



- 2 Plug the vehicle power cable into the port ② on the mount.

- 3 If necessary, loosen the thumbscrew on the suction cup arm ③ and the nut on the ball mount ④, and adjust the mount for better viewing and operation.



- 4 Tighten the thumbscrew on the suction cup arm and the nut on the ball mount.
5 Place the device onto the magnetic mount.



- 6 Plug the other end of the vehicle power cable into a power outlet in your vehicle.

Installing the Screw-Down Mount on the Dashboard

Before you can attach the screw-down ball mount to your dashboard, you must select a suitable location on the dashboard.

⚠ WARNING

It is your responsibility to ensure the mounting location complies with all applicable laws and ordinances, and does not block your view of the road during the safe operation of your vehicle.

NOTICE

Avoid wires, gauges, air bags, air bag covers, HVAC, and other items when drilling pilot holes and attaching the mount to the vehicle. Garmin® is not responsible for any damages or consequences arising from the installation.

NOTICE

To avoid possible damage to your vehicle, Garmin recommends professional installation of the screw-down ball mount.

- 1 Place the mount ① on the selected location.

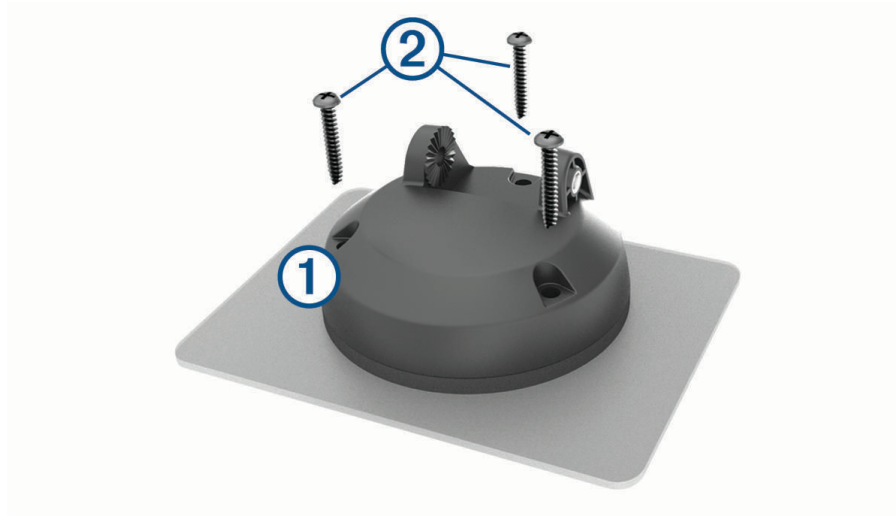

- 2 Using the mount as a template, mark the three screw locations.
- 3 Drill pilot holes (optional).
For some types of mounting material, drilling pilot holes is necessary.
- 4 Securely fasten the mount to the surface using the supplied screws ②.

- 5 Insert the ball mount arm ③ into the mount.

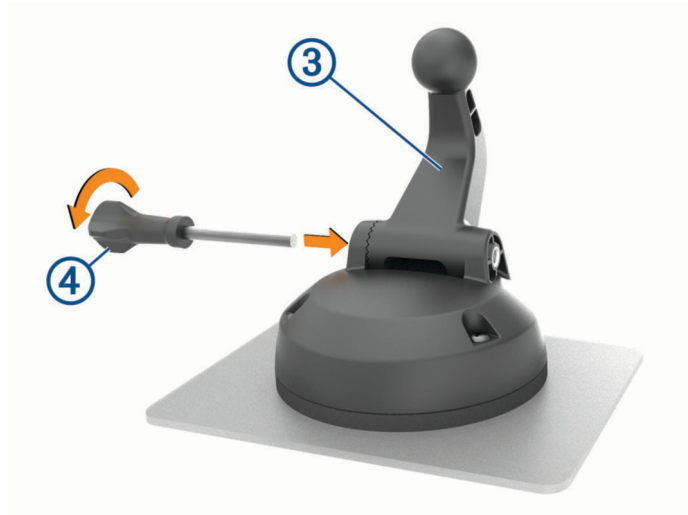

- 6 Insert the thumbscrew ④ into the mount, and tighten it to secure the ball mount arm.

Installing the Ball Mount Adapter

Your device includes a one-inch ball mount that is compatible with third-party mounting solutions.

- 1 Remove the four screws ① securing the mount socket ② to the magnetic mount.



- 2 Remove the mount socket.

- 3 Secure the one-inch ball mount ③ to the magnetic mount using the screws removed in step 1.



Turning the Device On or Off

- To turn the device on, press the power key **1**, or connect the device to power.



- To put the device in power saving mode, press the power key while the device is on. While in power saving mode, the screen is off and the device uses very little power, but it can wake instantly for use.
TIP: You can charge your device faster by putting it in power saving mode while charging the battery.
- To turn off the device completely, hold the power key until a prompt appears on the screen, and select **Power off**.

Acquiring GPS Signals

When you turn on your navigation device, the GPS receiver must collect satellite data and establish the current location. The time required to acquire satellite signals varies based on several factors, including how far you are from the location where you last used your navigation device, whether you have a clear view of the sky, and how long it has been since you last used your navigation device. The first time you turn on your navigation device, it may take several minutes to acquire satellite signals.

- 1 Turn on the device.
- 2 Verify  appears in the status bar, and enable location services if it does not ([Enabling or Disabling Location Services, page 61](#)).
- 3 If necessary, go to an open area with a clear view of the sky, away from tall buildings and trees. Acquiring Satellites appears at the top of the navigation map until the device determines your location.

Home Screen

NOTE: The home screen layout may vary if it has been customized.



- ① Swipe down to view notifications. Swipe down twice to quickly change settings and backlight brightness.
- ② Select to start a route.
- ③ Select to view the map.
- ④ Select to change your vehicle profile.
- ⑤ Select to view weather information for your current location. The dēzl app is required.
- ⑥ Select to view smart notifications. The dēzl app is required.
- ⑦ Select to open the app drawer. The app drawer contains shortcuts to all the apps installed on your device.
- ⑧ Hold to customize the wallpaper or add widgets to the home screen.

Opening an App

The home screen contains shortcuts for frequently used apps. The app drawer contains all the apps installed on your device, organized into two tabs. The dēzl tab contains Garmin apps useful for navigation and hours of service recording. The Tools tab contains apps useful for communication and other tasks.

Select an option to open an app:

- Select an app shortcut from the home screen.
- Select , select a tab, and select an app.

Adding Shortcuts to the Home Screen

- 1 Select .
- 2 Select an app tab to view additional applications.
- 3 Hold an application, and drag it to a location on the home screen.

Viewing Notifications







WARNING

Do not read or interact with notifications while driving, because doing so can cause distraction that could lead to an accident resulting in serious personal injury or death.

- 1 Swipe down from the top of the screen.
The list of notifications appears.
- 2 Select an option:
 - To launch the action or app mentioned in the notification, select the notification.
 - To dismiss a notification, swipe the notification to the right.

Status Bar Icons

The status bar is located at the top of the main menu. The status bar icons display information about features on the device.

	Location services is enabled (Enabling or Disabling Location Services, page 61).
	Bluetooth® technology is enabled.
	Connected to a Bluetooth device.
	Connected to a Wi-Fi® network (Connecting to a Wireless Network, page 60).
	Active vehicle profile. Swipe down twice and select to view the vehicle profile settings (Vehicle Profiles, page 9).
	Battery charge level.
	dēzl app connection status (Pairing with Your Smartphone, page 32)

Using the Touchscreen

- Tap the screen to select an item.
- Drag or swipe your finger across the screen to pan or scroll.
- Pinch two fingers together to zoom out.
- Spread two fingers apart to zoom in.

Adjusting the Screen Brightness

You can adjust the brightness manually, using either the notification panel or the settings menu.

- 1 Select an option:
 - Swipe down twice from the top of the screen to expand the quick settings in the notification panel.
 - Select **Settings** > **Device** > **Display** > **Brightness level**.
- 2 Use the slider bar to adjust the brightness.

Vehicle Profiles

WARNING

Entering your vehicle profile characteristics does not guarantee that your vehicle's characteristics will be accounted for in all route suggestions or that you will receive the warning icons in all cases. Limitations may exist in the map data such that your device cannot account for these restrictions or road conditions in all cases. Always defer to all posted road signs and road conditions when making driving decisions.

Routing and navigation are calculated differently based on your vehicle profile. The activated vehicle profile is indicated by an icon in the status bar. The navigation and map settings on your device can be customized separately for each vehicle type.

When you activate a truck vehicle profile, the device avoids including restricted or impassable areas in routes based on the dimensions, weight, and other characteristics you entered for your vehicle.

Adding a Vehicle Profile

You can add a vehicle profile that includes the weight, dimensions, and other characteristics for your vehicle.

- 1 From the home screen, select the vehicle profile widget ([Home Screen, page 7](#)).
- 2 Select an option:
 - To add a straight truck with a permanently attached cargo area, select **Straight Truck**.
 - To add a tractor or a tractor-trailer combination, select **Tractor**.
 - To add a bus, select **Bus**.
- 3 Follow the on-screen instructions to enter the vehicle characteristics.



After you add a vehicle profile, you can edit the profile to enter additional detailed information, such as the vehicle identification number or trailer number ([Editing a Vehicle Profile, page 10](#)).

Car Profile

The car profile is a preloaded vehicle profile intended for use in an automobile without a trailer. While using the car profile, the device calculates standard automobile routes, and routing for large vehicles is not available. Some features and settings specific to large vehicles are not available while using the car profile.

Switching the Vehicle Profile

Each time you turn on your device, it prompts you to select a vehicle profile. You can manually switch to another vehicle profile at any time.

- 1 Select an option:
 - Swipe down twice from the top of the screen, and select the vehicle profile icon, such as  or .
 - From the home screen, select the vehicle profile widget ([Home Screen, page 7](#)).
- 2 Select a vehicle profile.

The vehicle profile information appears, including measurements and weight.
- 3 Select **Select**.

Changing Your Trailer Information





Before you can change your trailer information, you must enter a vehicle profile for a tractor ([Adding a Vehicle Profile, page 9](#)).

When you change the trailer on your tractor, you can change the trailer information in your vehicle profile without changing the tractor information. You can switch quickly between frequently used trailers.

- 1 From the home screen, select the vehicle profile widget ([Home Screen, page 7](#)).
- 2 Select the tractor vehicle profile to use with the trailer.
- 3 Select .
- 4 Select an option:
 - To use a recent trailer configuration, select a trailer configuration from the list.
 - To enter a new trailer configuration, select **New Configuration**, and enter the trailer information.

Editing a Vehicle Profile

You can edit a vehicle profile to change vehicle information or to add detailed information to a new vehicle profile, such as the vehicle identification number, trailer number, or odometer reading. You can also rename or delete a vehicle profile.

- 1 From the home screen, select the vehicle profile widget ([Home Screen, page 7](#)).
- 2 Select the vehicle profile to edit.
- 3 Select an option:
 - To edit the vehicle profile information, select , and select a field to edit.
 - To rename a vehicle profile, select  >  > **Rename Profile**.
 - To delete the vehicle profile, select  >  > **Delete**.

Driver Awareness Features and Alerts

CAUTION

The driver alerts and speed limit features are for information only and do not replace your responsibility to abide by all posted speed limit signs and to use safe driving judgment at all times. Garmin is not responsible for any traffic fines or citations you receive for failing to follow all applicable traffic laws and signs.

Your device provides features that can help encourage safer driving and increase efficiency, even when you are driving in a familiar area. The device plays an audible tone or message and displays information for each alert. You can enable or disable the audible tone for some types of driver alerts. Not all alerts are available in all areas.

Schools: The device plays a tone and displays the speed limit (if available) for an upcoming school or school zone.

Speed limit exceeded: The device displays a red border on the speed limit icon when you exceed the posted speed limit for the current road.

Speed limit reduced: The device plays a tone and displays the upcoming speed limit so you can be prepared to adjust your speed.

Railroad crossing: The device plays a tone to indicate an upcoming railroad crossing.

Animal crossing: The device plays a tone to indicate an upcoming animal crossing area.

Curves: The device plays a tone to indicate a bend in the road.

Slower traffic: The device plays a tone to indicate slower traffic when you approach slower traffic at a higher speed. Your device must be receiving traffic information to use this feature ([Traffic, page 35](#)).

Construction zone: The device plays a tone and displays a message when you approach a construction zone.

Lane closure: The device plays a tone and displays a message when you approach a lane closure.

Break planning: The device plays a tone and suggests upcoming rest stops after you have been driving for a long time.

No trucks allowed: The device plays a tone when you approach a road where no trucks are allowed.

Risk of grounding: The device plays a tone and displays a message when you approach a road where your vehicle could become grounded.

Lateral wind: The device plays a tone and displays a message when you approach a road where there is risk of lateral wind.

Narrow road: The device plays a tone and displays a message when you approach a road that may be too narrow for your vehicle.

Steep hill: The device plays a tone and displays a message when you approach a steep hill.

State and country borders: The device plays a tone and displays a message when you approach the border of a state or country.

Enabling or Disabling Driver Alerts

You can enable or disable several types of driver alerts.

- 1 Select **Settings > Driver Assistance > Driver Alerts**.
- 2 Select or clear the check box next to each alert.

Red Light and Speed Cameras

NOTICE

Garmin is not responsible for the accuracy of or the consequences of using a red light or speed camera database.

NOTE: This feature is not available for all regions or product models.

Information about red light and speed camera locations is available in some areas for some product models. The device alerts you when you approach a reported speed or red light camera.

- In some areas, your device can receive red light and speed camera data while connected to a smartphone running the *dēzl* app.
- You can use the Garmin Express™ software (garmin.com/express) to update the camera database stored on your device. You should update your device frequently to receive the most up-to-date camera information.

Finding and Saving Locations

The maps loaded in your device contain locations, such as restaurants, hotels, auto services, and detailed street information. The Where To? menu helps you find your destination by providing several methods to browse, search, and save this information.

From the main menu, select **Where To?**

- To quickly search all locations on your device, select **Search** (*Finding a Location Using the Search Bar, page 13*).
- To find an address, select **Address** (*Finding an Address, page 13*).
- To browse or search pre-loaded points of interest by category, select **Categories** (*Finding a Location by Category, page 13*).
- To search near a different city or area, select  next to the current search area (*Changing the Search Area, page 15*).
- To view and edit your saved locations, select **Saved** (*Saving Locations, page 18*).
- To view locations you have recently selected from the search results, select **Recent** (*Viewing Recently Found Locations, page 17*).
- To search for truck stops and services, select **Categories > Trucking** (*Finding Trucking Points of Interest, page 12*).
- To browse and search Tripadvisor® traveler ratings, select **Tripadvisor** (*Tripadvisor, page 16*).
- To navigate to specific geographic coordinates, select **Coordinates** (*Finding a Location Using Coordinates, page 16*).

Points of Interest

NOTICE

You are responsible for understanding and complying with any applicable rules, laws, or regulations associated with points of interest.

A point of interest is a place that you may find useful or interesting. Points of interest are organized by category and can include popular travel destinations such as gas stations, restaurants, hotels, and entertainment venues.

Finding Trucking Points of Interest

NOTICE

You are responsible for understanding and complying with any applicable rules, laws, or regulations associated with points of interest.

The detailed maps loaded in your device contain trucking points of interest, such as truck stops, rest areas, and weigh stations.

Select **Where To? > Categories > Trucking**.

Finding a Location Using the Search Bar

You can use the search bar to search for locations by entering a category, brand name, address, or city name.

- 1 Select **Where To?**.
- 2 Select **Search** in the search bar.
- 3 Enter all or part of the search term.
Suggested search terms appear below the search bar.
- 4 Select an option:
 - To search for a type of business, enter a category name (for example, "movie theaters").
 - To search for a business name, enter all or part of the name.
 - To search for an address near you, enter the house number and street name.
 - To search for an address in another city, enter the house number, street name, city, and state.
 - To search for a city, enter the city and state.
 - To search for coordinates, enter latitude and longitude coordinates.
- 5 Select an option:
 - To search using a suggested search term, select the term.
 - To search using the text you entered, select **Q**.
- 6 If necessary, select a location.

Finding an Address

NOTE: The order of the steps may change depending on the map data loaded on your device.

- 1 Select **Where To?**.
- 2 If necessary, select  to search near a different city or area.
- 3 Select **Address**.
- 4 Follow the on-screen instructions to enter address information.
- 5 Select the address.

Finding a Location by Category

- 1 Select **Where To?**.
- 2 Select a category, or select **Categories**.
- 3 If necessary, select a subcategory.
- 4 Select a location.

Searching Within a Category

After you have performed a search for a point of interest, certain categories may display a Quick Search list that shows the last four destinations you selected.

- 1 Select **Where To? > Categories**.
- 2 Select a category.
- 3 Select an option:
 - Select a destination from the quick search list on the right side of the screen.
The quick search list provides a list of recently found locations in the selected category.
 - Select a subcategory, if necessary, and select a destination.

Location Search Results

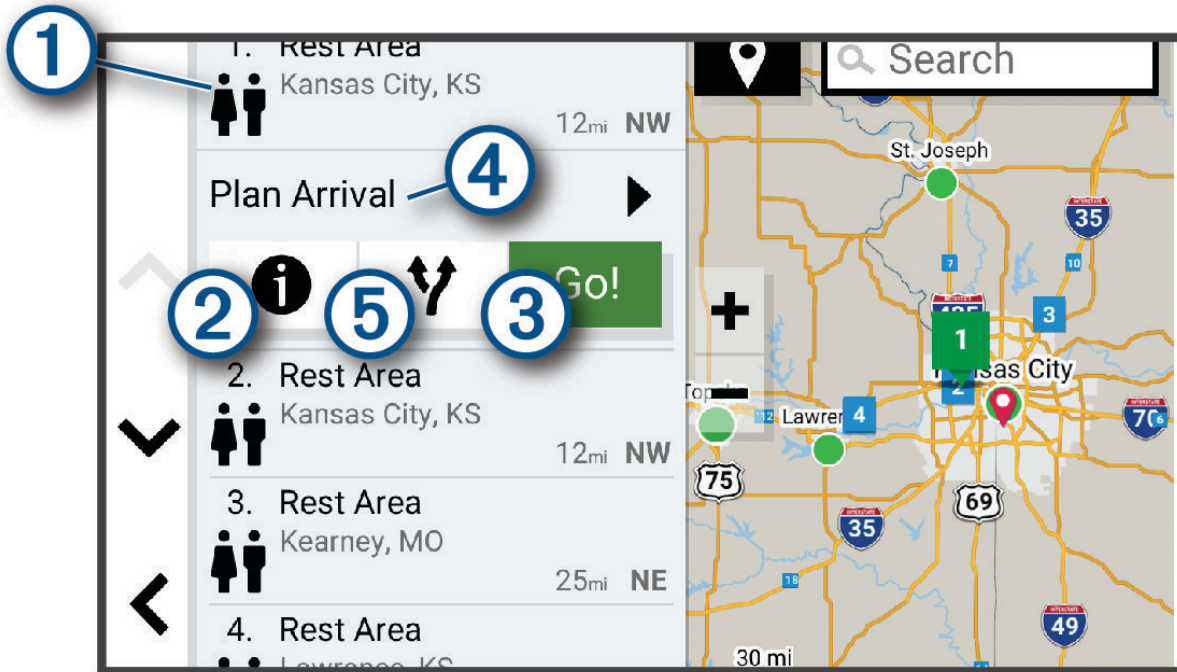

The location search results appear in a list, with the nearest location at the top. Each numbered location also appears on the map. You can scroll down to view more results.



①	Select a location to view the option menu.
② i	Select to view detailed information about the location.
③ Go!	Select to start navigating to the location using the recommended route.
④ Plan Arrival	Select to view a map of your destination and find a truck destination.
⑤ Y	Select to view alternate routes to the location.

Changing the Search Area

By default, the device searches for locations near your current location. You can also search other areas, such as near your destination, near another city, or along your active route.

- 1 Select **Where To?**.
- 2 Select  next to the current search area .

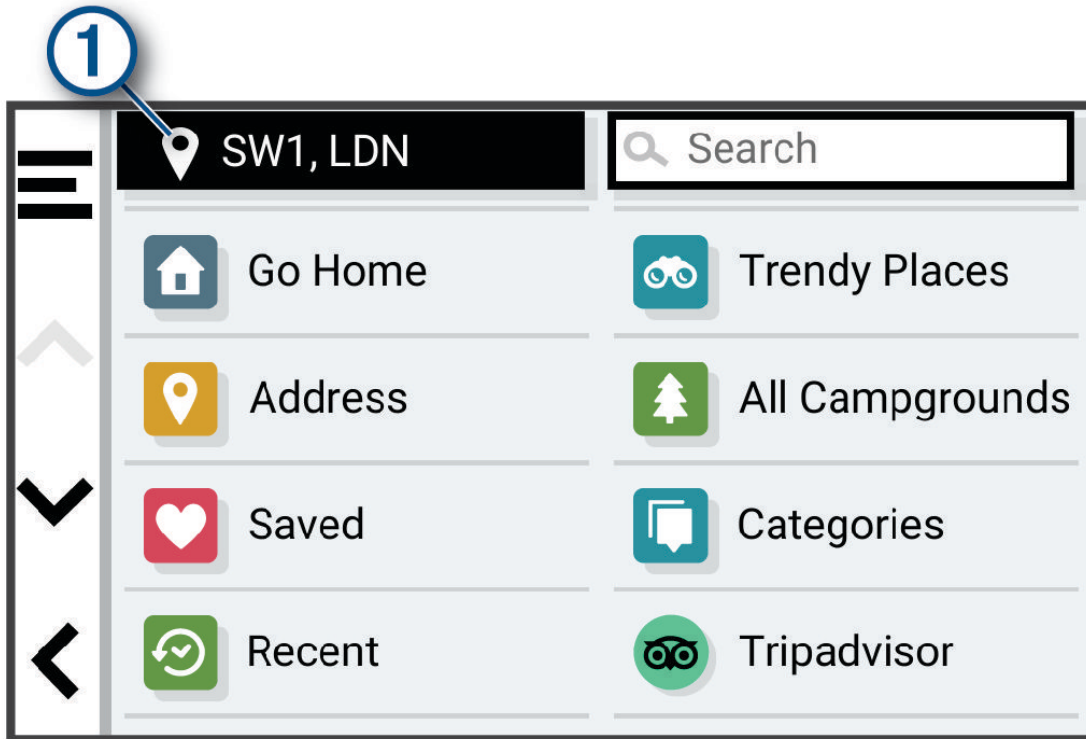

- 3 Select a search area.
- 4 If necessary, follow the on-screen instructions to select a specific location.

The selected search area appears next to . When you search for a location using any of the options in the Where To? menu, the device suggests locations near this area first.

Custom Points of Interest

Custom POIs are customized points on the map. They can contain alerts that let you know if you are near a designated point or if you are traveling faster than a specified speed.

Installing POI Loader

You can create or download custom POI lists on your computer and install them on your device using POI Loader software.

- 1 Go to www.garmin.com/poiloader.
- 2 Follow the on-screen instructions.

Finding Custom POIs

Before you can find custom POIs, you must load custom POIs on your device using the POI Loader software (*Installing POI Loader, page 15*).

- 1 Select **Where To? > Categories**.
- 2 Scroll to the Other Categories section, and select a category.

Parking

Finding Truck Parking

- 1 Select **Where To?** > **Categories** > **Trucking** > **Truck Parking**.
- 2 Select a parking location.
- 3 Select **Go!**.

Finding Truck Parking in Europe

- 1 Select **Where To?** > **Truck Parking Europe**.
- 2 If necessary, select **Filter by Amenities & Brands**, select one or more attributes, and select **Search**.
- 3 Select a parking location.
- 4 Select **Go!**.

Finding Parking Near Your Current Location

- 1 Select **Where To?** > **Categories** > **Parking**.
- 2 Select **Filter Parking**, and select one or more categories to filter parking by availability, type, price, or payment methods (optional).
NOTE: Detailed parking data is not available in all areas or for all parking locations.
- 3 Select a parking location.
- 4 Select **Go!**.

Search Tools

Search tools allow you to search for specific types of locations by responding to on-screen prompts.

Finding an Intersection

You can search for an intersection or junction between two streets, highways, or other roads.

- 1 Select **Where To?** > **Intersections**.
- 2 Follow the on-screen instructions to enter street information.
- 3 Select the intersection.

Finding a Location Using Coordinates

You can find a location using latitude and longitude coordinates. This can be helpful when geocaching.

- 1 Select **Where To?** > **Coordinates**.
- 2 If necessary, select  and change the coordinate format or datum.
- 3 Enter the latitude and longitude coordinates.
- 4 Select **View on Map**.

Tripadvisor

NOTICE

Garmin is not responsible for the accuracy or timeliness of the Tripadvisor information.

You are responsible for understanding and complying with any applicable rules, laws, or regulations associated with points of interest.

Your device includes Tripadvisor traveler ratings. Tripadvisor ratings appear automatically in the search results list for restaurants, hotels, and attractions. You can also search for nearby Tripadvisor points of interest and sort by distance or popularity.

Finding Tripadvisor Points of Interest

- 1 Select **Where To? > Tripadvisor**.
- 2 Select a category.
- 3 If necessary, select a subcategory.
A list of nearby Tripadvisor points of interest for the category appears.
- 4 Select **Sort Results** to filter the displayed points of interest by distance or popularity (optional).
- 5 Select , and enter a search term (optional).

Viewing Recently Found Locations

Your device stores a history of the last 50 locations you have found.

Select **Where To? > Recent**.

Clearing the List of Recently Found Locations

Select **Where To? > Recent >  > Clear > Yes**.

Viewing Current Location Information

You can use the *Where Am I?* page to view information about your current location. This feature is helpful if you need to tell emergency personnel your location.

From the map, select the vehicle.

Finding Emergency Services and Fuel

You can use the *Where Am I?* page to find the nearest hospitals, police stations, and fuel stations.

- 1 From the map, select the vehicle.
- 2 Select **Hospitals, Police Stations, Truck Stops, or Fuel**.
NOTE: Some service categories are not available in all areas.
NOTE: When a truck vehicle profile is active, an option for truck stops appears instead of fuel.
A list of locations for the selected service appears, with the nearest locations at the top.
- 3 Select a location.
- 4 Select an option:
 - To navigate to the location, select **Go!**.
 - To view the phone number and other location details, select .

Getting Directions to Your Current Location

If you need to tell another person how to get to your current location, your device can give you a list of directions.

- 1 From the map, select the vehicle.
- 2 Select  > **Directions to Me**.
- 3 Select a starting location.
- 4 Select **Select**.

Adding a Shortcut

You can add shortcuts to the *Where To?* menu. A shortcut can point to a location, a category, or a search tool. The *Where To?* menu can contain up to 36 shortcut icons.

- 1 Select **Where To? > Add Shortcut**.
- 2 Select an item.

Removing a Shortcut

- 1 Select **Where To?** >  > **Remove Shortcut(s)**.
- 2 Select a shortcut to remove.
- 3 Select the shortcut again to confirm.
- 4 Select **Done**.

Saving Locations



Saving a Location

- 1 Search for a location (*Finding a Location by Category*, page 13).
- 2 From the search results, select a location.
- 3 Select  > **Save**.
- 4 If necessary, enter a name, and select **Done**.
- 5 Select **Save**.

Saving Your Current Location

- 1 From the map, select the vehicle icon.
- 2 Select **Save**.
- 3 Enter a name, and select **Done**.



Editing a Saved Location

- 1 Select **Where To?** > **Saved**.
- 2 If necessary, select a category.
- 3 Select a location.
- 4 Select .
- 5 Select  > **Edit**.
- 6 Select an option:
 - Select **Name**.
 - Select **Phone Number**.
 - Select **Categories** to assign categories to the saved location.
 - Select **Change Map Symbol** to change the symbol used to mark the saved location on a map.
- 7 Edit the information.
- 8 Select **Done**.

Assigning Categories to a Saved Location

You can add custom categories to organize your saved locations.

NOTE: Categories appear in the saved locations menu after you have saved at least 12 locations.

- 1 Select **Where To?** > **Saved**.
- 2 Select a location.
- 3 Select .
- 4 Select  > **Edit** > **Categories**.
- 5 Enter one or more category names, separated by commas.
- 6 If necessary, select a suggested category.
- 7 Select **Done**.

Deleting a Saved Location

NOTE: Deleted locations cannot be recovered.

- 1 Select **Where To? > Saved**.
- 2 Select  > **Delete**.
- 3 Select the box next to the saved locations to delete, and select **Delete > Yes**.



Navigating to Your Destination

Routes

A route is a path from your current location to one or more destinations.

- The device calculates a recommended route to your destination based on the preferences you set, including the route calculation mode ([Changing the Route Calculation Mode, page 24](#)) and avoidances ([Avoiding Delays, Tolls, and Areas, page 25](#)).
- The device can automatically avoid roads that are not appropriate for the active vehicle profile.
- You can start navigating to your destination quickly using the recommended route, or you can select an alternate route ([Starting a Route, page 19](#)).
- If there are specific roads you need to use or avoid, you can customize the route ([Shaping Your Route, page 24](#)).
- You can add multiple destinations to a route ([Adding a Location to Your Route, page 24](#)).

Starting a Route

- 1 Select **Where To?**, and search for a location ([Finding and Saving Locations, page 12](#)).
- 2 Select a location.
- 3 Select an option:
 - To start navigating using the recommended route, select **Go!**.
 - To choose an alternate route, select , and select a route. Alternate routes appear to the right of the map.
 - To edit the course of the route, select  > **Edit Route**, and add shaping points to the route ([Shaping Your Route, page 24](#)).

The device calculates a route to the location and guides you using voice prompts and information on the map ([Your Route on the Map, page 20](#)). A preview of the major roads in your route appears at the edge of the map for several seconds.

If you need to stop at additional destinations, you can add the locations to your route ([Adding a Location to Your Route, page 24](#)).

Starting a Route by Using the Map

You can start route by selecting a location from the map.

- 1 Select **View Map**.
- 2 Drag and zoom the map to display the area to search.
- 3 Select a point, such as a street, intersection, or address location.
- 4 Select **Go!**.

Going Home

The first time you start a route home, the device prompts you to enter your home location.

- 1 Select **Where To? > Go Home**.
- 2 If necessary, enter your home location.

Editing Your Home Location

- 1 Select **Where To?** >  > **Set Home Location**.
- 2 Enter your home location.

Your Route on the Map

As you travel, the device guides you to your destination using voice prompts and information on the map. Instructions for your next turn or exit, or other actions appear across the top of the map.

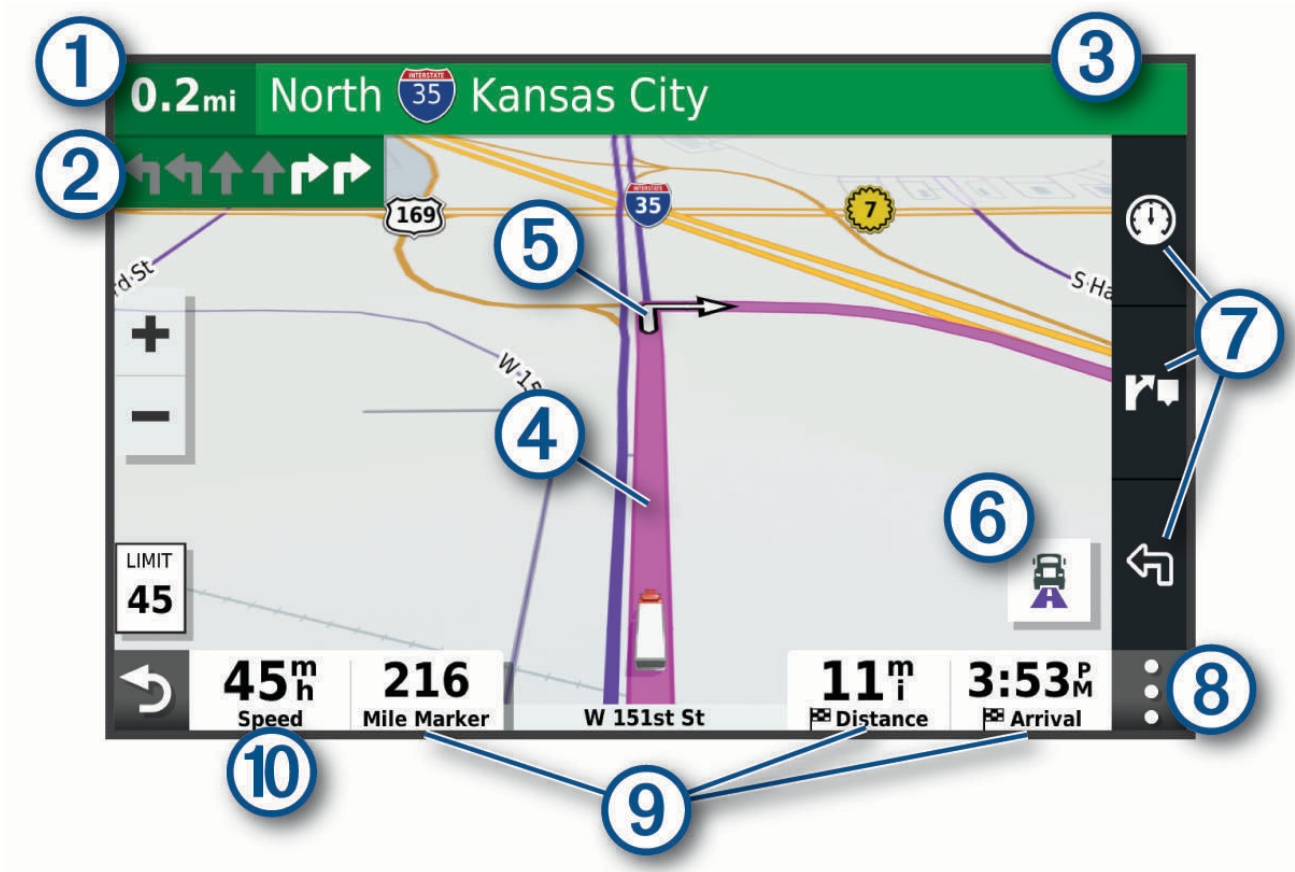

①	Distance to the next action.
②	Next action in the route. Indicates the next turn, exit, or other action and the lane in which you should travel, if available.
③	Name of the street or exit associated with the next action.
④	Route highlighted on the map.
⑤	Next action in the route. Arrows on the map indicate the location of upcoming actions.
⑥	Select to toggle popular truck routes on the map.
⑦	Map tool shortcuts.
⑧	Map tools. You can select the tools to show you more information about your route and surroundings.
⑨	Data fields. TIP: You can touch these fields to change the information they show (<i>Changing the Map Data Field</i> , page 31).
⑩	Vehicle speed.

Active Lane Guidance

As you approach some turns, exits, or interchanges in your route, a detailed simulation of the road appears beside the map, if available. A colored line ① indicates the proper lane for the turn.

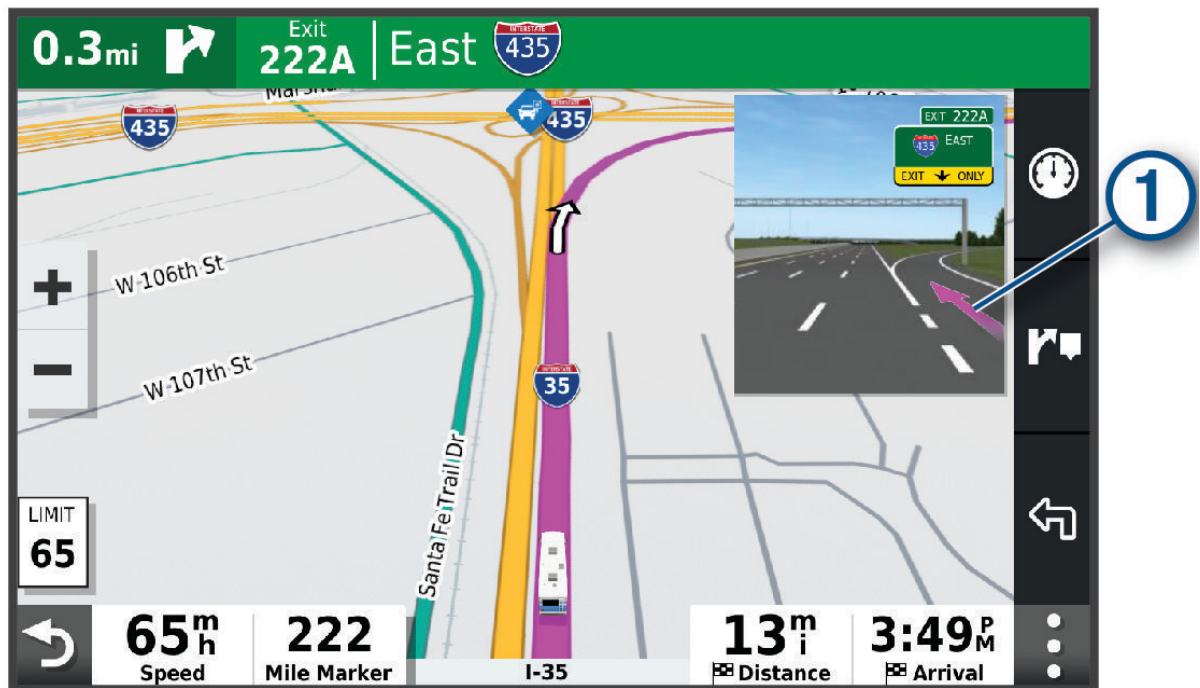

Viewing Popular Truck Paths on the Map

You can enable the device to highlight popular truck paths on the map. This can be useful to help you choose roads that are more accessible for your vehicle.

From the map, select .

Viewing Turns and Directions

While navigating a route, you can view upcoming turns, lane changes, or other directions for your route.

1 From the map, select an option:

- To view upcoming turns and directions as you navigate, select  > **Turns**.

The map tool displays the next several turns or directions beside the map. The list updates automatically as you navigate the route.

- To view the complete list of turns and directions for the entire route, select the text bar at the top of the map.

2 Select a turn or direction (optional).

Detailed information appears. An image of the junction may appear for junctions on major roadways, if available.

Viewing the Entire Route on the Map

1 While navigating a route, select anywhere on the map.

2 Select .

Planning Your Arrival

Before you start a route, you can plan to arrive at a popular truck destination, such as a loading dock or truck parking, at the end of your route. You can also add your own destinations to the map.

1 Select **Where To?**, and search for a location ([Finding and Saving Locations, page 12](#)).

2 Select a location.

3 Select **Plan Arrival**.

A preview of your destination appears on the map. Popular truck destinations appear next to the map. If your dēzl device is paired with the dēzl app, it downloads BirdsEye satellite imagery automatically.

4 Select a destination, and select **Go!**.

Arriving at Your Destination

When you approach your destination, the device provides information to help you complete your route.

-  indicates the location of your destination on the map, and a voice prompt announces you are approaching your destination.
- When you approach some destinations, the device automatically suggests parking areas. You can select **More** to view a full list of suggested parking areas ([Parking Near Your Destination, page 23](#)).
- When you approach some destinations while using a truck vehicle profile, the device automatically prompts you to find a truck destination such as a loading dock or truck parking. You can select a suggested point on the map, and then select **Go!** to navigate to that destination.
- When you stop at your destination, the device automatically ends the route. If the device does not detect your arrival automatically, you can select **Stop** to end your route.

Completing a Truck Route

When you approach some truck destinations, a map tool appears to help you find common truck destinations such as parking areas and loading docks.

- 1 Select the map tool ①.

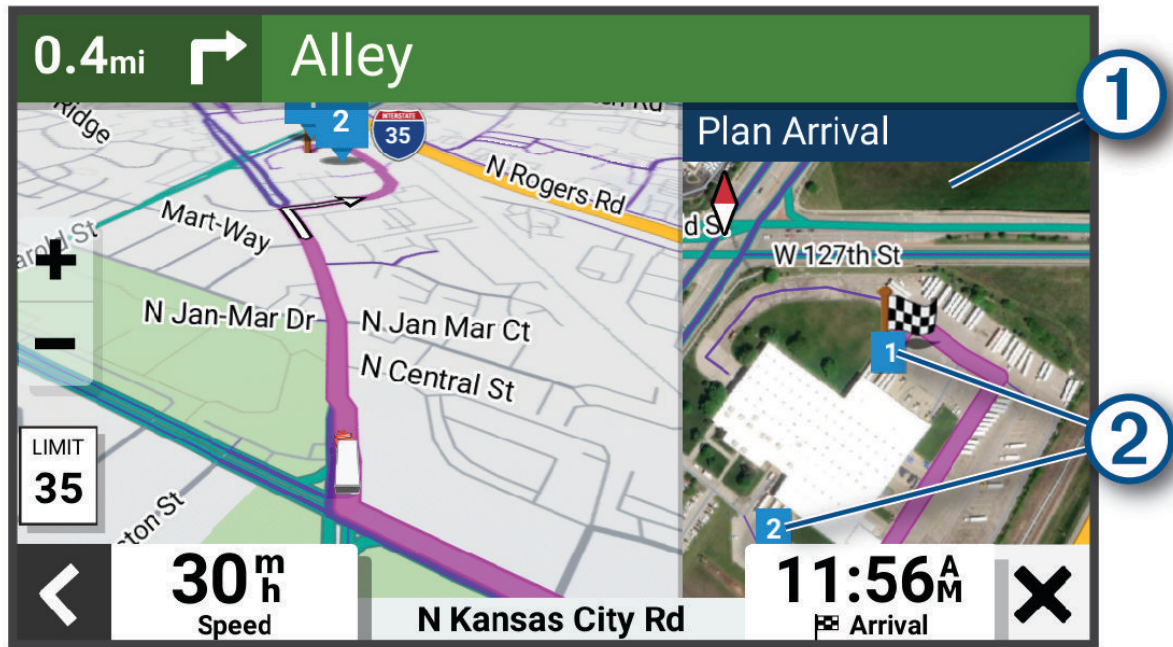

- 2 Touch the map, and select a numbered trucking destination ②.
- 3 Select **Go!**.

Parking Near Your Destination

Your device can help you find a parking spot near your destination. When you approach some destinations, the device automatically suggests parking areas.

NOTE: This feature should be used only when you are using the car vehicle profile. While using a truck vehicle profile, you can search for truck parking near your destination ([Finding Truck Parking, page 16](#)).

- 1 Select an option:
 - When the device suggests parking, select **More** to see all suggested parking areas.
NOTE: When you select a suggested parking area, the device automatically updates your route.
 - If the device does not suggest parking locations, select **Where To? > Categories > Parking**, and select > **My Destination**.
- 2 Select a parking location, and select **Go!**.
The device guides you to the parking area.

Changing Your Active Route

Adding a Location to Your Route

Before you can add a location to your route, you must be navigating a route (*Starting a Route, page 19*).

You can add locations to the middle or end of your route. For example, you can add a fuel station as the next destination in your route.

TIP: To create complex routes with multiple destinations or scheduled stops, you can use the trip planner to plan, schedule, and save a trip (*Planning a Route, page 53*).

- 1 From the map, select  > **Where To?**.
- 2 Search for a location (*Finding and Saving Locations, page 12*).
- 3 Select a location.
- 4 Select **Go!**.
- 5 Select an option:
 - To add the location as the next destination in your route, select **Add As Next Stop**.
 - To add the location to the end of your route, select **Add As Last Stop**.
 - To add the location and edit the order of destinations in your route, select **Add to Active Route**.

The device re-calculates the route to include the added location and guides you to the destinations in order.



Shaping Your Route

Before you can shape your route, you must start a route (*Starting a Route, page 19*).

You can manually shape your route to change its course. This allows you to direct the route to use a certain road or go through a certain area without adding a destination to the route.

- 1 From the map, select  > **Edit Route** > **Shape Route**.

TIP: You can select  to zoom in on the map and select a more precise location.

The device enters route shaping mode and recalculates the route to travel through the selected location.
- 2 Select  > .
- 3 If necessary, select an option:
 - To add more shaping points to the route, select additional locations on the map.
 - To remove a shaping point, select the shaping point and select .

Taking a Detour

You can take a detour for a specified distance along your route or detour around specific roads. This is useful if you encounter construction zones, closed roads, or poor road conditions.

- 1 From the map, select  > **Edit Route**.
- 2 Select an option:
 - To detour your route for a specific distance, select **Detour by Distance**.
 - To detour around a specific road on the route, select **Detour by Road**.

Changing the Route Calculation Mode

- 1 Select **Settings** > **Navigation** > **Calculation Mode**.
- 2 Select an option:
 - Select **Faster Time** to calculate routes that are faster to drive but can be longer in distance.
 - Select **Shorter Distance** to calculate routes that are shorter in distance but can take more time to drive.

Stopping the Route

- From the map, select  > **Stop**.
- From the home screen, select **Stop**.

Using Suggested Routes

Before you can use this feature, you must save at least one location and enable the travel history feature ([Navigation Settings, page 59](#)).

Using the myTrends™ feature, your device predicts your destination based on your travel history, the day of the week, and the time of day. After you have driven to a saved location several times, the location may appear in the navigation bar on the map, along with the estimated time of travel, and traffic information.

Select the navigation bar to view a suggested route to the location.

Avoiding Delays, Tolls, and Areas

Avoiding Traffic Delays on Your Route

Before you can avoid traffic delays, you must be receiving traffic information ([Receiving Traffic Data Using Your Smartphone, page 35](#)).

By default, the device optimizes your route to avoid traffic delays automatically. If you have disabled this option in the traffic settings ([Traffic Settings, page 60](#)), you can view and avoid traffic delays manually.

- 1 While navigating a route, select  > **Traffic**.
- 2 Select **Alternate Route**, if available.
- 3 Select **Go!**.

Avoiding Road Features

- 1 Select **Settings** > **Navigation** > **Avoidances**.
- 2 Select the road features to avoid on your routes, and select **OK**.

Avoiding Environmental Zones

Your device can avoid areas with environmental or emissions restrictions that may apply to your vehicle. This option applies to the vehicle type in the active vehicle profile ([Vehicle Profiles, page 9](#)).

- 1 Select **Settings** > **Navigation** > **Environmental Zones**.
- 2 Select an option:
 - To be asked each time before routing through an environmental zone, select **Always Ask**.
 - To always avoid environmental zones, select **Avoid**.
 - To always allow environmental zones, select **Allow**.

Custom Avoidances

Custom avoidances allow you to select specific areas or sections of road to avoid. When the device calculates a route, it avoids these areas and roads unless no other reasonable route is available.

Avoiding a Road

- 1 Select **Settings** > **Navigation** > **Custom Avoidances**.
- 2 If necessary, select **Add Avoidance**.
- 3 Select **Add Avoid Road**.
- 4 Select the starting point of the section of road to avoid, and select **Next**.
- 5 Select the ending point of the road section, and select **Next**.
- 6 Select **Done**.

Avoiding an Area

- 1 Select **Settings** > **Navigation** > **Custom Avoidances**.
- 2 If necessary, select **Add Avoidance**.
- 3 Select **Add Avoid Area**.
- 4 Select the upper-left corner of the area to avoid, and select **Next**.
- 5 Select the lower-right corner of the area to avoid, and select **Next**.
The selected area is shaded on the map.
- 6 Select **Done**.

Disabling a Custom Avoidance

You can disable a custom avoidance without deleting it.





- 1 Select **Settings** > **Navigation** > **Custom Avoidances**.
- 2 Select an avoidance.
- 3 Select  > **Disable**.

Deleting Custom Avoidances

- 1 Select **Settings** > **Navigation** > **Custom Avoidances** > .
- 2 Select an option:
 - To delete all custom avoidances, select **Select All** > **Delete**.
 - To delete one custom avoidance, select the avoidance, and select **Delete**.

Using the Map

You can use the map to navigate a route ([Your Route on the Map, page 20](#)) or to view a map of your surroundings when no route is active.

- 1 Select **View Map**.
- 2 Touch anywhere on the map.
- 3 Select an option:
 - Drag the map to pan left, right, up, or down.
 - To add or remove map layers such as topographic and BirdsEye imagery, select .
 - To zoom in or out, select  or .
 - To switch between North Up, 2-D, and 3-D views, select .
 - To open the route planner, select  ([Route Planner, page 53](#)).
 - To start a route, select a location on the map, and select **Go!** ([Starting a Route by Using the Map, page 19](#)).

Map Tools

Map tools provide quick access to information and device functions while you view the map. When you activate a map tool, it appears in a panel at the edge of the map.

Stop: Stops navigation of the active route.

Edit Route: Allows you to take a detour or skip locations in your route ([Changing Your Active Route, page 24](#)).

Mute: Mutes the device audio.

Cities Ahead: Shows upcoming cities and services along your active route or along a highway ([Cities Ahead, page 28](#)).

Up Ahead: Shows upcoming locations along the route or the road on which you are traveling ([Up Ahead, page 27](#)).

Elevation: Displays elevation changes ahead.

Traffic: Displays traffic conditions along your route or in your area ([Viewing Upcoming Traffic, page 30](#)). This feature is not available in all areas or for all device models.

Trip Data: Displays customizable trip data, such as speed or mileage ([Viewing Trip Data from the Map, page 30](#)).

Turns: Displays a list of upcoming turns in your route ([Viewing Turns and Directions, page 22](#)).

Phone: Displays a list of recent phone calls from your connected phone, and displays in-call options while a phone call is active ([Using In-Call Options, page 34](#)).

Weather: Displays weather conditions for your area.

photoLive: Displays live traffic cameras from your photoLive subscription ([photoLive Traffic Cameras, page 35](#)).

Garmin eLog: Displays hours of service information from the Garmin eLog™ app. Allows you to change duty status while you are not driving.

Smart Notifications: Displays recent smart notifications from your connected phone ([Smart Notifications, page 33](#)).

PrePass®: Shows notifications for upcoming weigh stations and bypass decisions ([PrePass®, page 40](#)).

Plan Arrival: Shows a map of your destination and allows you to find a truck destination.



Love's: Shows upcoming Love's Travel Stops® along your route.

Pilot Flying J: Shows upcoming Pilot Flying J Travel Centers™ along your route.

Break Planner: Displays break reminders and suggested stops.

Overview Map: Shows an overview of your route on the map.

Viewing a Map Tool

- 1 From the map, select .
- 2 Select a map tool.
The map tool appears in a panel at the edge of the map.
- 3 When you are done using the map tool, select .

Up Ahead

The Up Ahead tool provides information about upcoming locations along your route or the road on which you are traveling. You can view upcoming points of interest by category, such as restaurants, fuel stations, or rest areas.

You can customize the categories that show in the Up Ahead tool.

Viewing Upcoming Locations

- 1 From the map, select  > **Up Ahead**.

While you are traveling, the map tool shows the next location along your road or route.

- 2 Select an option:

- If the map tool shows categories, select a category to view a list of nearby locations in that category.
- If the map tool shows upcoming locations, select a location to view location details or start a route to the location.

Customizing the Up Ahead Categories

You can change the location categories that appear in the Up Ahead tool.

- 1 From the map, select  > **Up Ahead**.

- 2 Select a category.

- 3 Select .

- 4 Select an option:

- To move a category up or down in the list, select and drag the arrow next to the category name.
- To change a category, select the category.
- To create a custom category, select a category, select **Custom Search**, and enter the name of a business or category.

- 5 Select **Save**.

Cities Ahead

While you are traveling on a highway or navigating a route that includes a highway, the Cities Ahead tool provides information about upcoming cities along the highway. For each city, the map tool shows the distance to the highway exit and the services available, similar to the information on highway road signs.

Viewing Upcoming Cities and Exit Services

- 1 From the map, select  > **Cities Ahead**.

While you are traveling along a highway or an active route, the map tool shows information about upcoming cities and exits.

- 2 Select a city.

The device shows a list of points of interest located at the selected city exit, such as fuel stations, lodging, or restaurants.

- 3 Select a location, and select **Go!** to start navigating.

Warning and Alert Symbols

WARNING



Entering your vehicle profile characteristics does not guarantee that your vehicle's characteristics will be accounted for in all route suggestions or that you will receive the warning icons in all cases. Limitations may exist in the map data such that your device cannot account for these restrictions or road conditions in all cases. Always defer to all posted road signs and road conditions when making driving decisions.

Warning and alert symbols may appear on the map or in route directions to alert you to potential hazards, road conditions, and upcoming weigh stations.



Restriction Warnings

	Height
	Weight
	Axle Weight
	Length
	Width
	No Trucks Allowed
	No Trailers Allowed
	Material Restrictions
	No Flammables or Explosives Allowed
	No Water Pollutants Allowed
	No Left Turn
	No Right Turn
	No U Turn

Road Condition Warnings

	Risk of grounding
	Lateral wind
	Narrow road
	Sharp curve
	Steep down hill
	Steep up hill
	Tree overhang

Alerts

	Weigh station
	Road not verified for trucks

Trip Information

Viewing Trip Data from the Map

From the map, select  > **Trip Data**.

Customizing the Trip Data Fields

- 1 From the map, select  > **Trip Data**.
- 2 Select a trip data field.
- 3 Select an option.

The new trip data field appears in the trip data map tool.

Viewing Your Trip History

Your device keeps a record of the path you have traveled.

- 1 Select **Settings** > **Map Display** > **Map Layers**.
- 2 Select the **Trip History** check box.

Resetting Trip Information

- 1 From the map, select **Speed**.
- 2 Select a trip information data field.
- 3 Select  > **Reset Field(s)**.
- 4 Select an option:
 - When not navigating a route, select **Select All** to reset every data field except the speedometer, on the first page.
 - Select **Reset Overall Data** to reset Trip A and total data.
 - Select **Reset Max. Speed** to reset the maximum speed.
 - Select **Reset Trip B** to reset the odometer.

Viewing Upcoming Traffic

NOTICE

Garmin is not responsible for the accuracy or timeliness of the traffic information.

Before you can use this feature, your device must be receiving traffic data ([Traffic](#), page 35).

You can view traffic incidents coming up along your route or along the road on which you are traveling.



- 1 While navigating a route, select  > **Traffic**.

The nearest upcoming traffic incident appears in a panel on the right side of the map.



- 2 Select the traffic incident to view additional details.

Viewing Traffic on the Map

The traffic map shows color-coded traffic flow and delays on nearby roads.

- 1 From the main menu, select  > **dēzl** > **Traffic**.
- 2 If necessary, select  > **Legend** to view the legend for the traffic map.

Searching for Traffic Incidents

- 1 From the main menu, select  > **dēzl** > **Traffic**.
- 2 Select  > **Incidents**.
- 3 Select an item in the list.
- 4 If there is more than one incident, use the arrows to view additional incidents.

Customizing the Map

Customizing the Map Layers

You can customize which data appear on the map, such as icons for points of interest and road conditions.

- 1 Select **Settings** > **Map Display** > **Map Layers**.
- 2 Select the layers to include on the map, and select **Save**.

Changing the Map Data Field

- 1 From the map, select a data field.
NOTE: You cannot customize Speed.
- 2 Select a type of data to display.

Changing the Map Perspective

- 1 Select **Settings** > **Map Display** > **Driving Map View**.
- 2 Select an option:
 - Select **Track Up** to display the map in two dimensions (2-D), with your direction of travel at the top.
 - Select **North Up** to display the map in 2-D with north at the top.
 - Select **3-D** to display the map in three dimensions.
- 3 Select **Save**.

Live Services, Traffic, and Smartphone Features

WARNING

Do not read or interact with notifications while driving, because doing so can cause distraction that could lead to an accident resulting in serious personal injury or death.

The dēzl app allows your device to receive smart notifications and live information, such as live traffic data and weather information.

Live traffic data: Sends real-time traffic data to your device, such as traffic incidents and delays, construction zones, and road closings ([Traffic, page 35](#)).

Weather information: Sends real-time weather forecasts, road conditions, and weather radar to your device ([Viewing the Weather Forecast, page 54](#)).

Smart Notifications: Displays phone notifications and messages on your device. This feature is not available for all languages.

Hands-Free calling: Allows you to place and receive phone calls using your device, and allows you to use the device as a hands-free speaker phone. If the selected language supports the voice command feature, you can place calls using voice commands.

Send locations to device: Allows you to send locations from your smartphone to your navigation device.

Pairing with Your Smartphone

You can pair your dēzl device with your smartphone and the dēzl app to enable additional features and access live information ([Live Services, Traffic, and Smartphone Features, page 31](#)).

- 1 From the app store on your smartphone, install the dēzl app.
- 2 Turn on your dēzl device, and place the device and your smartphone within 3 m (10 ft.) of each other.
- 3 On your phone, open the dēzl app.
- 4 Follow the on-screen instructions to sign in to a Garmin account and complete the pairing and setup process.

The main app dashboard appears. After the devices are paired, they connect automatically when they are turned on and within range.

Tips After Pairing the Devices

- After the initial pairing, the two devices can connect automatically each time you turn them on.
- When your phone is connected to your device, you are ready to receive voice calls.
- When you turn on the device, it tries to connect to the last phone to which it was connected.
- You might need to set your phone to connect to the device automatically when the device is turned on.
- To place phone calls, the contact sharing permission must be enabled for the navigation device in the Bluetooth settings on your phone.
- You should verify the Bluetooth features you want to use are enabled ([Enabling or Disabling Bluetooth Features, page 34](#)).

Pairing Additional Bluetooth Devices

- 1 Place your headset or phone and your Bluetooth device within 33 ft. (10 m) of each other.
- 2 On your device, enable Bluetooth wireless technology.
- 3 On your headset or phone, enable Bluetooth wireless technology and ensure it is visible to other Bluetooth devices.
- 4 On your device, select **Settings > Wireless Networks > Bluetooth**.
A list of nearby Bluetooth devices appears.
- 5 Select your headset or phone from the list.
- 6 If necessary, select **Pair**.

Going to an Address or Location Using the dēzl App

You can use the dēzl app to search for an address, business, or point of interest, and send it to your dēzl device for navigation.

- 1 From the dēzl app, select **Where To?**
- 2 Select an option:
 - To search for an address near you, enter the house number and street name.
 - To search for an address in another city, enter the house number, street name, city, and state.
 - To search for a business name, enter all or part of the name.
 - To search for a city, enter the city and state.

As you type, suggestions appear below the search field.

- 3 Select a suggested search result.
The app displays the location on a map.
- 4 Select **Go!** to start a route.

The dēzl device starts navigating to the selected location, and the location is added to your recent searches in the Where To? menu.

Smart Notifications

While your device is connected to the dēzl app, you can view notifications from your smartphone on your dēzl device, such as text messages, incoming calls, and calendar appointments.

Receiving Notifications

WARNING

Do not read or interact with notifications while driving, because doing so can cause distraction that could lead to an accident resulting in serious personal injury or death.

Before you can use this feature, your device must be connected to a supported phone running the dēzl app.

From most pages, a popup appears when the device receives a notification from your smartphone. If the device is moving, you must verify you are a passenger and not the driver before you can view notifications.

NOTE: If you are viewing the map, notifications appear in a map tool.

- To ignore a notification, select **OK**.
The popup closes, but the notification remains active on your phone.
- To view a notification, select **View**.
- To listen to the notification, select **View > Play**.
The device reads the notification using text-to-speech technology. This feature is not available for all languages.
- To perform additional actions, such as dismissing the notification from your phone, select **View**, and select an option.





NOTE: Additional actions are available for only some notification types and must be supported by the app generating the notification.

Hands-Free Calling

NOTE: While most phones and headsets are supported and can be used, a particular phone or headset cannot be guaranteed to be compatible. All features may not be available for your phone.

Using Bluetooth wireless technology, your device can connect to your compatible mobile phone and wireless headset or helmet to become a hands-free device. To check compatibility, go to www.garmin.com/bluetooth.

Placing a Call

- 1 Select .
- 2 Select an option:
 - To dial a number, select , enter the phone number, and select .
 - To call a recently dialed or received phone number, select , and select a number.
 - To call a contact from your phone book, select , and select a contact.



Receiving a Call

When you receive a call, select **Answer** or **Dismiss**.

Using In-Call Options

In-call options appear when you answer a call. Some options may not be compatible with your phone.



TIP: If you close the in-call options page, you can open it again by selecting  from the main menu.

- To set up a conference call, select the caller ID, and select .
- To transfer audio to your phone, select .

TIP: You can use this feature if you want to disconnect the Bluetooth connection and remain on the call, or if you need privacy.



- To use the dial pad, select the caller ID, and select .

TIP: You can use this feature to use automated systems, such as voice mail.

- To mute the microphone, select .
- To hang up, select .

Saving a Phone Number as a Preset

You can save up to three contacts as presets on the dial pad. This allows you to quickly call your home phone number, family members, or frequently called contacts.

- 1 Select  > .
- 2 Hold a preset number, such as **Preset 1**.
- 3 Select a contact.

Wireless Headsets

Your device can send audio navigation prompts to a Bluetooth enabled wireless headset.

Enabling or Disabling Bluetooth Features

You can enable or disable Bluetooth features such as phone calls, media audio, and live services for your paired smartphone.

- 1 Select **Settings** > **Wireless Networks** > **Bluetooth**.
- 2 Select your phone name.
- 3 Select a feature to enable or disable it.



Showing or Hiding App Notifications (Android™)

You can use the dēzl app to customize which types of smartphone notifications appear on your dēzl device.

- 1 On your phone, open the dēzl app.
- 2 Select  > **Smart Notifications**.
A list of smartphone app categories appears.
- 3 Select a category to enable or disable notifications for that type of app.

Showing or Hiding Notification Categories for Your Apple® Device

If you are connected to an Apple device, you can filter the notifications shown on your dēzl device by showing or hiding categories.

- 1 Select  > **Tools** > **Smart Notifications** > .
- 2 Select the check box next to each notification to show.

Disconnecting a Bluetooth Device

You can temporarily disconnect a Bluetooth device without deleting it from the paired devices list. The Bluetooth device can connect to your dēzl device automatically in the future.

- 1 Select **Settings** > **Wireless Networks** > **Bluetooth**.
- 2 Select the device to disconnect.
- 3 Select **OK**.

Deleting a Paired Bluetooth Device

You can delete a paired Bluetooth device to prevent it from automatically connecting to your dēzl device in the future. Deleting a paired smartphone also deletes all synced phonebook contacts and call history from your dēzl device.

- 1 Select **Settings** > **Bluetooth**.
- 2 Next to the Bluetooth device name, select  > **Forget**.

Deleting a Paired Phone

You can delete a paired phone to prevent it from automatically connecting to your device in the future.

- 1 Select **Settings** > **Bluetooth** > **Bluetooth**.
- 2 Select the phone, and select **Forget**.

Traffic

NOTICE

Garmin is not responsible for the accuracy or timeliness of the traffic information.

Your device can provide information about traffic on the road ahead or on your route. You can set your device to avoid traffic when calculating routes, and to find a new route to your destination if a large traffic delay occurs on your active route ([Traffic Settings, page 60](#)). The traffic map allows you to browse the map for traffic delays in your area.

To provide traffic information, your device must be receiving traffic data.

- All product models can receive subscription-free traffic data using the dēzl app ([Receiving Traffic Data Using Your Smartphone, page 35](#)).

Traffic data is not available in all areas. For information about traffic coverage areas, go to garmin.com/traffic.

Receiving Traffic Data Using Your Smartphone

Your device can receive subscription-free traffic data while connected to a smartphone running the dēzl app.



- 1 Connect your device to the dēzl app.
- 2 On your dēzl device, select **Settings** > **Traffic** > **Traffic**, and verify the **Garmin Live Traffic** option is selected.

Viewing Traffic on the Map

The traffic map shows color-coded traffic flow and delays on nearby roads.

- 1 From the main menu, select  > **dēzl** > **Traffic**.
- 2 If necessary, select  > **Legend** to view the legend for the traffic map.

Searching for Traffic Incidents

- 1 From the main menu, select  > **dēzl** > **Traffic**.
- 2 Select  > **Incidents**.
- 3 Select an item in the list.
- 4 If there is more than one incident, use the arrows to view additional incidents.

photoLive Traffic Cameras

Before you can use this feature, your device must be connected to the dēzl app ([Pairing with Your Smartphone, page 32](#)).

photoLive traffic cameras provide live images of traffic conditions on major roadways and intersections.

The photoLive service is not available in all areas.

Viewing and Saving photoLive Traffic Cameras

You can view live images from nearby traffic cameras. You can also save traffic cameras for areas you travel frequently.

1 Select  > **photoLive**.

2 Select **Touch to Add**

3 Select a road.

4 Select a traffic camera location.

A preview of the live image from the camera appears next to a map of the camera's location. You can select the image preview to view the full-sized image.

5 Select **Save** to save the camera (optional).

A thumbnail image preview of the camera is added to the main screen of the photoLive app.

Saving a Traffic Camera

1 Select  > **photoLive**.

2 Select **Touch to Add**.

3 Select a traffic camera.

4 Select **Save**.

Vehicle and Driver Tools

Break Planning

NOTICE

This device by itself is NOT an approved substitute for logbook recording requirements under Federal Motor Carrier Safety Administration (FMCSA) regulations. Drivers should comply with all applicable federal and state hours-of-service requirements. When integrated with a Garmin eLog compliant Electronic Logging Device (ELD), this device enables a motor carrier to comply with hours of service logging and break requirements. For more information, or to purchase a Garmin eLog device, go to garmin.com/elog.

When the break planning feature is enabled, the device notifies you one hour before suggested break times and drive hour limits and suggests break locations on your route. You can use this feature to keep track of your working hours, which may help you comply with safety regulations.

NOTE: Break planning features are not available when using the car vehicle profile.

Taking a Suggested Break

When it is time for a break, the device notifies you and displays suggested break location POIs along your route.

Select a POI from the list of suggested break locations.

The device adds the break location as the next destination on your route.

Starting the Break Timer

The break timer starts automatically when the vehicle is moving at least 8 kph (5 mph) for 30 seconds. You can start the timer manually at any time.

1 From the map, select  > **Break Planner**.

2 Select **Start Timer**.

Pausing and Resetting the Break Timer

The break timer pauses automatically when the vehicle stops for three minutes or longer. You can pause the timer manually for brief stops, such as parking or stopping at a truck stop. At the end of your drive, you can manually reset the timer.

- 1 Select **Stop Timer**.
- 2 Select an option:
 - To pause the timer, select **Pause**.
 - To stop and reset the timer, select **Reset**.

Adjusting Drive Hours

You can adjust your total hours driven to more closely match your hours of service records.

- 1 While using the break planner feature, select **Total Hours Driven**.
- 2 Enter the total hours driven.
- 3 Select **Save**.

Adjusting the Daily Driving Limit

You can adjust the daily driving limit to correspond with legal requirements in your area.

NOTE: This feature is not available in all areas.

- 1 While using the break planner feature, select **Daily Hours Driven**.
- 2 Select the daily driving limit for your area.
- 3 Select **Save**.

IFTA

NOTE: This feature is not available in all areas.



Before you can use this feature, a truck vehicle profile must be active.

You can record data needed for International Fuel Tax Agreement documentation (IFTA), such as fuel-purchase data and miles driven.

Entering Fuel Data



- 1 Select  > **dēzl** > **IFTA** > **At the Pump**.
- 2 Enter the fuel price per gallon.
- 3 Select the **Fuel Used** field.
- 4 Enter the amount of fuel purchased.
- 5 If necessary, select the fuel type:
 - To record the amount in liters, select **Gallons** > **Liters** > **Save**.
 - To record the amount in gallons, select **Liters** > **Gallons** > **Save**.
- 6 If necessary, select the **Tax Included** check box.
- 7 Select **Next**.
- 8 Select an option to record the fuel station where you refueled:
 - Select a nearby fuel station from the list.
 - Select the text field, and enter the fuel station name and address.
- 9 Select the fuel purchaser.

Editing Fuel Data





- 1 Select  > **dēzl** > **IFTA** > **Fuel Journals**.
- 2 If necessary, select a vehicle profile.
- 3 If necessary, select a quarter.
- 4 Select a fuel record.
- 5 Select an option:
 - Select a field to edit the information.
 - Select  to delete the record.

Viewing and Exporting a Jurisdiction Summary

The jurisdiction summary lists data for each state or province in which your vehicle has operated during each quarter. The jurisdiction summary is available in some areas.

- 1 Select  > **dēzl** > **IFTA** > **Jurisdiction Summary**.
- 2 If necessary, select a truck.
- 3 If necessary, select a quarter.
- 4 Select  > **Export** > **OK** to export a jurisdiction summary.
The device exports the summary to a .csv file and stores it in the Reports folder on the device.

Editing and Exporting Trip Reports

- 1 From the main menu, select  > **dēzl** > **IFTA** > **Trip Reports**.
- 2 If necessary, select a truck.
- 3 If necessary, select a quarter.
- 4 Select a report.
- 5 Select an option:
 - Select  > **Delete**, and select the check box to delete a report.
 - Select  > **Combine**, and select the check boxes to combine reports.
 - Select  > **Export** > **OK**. The device exports the report to a .csv file and stores it in the **Reports** folder on the device.

Viewing Exported Jurisdiction Summaries and Trip Reports

NOTICE

If you do not know the purpose of a file, do not delete it. Your device memory contains important system files that should not be deleted.



- 1 Connect the device to your computer.
- 2 From the file browser on your computer, browse to the internal device storage, and open the **Reports** folder.
- 3 Open the **IFTA** folder.
- 4 Open the .csv file.

Logging Service History

You can log the date and odometer reading when service or maintenance is performed on your vehicle. The device provides several service categories, and you can add custom categories ([Adding Service Categories, page 39](#)).



- 1 Select  > **Tools** > **Service History**.
- 2 Select a service category.
- 3 Select **Add Record**.
- 4 Enter the odometer reading, and select **Next**.
- 5 Enter a comment (optional).
- 6 Select **Done**.

Adding Service Categories



- 1 Select  > **Tools** > **Service History**.
- 2 Select  > **Add Category**.
- 3 Enter a category name, and select **Done**.

Deleting Service Categories



When you delete a service category, all service records in the category are also deleted.

- 1 Select  > **Tools** > **Service History**.
- 2 Select  > **Delete Categories**.
- 3 Select the service categories to delete.
- 4 Select **Delete**.

Renaming Service Categories

- 1 Select  > **Tools** > **Service History**.
- 2 Select the category to be renamed.
- 3 Select  > **Rename Category**.
- 4 Enter a name, and select **Done**.

Deleting Service Records

- 1 Select  > **Tools** > **Service History**.
- 2 Select a service category.
- 3 Select  > **Delete Records**.
- 4 Select the service records to be deleted.
- 5 Select **Delete**.

Editing a Service Record

You can edit the comment, odometer reading, and date of a service record.

- 1 Select  > **Tools** > **Service History**.
- 2 Select a category.
- 3 Select a field.
- 4 Enter the new information, and select **Done**.

NOTICE

Garmin is not responsible for the accuracy or timeliness of the information provided by the PrePass app.

NOTE: Before you can use this feature, you must have an active PrePass account.

The PrePass app enables drivers to verify the safety, credentials, and weight of a commercial vehicle with upcoming weigh stations. You can pair your dēzl device with the dēzl app and the PrePass app to receive upcoming weigh station notifications on your dēzl device.

NOTE: This feature is available only in the United States.

Loyalty Programs

From your dēzl device, you can access loyalty programs from some of the travel plazas in the United States, including Love's Travel Stops and Pilot Flying J Travel Centers. You can use the loyalty program apps on your dēzl device to check reward points balances and other loyalty program information. To activate loyalty program features, sign in to your loyalty program account in the dēzl app.

NOTE: This feature is available only in the United States.

Garmin eLog

The Garmin eLog adapter enables a motor carrier to comply with FMCSA Electronic Logging Device (ELD) regulations. When the dēzl device is paired with the Garmin eLog adapter, the dēzl device and the Garmin eLog adapter together provide a complete ELD solution without the need for an additional smartphone or mobile device. You can use your dēzl device to record and view hours of service information, change your duty status, create inspection reports, and more.

The Garmin eLog adapter is not available in all areas. For more information, or to purchase a Garmin eLog adapter, go to garmin.com/elog.

Setting Up Your Garmin eLog Adapter

NOTE: If you need to transfer Garmin eLog data from another device to your dēzl device, you must import the data during the setup process. You should create a data backup from your previous device before you start setting up the Garmin eLog adapter on your dēzl device (*Transferring Garmin eLog Data from Another Device*, page 40).

You must set up and pair your Garmin eLog adapter with the Garmin eLog app in order to be in compliance with FMCSA ELD regulations. For more information about installing the Garmin eLog adapter in your vehicle, see the *Garmin eLog Owner's Manual* at garmin.com/manuals/elog.

- 1 On your dēzl device, open the  Garmin eLog app.
- 2 Follow the instructions in the app to set up and configure the Garmin eLog system, administrator account, and driver profiles.

NOTICE

The administrator account is critical for some app functions. Choose an administrator password you can remember, and do not lose the password. The administrator password cannot be recovered without clearing all app data, which causes all recorded Garmin eLog data to be deleted.

NOTE: Until you complete the setup process, the Garmin eLog device has limited functionality and is not compliant with FMCSA ELD regulations.

Transferring Garmin eLog Data from Another Device

If you have previously used your Garmin eLog adapter with another device, you can transfer the Garmin eLog app data from the previous device to your dēzl device. You must complete this transfer during the initial setup.

- 1 From the Garmin eLog app on your previous device, create a data backup (*Backing Up Data*, page 41).
- 2 While setting up your Garmin eLog adapter with your dēzl device, restore the data backup (*Restoring Data*, page 41).

Backing Up Data

You can back up your recorded data to a USB storage device. You should back up regularly to help prevent data loss. This is also useful when you need to transfer data to another device.

- 1 From the Garmin eLog app, select **Settings > Back Up Data**.
- 2 Insert a USB storage device into the USB port on the Garmin eLog adapter.
The light ring on the adapter glows green and plays a tone when it is ready to back up data.
- 3 Select **Back Up Data**.

Restoring Data

You can restore backed up data from a USB storage device. This can be useful when transferring Garmin eLog app data from another device.

NOTE: You can restore backed up data only while you are setting up the Garmin eLog app.

- 1 Open the  Garmin eLog app to start the setup process.
- 2 Follow the on-screen instructions to install the Garmin eLog adapter in the vehicle diagnostic port and complete the pairing process.
- 3 Select **Restore from Backup**.
- 4 Insert a USB storage device containing backup files into the USB port on the Garmin eLog adapter.
The light ring on the adapter glows green and plays a tone when it is ready to restore data.
- 5 Select a backup file.
- 6 Select **Restore**.

Daily Operation Guidelines

The following points are guidelines to follow when using the Garmin eLog system. Your motor carrier may have different operation requirements. Follow your motor carrier's recommendations for daily operation.

- Verify the dēzl is securely mounted in the vehicle and its screen is visible from a normal seated position.
- Verify Bluetooth wireless technology and location services are enabled on your device at all times while using the Garmin eLog adapter.
- Verify the Garmin eLog app is running and the Garmin eLog adapter is secured to the vehicle diagnostic port before starting the vehicle.
- Log in to the Garmin eLog app at the start of each day.
- Review and claim all logs recorded for an unidentified driver, if applicable.
- At the end of each work day, log out of the Garmin eLog app after turning off the engine.
- Certify your records, and submit them to your motor carrier at the end of each day (*Certifying Daily Logs*, page 46).

Starting a Drive









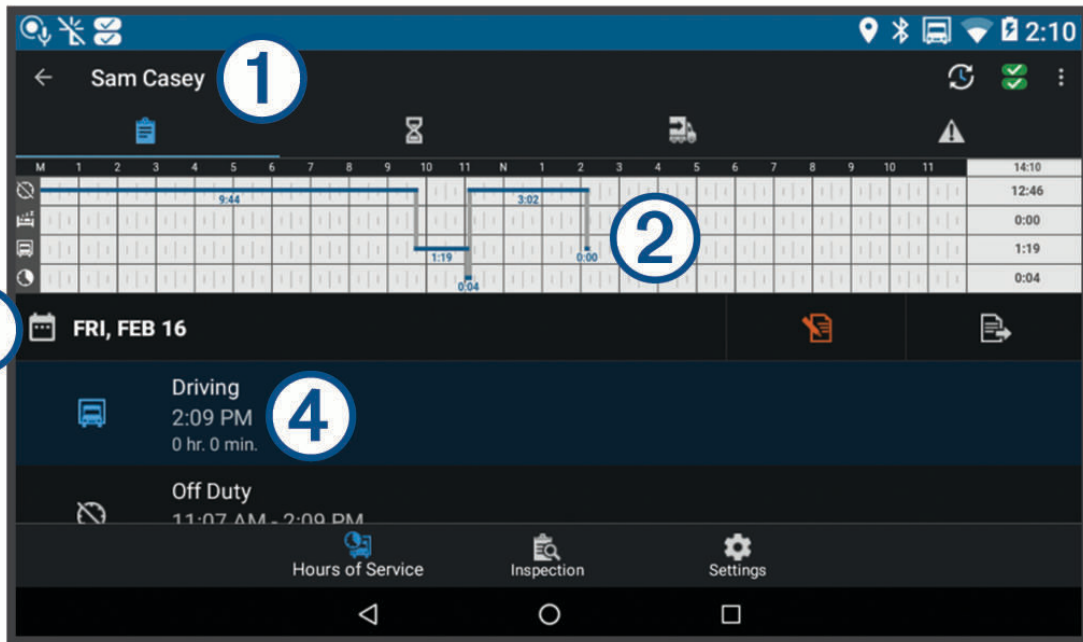







Each time you drive your vehicle, you should complete these actions to ensure your hours of service information is recorded correctly.

- 1 Verify the Garmin eLog adapter is secured to the vehicle diagnostic port.
For more information about installing the Garmin eLog adapter in your vehicle, see the *Garmin eLog Owner's Manual* at garmin.com/manuals/elog.
- 2 Open the Garmin eLog app, and log in as the driver.
- 3 Start your vehicle.
- 4 Before you start driving, change your duty status in the Garmin eLog app.

The Garmin eLog adapter syncs with the Garmin eLog app and records ELD Records of Duty Service (RODS) automatically.

Garmin eLog App Overview



	The name of the active driver.
	Select to change duty status.
	Diagnostic and malfunction indicator. Select to view detailed information about diagnostic or malfunction alerts (Viewing Diagnostics and Malfunctions, page 49). NOTE: The diagnostic and malfunction indicator also appears in the status bar or near the top of every screen on your dēzl device.
	Select to record adverse conditions, create a Records of Duty Status (RODS) report, or log out.
	Select to view a chart of your hours of service information.
	Select to view a summary of currently available on-duty hours.
	Select to review log information.
	Select to view a full-screen chart of your service hours.
	Select to review logs for a different day.
	Select to certify your logs for the selected day.
	Select to submit a 24-hour log to your motor carrier.
	A record of your status for the recorded time period. Select to edit status information and adjust the time.
	Select to view hours of service information.
	Select to manage trailer and shipment information or to create a driver vehicle inspection report.
	Select to view inspection reports and transfer reports to a roadside inspector.
	Select to view additional system settings.

Garmin eLog Map Tool Overview

The Garmin eLog map tool appears on the navigation map automatically while your device is connected to a Garmin eLog adapter. If you close the map tool, you can open it manually by selecting  > **Garmin eLog** from the map.

As you drive, the device displays your duty status and hours of service information in the Garmin eLog map tool.

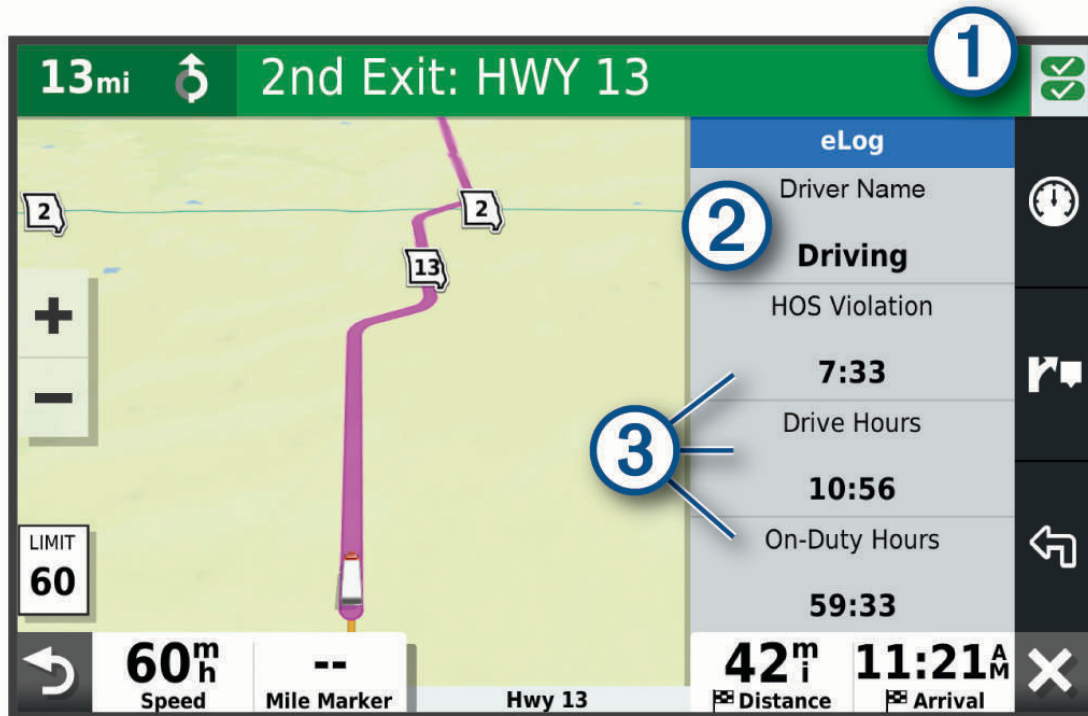

- ① Diagnostic and malfunction indicator. Select to view detailed information about diagnostic or malfunction alerts ([Viewing Diagnostics and Malfunctions, page 49](#)).
- ② Driver name and duty status. Select to change the driver's duty status ([Changing Duty Status, page 45](#)).
NOTE: You cannot change your duty status while driving.
- ③ Current remaining drive hours. Select to view detailed drive hours information in the Garmin eLog app.

Driving in a Team

If you are driving in a team, you can switch between active drivers at any time. Each driver must log in to the Garmin eLog app before they can be set as the active driver.

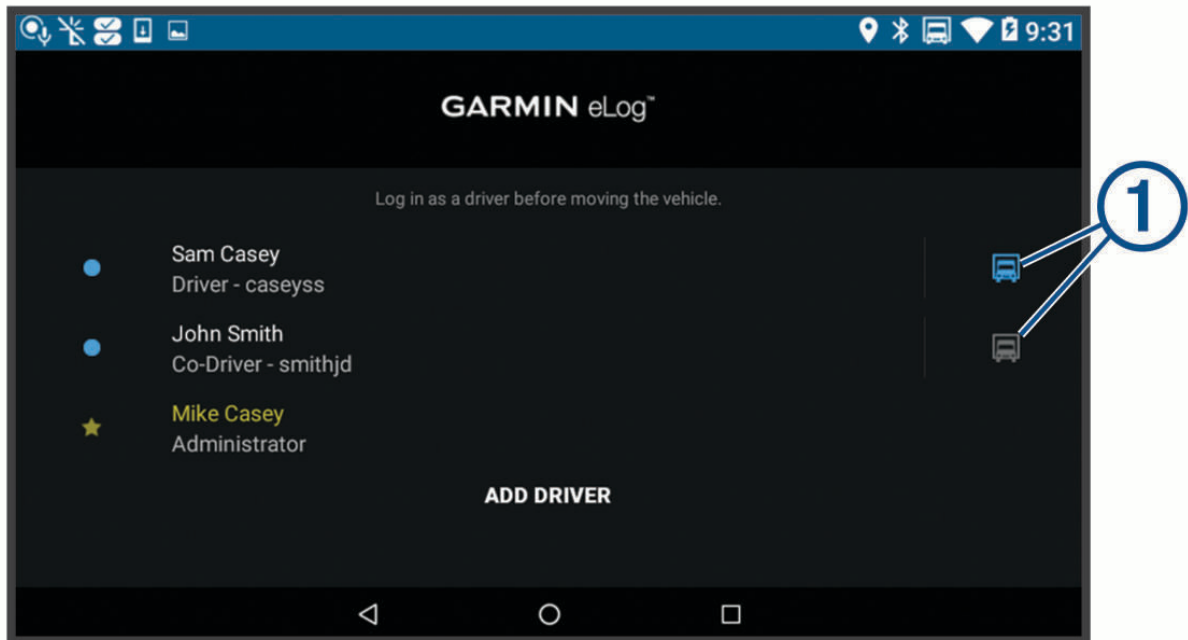

From the Garmin eLog app, select the icon **1** next to the user who should be listed as the active driver.

Changing Duty Status

For the most accurate records, you must change your duty status in the Garmin eLog app every time you change your driving status, such as when you start driving, take a break, switch drivers, or change the type of driving you are doing. The Garmin eLog adapter automatically switches to driving status when the vehicle's diagnostic port reports a speed greater than or equal to five miles per hour. The vehicle is stopped when the diagnostic port reports a speed of zero miles per hour.

NOTE: The vehicle must be stopped to change duty status. You cannot manually change duty status while you are driving.

1 Select an option:

- From the Garmin eLog app, select .
- From the Garmin eLog map tool, select the driver name.

2 Select an option:

NOTE: The Personal Conveyance and Yard Moves options are available only if the administrator has enabled them for your driver profile ([Editing a Driver Profile, page 51](#)).



- If you are on duty, select **On Duty**.
- If you are off duty, select **Off Duty**.
- If you are on duty and driving, select **Driving**.
- If you are moving to the sleeper berth, select **Sleeper Berth**.
- If you are using the vehicle for personal conveyance, select **Personal Conveyance**.
- If you are moving the vehicle within the yard, select **Yard Moves**.

Editing a Duty Status Record

You can update individual duty status entries to make corrections or updates to your duty status history as allowed by FMCSA regulations. This can be useful if you forget to change your duty status.

- 1 From the Garmin eLog app, select the duty status record for the affected time period.
- 2 Select **Duty Status**.
- 3 Select the correct duty status for the time period.
- 4 If necessary, update the start and end times for the duty status entry.
- 5 If necessary, enter the location where this duty status was active.
- 6 Enter an annotation describing the reason for the change.
- 7 Select **Save**.

Viewing Hours of Service

- 1 From the Garmin eLog app, select **HOS**.
- 2 Select an option:
 - To view a chart of your hours of service information, select .
 - TIP:** You can select the chart to view a larger image of your information.
 - To view a list of remaining drive hours, select .

Recording Adverse Conditions

If you require a time extension because of adverse conditions, you can add a two-hour extension to your hours for the day.

From the Garmin eLog app, select  > **Record Adverse Conditions** > **Yes**.

Reviewing Logs

The Garmin eLog app keeps track of logs that may require review, including logs that have been edited or logs that exist for an unidentified driver. When a driver logs in, the app prompts them to review logs that contain an unidentified driver, if any are available. Drivers are responsible for reviewing and claiming logs, if applicable.

- 1 Select **HOS** > .
- 2 Select a log.
- 3 Select an option:
 - If the log applies to you and your hours of service, select **Accept**.
 - If the log does not apply to you, select **Decline**.

Certifying Daily Logs

After you are finished driving for the day, you should certify your daily log. If you update your duty status after certifying it, you must certify it again.

From the Garmin eLog app, select  > **Agree**.

Submitting a Daily Log

You can submit a daily log to your motor carrier.

- 1 From the Garmin eLog app, select .
- 2 Select an option to share your exported log.

Exporting and Saving a Record of Duty Status (RODS) Report

You can create a RODS report so you or your motor carrier can open your records of duty status outside of the Garmin eLog app.

- 1 From the Garmin eLog app, select  > **Create RODS Report**.
- 2 If necessary, select **Create Additional Graph Grid Report** to include a graph grid in your RODS report.
- 3 Select an option:
 - To save the report to the internal storage of your dēzl device, select **Save Report**.
 - To export the report to email, select **Export Report**.

Recording Trailers and Shipments

You can use the Garmin eLog app to keep records of trailers and shipments.

- 1 Select **Vehicle** > .
- 2 Select an option:
 - To add a trailer, select **Add Trailer**.
 - To add a shipment, select **Add Shipment**.
- 3 Enter the trailer number or shipping document number.

Roadside Inspection

Viewing Inspection Information

An authorized safety official may ask to view all information recorded by the Garmin eLog system for the current 24-hour period and any of the previous seven consecutive days. You can view this information on the Garmin eLog app at any time.

From the Garmin eLog app, select **Inspection**.

Transferring Data to an Inspector Using Web Services

Before you can use this feature, you must be connected to a wireless network.

You can submit your RODS report to the FMCSA over the web.

- 1 From the Garmin eLog app, select **Inspection**.
- 2 Select  > **Yes**.
- 3 If necessary, enter an annotation.
- 4 Select **Web Services**.
- 5 Enter your email address, and select **Send Report**.

An email confirmation with your RODS report is sent to the email provided, and the report is submitted to the FMCSA.

Transferring Data to an Inspector Using Email

Before you can use this feature, you must be connected to a wireless network.

You can submit your RODS report to the FMCSA by sending an email.

- 1 From the Garmin eLog app, select **Inspection**.
- 2 Select  > **Yes**.
- 3 If necessary, enter an annotation.
- 4 Select **Email**.
- 5 Enter your email address, and select **Send Report**.

An email confirmation with your RODS report is sent to the email provided, and the report is submitted to the FMCSA.

Transferring Data to an Inspector Using a USB Device

You can transfer data to a USB mass storage device to provide it to an authorized safety official. The Garmin eLog adapter supports USB mass storage devices formatted using the FAT32 file system.

- 1 From the Garmin eLog app, select **Inspection**.
- 2 Select  > **Yes**.
- 3 If necessary, enter an annotation.
- 4 Select **USB**.
- 5 Connect a USB mass storage device to the USB port on your Garmin eLog adapter.
The adapter glows green when it is ready to send the inspection report.
- 6 Enter your password.
- 7 Select **Send to USB Device**.
The Garmin eLog app notifies you when the transfer is complete.
- 8 Remove the USB mass storage device from the adapter.

Transferring Data to an Inspector Using Bluetooth Wireless Technology

The inspector's device must support the Bluetooth Personal Area Networking (PAN) profile and must be able to connect to FMCSA Web Services to complete transfers using Bluetooth wireless technology. Ensure that Bluetooth wireless technology and a Wi-Fi hotspot are enabled on the inspector's mobile device.

The Garmin eLog device uses the inspector's mobile device as a network access point to send inspection information to FMCSA web services.

- 1 From the Garmin eLog app, select **Inspection**.
- 2 Select  > **Yes**.
- 3 If necessary, enter an annotation.
- 4 Select **Bluetooth**.
- 5 Select **Enable Pairing Mode**.
- 6 Follow the on-screen instructions in the app to pair the Garmin eLog adapter with the inspector's mobile device.

The inspection report transfers automatically after the pairing process is complete.

Diagnostics and Malfunctions

The Garmin eLog app records malfunctions and diagnostic events when the app detects critical functions that do not conform to Federal Motor Carrier Safety Administration (FMCSA) specifications. When a malfunction is detected, the driver and motor carrier are subject to responsibilities as directed by FMCSA guidelines.

Driver Responsibilities





- The driver must note the malfunction of the ELD and provide written notice of the malfunction to the motor carrier within 24 hours.
- The driver must reconstruct the Record of Duty Status (RODS) for the current 24-hour period and the previous 7 consecutive days, and record the records of duty status on graph-grid paper logs that comply with 49 CFR 395.8, unless the driver already has the records or retrieves them from the ELD.
- The driver must continue to manually prepare RODS in accordance with 49 CFR 395.8 until the ELD is serviced and returned to a compliant status.

Motor Carrier Responsibilities

- The motor carrier must correct, repair, replace, or service the malfunctioning ELD within eight days of discovering the condition or a driver's notification to the motor carrier, whichever occurs first.
- The motor carrier must require the driver to maintain a paper RODS record until the ELD is back in service.

Viewing Diagnostics and Malfunctions

If the Garmin eLog adapter detects a diagnostic event or malfunction, an alert and an indicator appear in the app. A diagnostic and malfunction indicator also appears in the status bar or near the top of every screen.

	No diagnostic events or malfunctions are detected.
	A diagnostic event was detected.
	A malfunction was detected.
	Diagnostic events and malfunctions were detected.

You can view information about these alerts at any time. This can be useful for correcting errors or adjusting driver information.

Select the diagnostic or malfunction indicator.

The app displays information about the diagnostic or malfunction alert and provides recommendations for how to correct it.

Diagnostic Definitions

Power Data Diagnostic Event: The adapter did not receive power, or was not fully functional, for a period of time.

- 1 Check the vehicle diagnostic port connections.
- 2 Verify the adapter is firmly plugged into the vehicle diagnostic port.
- 3 Review all affected driver logs for missing or incorrect data.

Engine Synchronization Data Diagnostic Event: The adapter failed to synchronize with the vehicle engine computer to record required engine data for driver logs.

- 1 Check the vehicle diagnostic port connections.
- 2 Verify the adapter is firmly plugged into the vehicle diagnostic port.
- 3 Review all affected driver logs for missing or incorrect data.

Missing Required Data Elements Data Diagnostic Event: The Garmin eLog system failed to obtain one or more required data elements when recording driver logs.

- 1 Check the vehicle diagnostic port connections.
- 2 Verify the adapter is firmly plugged into the vehicle diagnostic port.
- 3 Check the Bluetooth settings on the device running the Garmin eLog app, and verify the device and the adapter are connected.
- 4 Check the GPS settings on the device running the Garmin eLog app, and verify the device settings allow location positions to be shared with the Garmin eLog app.
- 5 Review all affected driver logs for missing or incorrect data.

Data Transfer Data Diagnostic Event: A failure occurred with the method for transferring roadside inspection reports.

Perform the following actions:

- 1 Check the Bluetooth settings on the device running the Garmin eLog app, and verify the device and the adapter are connected.
- 2 Verify all USB storage devices used to transfer roadside inspection reports are operating correctly.
- 3 If you have not performed a data backup within the previous seven days, back up your recorded Garmin eLog data to a USB storage device.

Unidentified Driving Records Data Diagnostic Event: At least 30 minutes of unidentified driving was recorded within the current 24 hour period, and over the previous 7 days.

- Drivers: Review and claim the unidentified driving time.

- Administrator: Review and assign the unidentified driving time to the respective drivers.

Malfunction Definitions

Power Compliance Malfunction: The adapter did not receive power, or was not fully functional, for a period of time. At least 30 minutes of driving time may not have been correctly recorded across all drivers over the past 24 hours.

- 1 Check the vehicle diagnostic port connections.
- 2 Verify the adapter is firmly plugged into the vehicle diagnostic port.
- 3 Review all affected driver logs for missing or incorrect data.

Engine Synchronization Compliance Malfunction: The adapter failed to synchronize with the vehicle engine computer to record required engine data for driver logs. At least 30 minutes of inaccurate data may have been recorded across all drivers over the past 24 hours.

- 1 Check the vehicle diagnostic port connections.
- 2 Verify the adapter is firmly plugged into the vehicle diagnostic port.
- 3 Review all affected driver logs for missing or incorrect data.

Timing Compliance Malfunction: The Garmin eLog system failed to accurately verify the calendar date or time of day required for driver logs.

- 1 Verify the adapter is firmly plugged into the vehicle diagnostic port.
- 2 Check the Bluetooth settings on the device running the Garmin eLog app, and verify the device and the adapter are connected.
- 3 Check the date and time settings on the device running the Garmin eLog app.
- 4 Review all affected driver logs for missing or incorrect data.

Positioning Compliance Malfunction: The Garmin eLog system failed to acquire valid location positions required for driver logs. At least 60 minutes of inaccurate data may have been recorded across all drivers over the past 24 hours.

- 1 Verify the Garmin eLog app is running and a driver is logged in when driving the vehicle.
- 2 Check the Bluetooth settings on the device running the Garmin eLog app, and verify the device and the adapter are connected.
- 3 Check the GPS settings on the device running the Garmin eLog app, and verify the device settings allow location positions to be shared with the Garmin eLog app.
- 4 Review all affected driver logs for missing or incorrect data.

Data Recording Compliance Malfunction: The Garmin eLog system has reached the maximum storage capacity for driver logs and cannot store or retrieve more logs.

- 1 Create a RODS report for each driver for record keeping ([Exporting and Saving a Record of Duty Status \(RODS\) Report, page 47](#)).
- 2 Log in as an administrator.
- 3 Back up the system data ([Backing Up Data, page 41](#)).
- 4 Remove unneeded files from the storage of the device running the Garmin eLog app.

Data Transfer Compliance Malfunction: Multiple failures occurred with the method for transferring roadside inspection reports.

Perform the following actions:

- 1 Check the Bluetooth settings on the device running the Garmin eLog app, and verify the device and the adapter are connected.
- 2 Verify all USB storage devices used to transfer roadside inspection reports are operating correctly and are formatted using the FAT32 file system.
- 3 If you have not performed a data backup within the previous seven days, back up your recorded Garmin eLog data to a USB storage device.

Adapter Firmware Malfunction: A serious error occurred attempting to update the adapter firmware. Contact Garmin customer support for further help.

Outdated adapter firmware may not maintain compliance. Garmin recommends keeping paper logs until the adapter firmware is successfully updated.

Administrator Functions

NOTICE

The administrator account is critical for some app functions. Choose an administrator password you can remember, and do not lose the password. The administrator password cannot be recovered without clearing all app data, which causes all recorded Garmin eLog data to be deleted.

You must use the administrator account to perform some Garmin eLog app functions, including adding driver profiles, editing driver profiles, and resetting driver passwords. The administrator account and password are created during the initial Garmin eLog app setup. If the app is administered by a company, drivers may not have access to the administrator functions.

Adding Driver Profiles

You must log in as an administrator to add driver profiles.

- 1 From the Garmin eLog app, select **Add Driver**.
- 2 Enter the administrator password.
- 3 Enter the driver and motor carrier information.
- 4 If the driver has an exempt status, select **Exempt Driver**.
- 5 If the driver is allowed to use the vehicle for personal conveyance, select **Allow Personal Conveyance**.
- 6 If the driver is allowed to make yard moves, select **Allow Yard Moves**.
- 7 Select **Save**.

The first time the driver logs into the new profile, the app prompts the driver to enter their driver license number and create a password.

Editing a Driver Profile

An administrator can edit driver profiles to change driver privileges, reset profile passwords, or deactivate profiles.

NOTE: The administrator can edit basic driver information in the driver profile, but the Garmin eLog app does not support editing duty status records from the administrator account. To correct a duty status record, the driver must log in to the driver profile and edit the record ([Editing a Duty Status Record, page 46](#)).

- 1 Log in to an administrator account.
- 2 Select a driver profile.
- 3 Select  > **Edit Profile**.
- 4 Select an option:
 - To edit driver information, select a field to update it.
 - To reset the profile password, select **Reset Password**.
 - To deactivate the profile, select **Deactivate Profile**.

Clearing Garmin eLog App Data

NOTICE

Clearing the Garmin eLog app data will cause all retained ELD data to be deleted from your dēzl device. It is the responsibility of the driver and/or motor carrier to ensure ELD records are retained as required by applicable regulations.

You can clear the Garmin eLog app data to restore the app to the original factory state. This requires you to set up your Garmin eLog adaptor, administrator account, and all driver profiles again. Clearing the app data is also the only way to reset a lost or forgotten administrator password.

- 1 Log in to a driver or administrator account, and back up all data ([Backing Up Data, page 41](#)).
- 2 Wait for the backup to complete.
- 3 From the home screen, select **Settings > Device > Apps > eLog > Storage**.
- 4 Select **Clear Data**.

Voice Command

NOTE: Voice command is not available for all languages and regions, and may not be available on all models.

NOTE: Voice Activated Navigation may not achieve desired performance when in a noisy environment.

Voice command allows you to use your device by saying words and commands. The voice command menu provides voice prompts and a list of available commands.

Tips for Speaking to the Device

- Speak in a clear voice directed at the device.
- Start each request with *OK, Garmin*.
- Reduce background noise, such as voices or the radio, to help the device interpret your commands more accurately.
- Respond to voice prompts from the device as needed.
- If you do not receive a useful response, try rephrasing your request.
- If the device does not respond to your requests, verify it is not placed near a speaker or air vent, which can produce noise that interferes with the microphone.

Launching Garmin Voice-Activated Navigation

Garmin voice-activated navigation allows you to use plain language spoken requests to search for locations and addresses, start routes with turn-by-turn directions, place hands-free phone calls, and more.

- Say *OK, Garmin*, and make a spoken request.
For example, you can say phrases like these:
 - *OK, Garmin, take me home.*
 - *OK, Garmin, where's the library?*

Checking Your Arrival Time

While a route is active, you can say a phrase to check your estimated time of arrival at your destination.

Say *OK, Garmin, what time will we arrive?*

Placing a Phone Call Using Your Voice

You can use a voice command to call to a contact from the phone book of your paired smartphone.

Say *OK, Garmin, call*, and say the contact name.

For example, you can say *OK, Garmin, call Mom..*

Changing Device Settings Using Your Voice

You can say phrases like these to set device settings to a value from 0 to 10.

- *OK, Garmin, increase the volume.*
- *OK, Garmin, set the volume to 0.*
- *OK, Garmin, set the volume to 9.*

Using the Apps

Viewing the Owner's Manual on Your Device

You can view the complete owner's manual on the device screen in many languages.

- 1 Select  > **Tools** > **Owner's Manual**.

The owner's manual appears in the same language as the software text ([Setting the Text Language](#), page 61).

- 2 Select  to search the owner's manual (optional).

Viewing the Truck Map

The truck map highlights recognized truck routes on the map, such as the Surface Transportation Assistance Act (STAA) preferred routes, TruckDown® (TD) preferred routes, and non-radioactive hazardous materials (NRHM) routes. The recognized routes vary based on your area and the map data loaded on your device.

Select  > **dēzl** > **Truck Map**.



Route Planner

You can use the route planner to create and save a route, which you can navigate later. This can be useful for planning a delivery route, a vacation, or a road trip. You can edit a saved route to further customize it, including reordering locations, adding suggested attractions, and adding shaping points.





You can also use the route planner to edit and save your active route.

Planning a Route

A route can include many locations, and it must include at least a starting location and one destination. The starting location is the location from which you plan to start your route. If you start navigating the route from a different location, the device gives you the option to route to your starting location first. For a round trip, the starting location and final destination can be the same.

- 1 Select  > **dēzl** > **Route Planner** > **Create Route**.
- 2 Select **Select Start Location**.
- 3 Choose a location for your starting point, and select **Select**.
- 4 Select **Select Destination**.
- 5 Choose a location for a destination, and select **Select**.
- 6 Select **Add Location** to add more locations (optional).
- 7 After you have added all the necessary locations, select **Next** > .
- 8 Enter a name, and select **Done**.

Editing and Reordering Locations in a Route

- 1 Select **Route Planner**.
- 2 Select a saved route.
- 3 Select **List**.
- 4 Select a location.
- 5 Select an option:
 - To change the location, select , and enter a new location.
 - To move the location up or down, select , and drag the location to a new position in the route.
 - To add a new location after the selected location, select .
 - To remove the location, select .

Changing Routing Options for a Route

You can customize how the device calculates your route.

- 1 Select **Route Planner**.
- 2 Select a saved route.
- 3 Select .
- 4 Select an option:
 - To add shaping points to your route, select **Shaping**, and select at least one location.
 - To change the calculation mode for the route, touch a route segment, and select a calculation mode.

Navigating to a Saved Route

- 1 Select **Route Planner**.
- 2 Select a saved route.
- 3 Select **Go!**.
- 4 Select the first location to navigate to, and select **OK**.

The device calculates a route from your current location to the selected location, and then it guides you to the remaining route destinations in order.

Editing and Saving Your Active Route

If a route is active, you can use the route planner to edit and save it.

- 1 Select **Route Planner > My Active Route**.
- 2 Edit your route using any of the route planner features.

The route recalculates each time you make a change.
- 3 Select **Save** to save your route, which you can navigate again later (optional).

Viewing Previous Routes and Destinations

Before you can use this feature, you must enable the travel history feature ([Device Settings, page 62](#)).

You can view your previous routes and places you have stopped on the map.

Select  > **dēzl** > **Trip History**.

Viewing the Weather Forecast

Before you can use this feature, your device must be receiving weather data. You can connect your device to the dēzl app to receive weather data.

- 1 From the home screen, select the weather widget ([Home Screen, page 7](#)).

The device shows the current weather conditions and a forecast for the next several days.
- 2 Select a day.

The detailed forecast for that day appears.

Viewing Weather Near a Different City

- 1 Select  > **dēzl** > **Weather** > **Current Location**.
- 2 Select an option:
 - To view weather for a favorite city, select a city in the list.
 - To add a favorite city, select **Add City**, and enter a city name.

Music Player

The media player allows your device to control the media currently playing from a media app on your paired phone. You can open the media player at any time by selecting  > **Tools** > **Music** from the main menu.

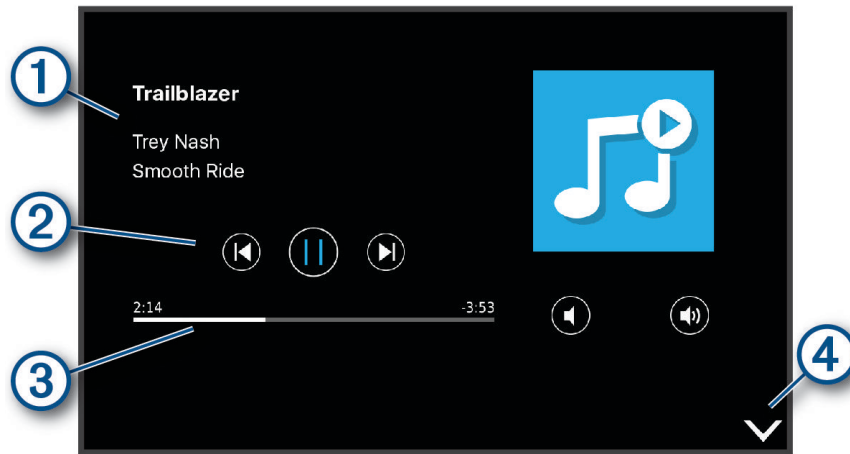

- | | |
|---|---|
| ① | Information about the currently playing media, such as title, artist, album, station, or channel. |
| ② | Progress through the current media item. |
| ③ | Playback controls. The controls change based on the service providing the media. |
| ④ | Select to hide or shrink the media player. |



Adding the Music Player Tool to the Map

The music player map tool enables you to control the music player from your map.

- 1 Open the map.
- 2 Select  > **Music**.
The music player controls appear on the map.

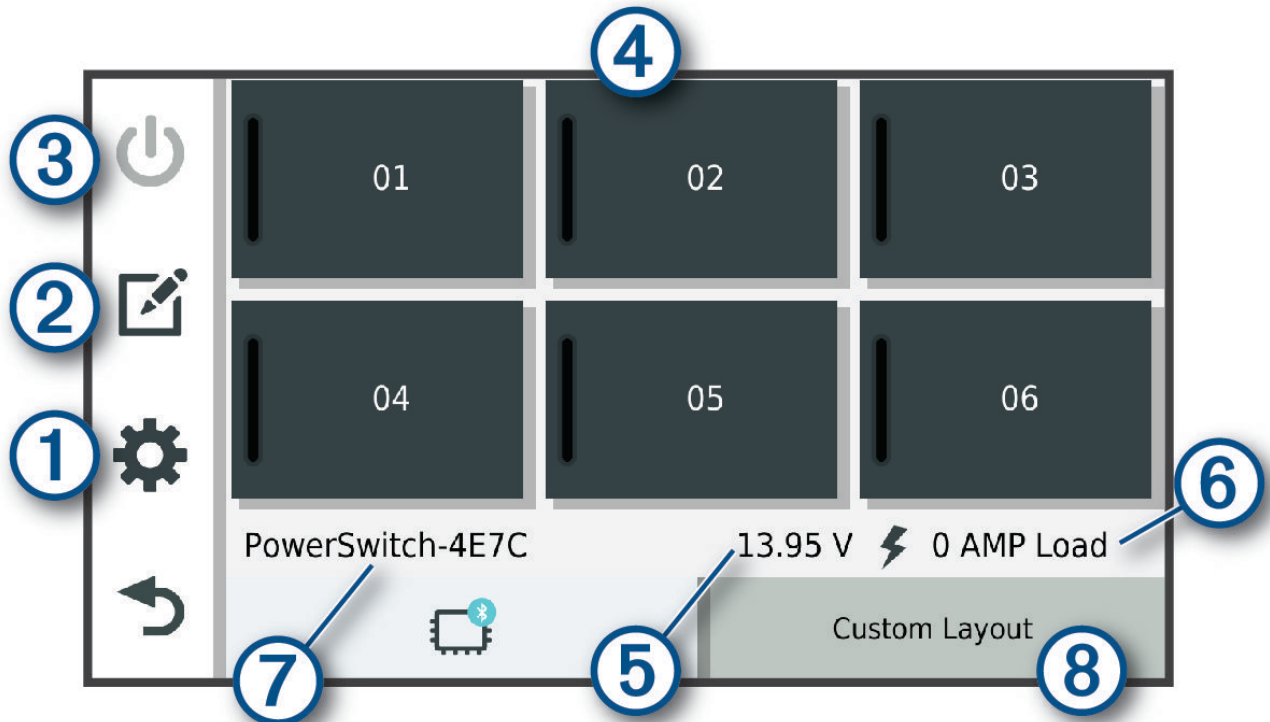
Garmin PowerSwitch™ App



① 	Opens the app settings menu
② 	Enters editing mode to customize the app layout and functions
③ 	Turns off all outputs
④ Power buttons	Activates each connected output
⑤	Displays input voltage
⑥	Displays the total amperage of the selected Garmin PowerSwitch device
⑦	Displays the device name
⑧	Displays Garmin PowerSwitch device tabs and custom layout tabs

Activating a Power Switch



Before you can use the Garmin PowerSwitch app to activate a switch, you must install your Garmin PowerSwitch device in your vehicle and pair it with the Garmin PowerSwitch app.

From the Garmin PowerSwitch app, select a power button to turn a switch on or off.

Turning Off All Switches

Select .

Customizing a Button

- 1 From the Garmin PowerSwitch app screen, select .
The app enters editing mode.
- 2 Select  on the button you want to customize.
- 3 Select an option:
 - To change the name of the button, select the **Button Label** field, and enter a name.
 - To add an icon to the button, select the **Icon** field, and select an icon.
 - To change the button color, select a color.
 - To change the button mode, select a button mode.
 - To adjust the intensity of the switch, use the slider.
 - To set the button to activate with a control input, select a control input.
- 4 Select .
- 5 Select **Done**.

Assigning a Switch to a Control Input



Before you can use control input functions, you must connect a control input to your Garmin PowerSwitch device.

You can assign one or more switches to turn on when the Garmin PowerSwitch device receives a signal from a control input.



- 1 Select .
- 2 Select your Garmin PowerSwitch device.
- 3 Select a control input.
- 4 Select one or more switches.

Adding a Custom Layout



You can add a custom layout tab to the Garmin PowerSwitch app. Buttons added to a custom layout can control multiple switches at the same time.

- 1 From the Garmin PowerSwitch app, select .
The device enters editing mode.
- 2 Select .



Adding a Button to a Custom Layout

- 1 From the Garmin PowerSwitch app, select a custom layout tab.
- 2 Select .
The app enters editing mode.
- 3 Select **Add Button**.
- 4 On the new button, select .
- 5 Select an option:
 - To change the name of the button, select the **Button Label** field, and enter a name.
 - To add an icon to the button, select the **Icon** field, and select an icon.
 - To change the button color, select a color.
- 6 Select **Add Action**.
- 7 If necessary, select a Garmin PowerSwitch device and a switch.
- 8 Select an action:
 - To set the button to turn the switch on or off with each press, select **Toggle**.
 - To set the button to turn on the switch, select **Turn On**.
 - To set the button to turn off the switch, select **Turn Off**.
- 9 Select a button mode:
 - To set the button to activate with one touch, select **Normal**.
 - To set the button to activate only while touching the button, select **Momentary**.
 - To set the button to turn on and off repeatedly, select **Strobe**, and select time intervals.
- 10 If applicable, use the slider to set the brightness of lights.
- 11 Select .
- 12 If necessary, select **Add Action** to add additional actions for the button.
You can add one action for every switch on the Garmin PowerSwitch device.

Arranging Buttons In a Custom Layout

- 1 From the Garmin PowerSwitch app, select a custom layout tab.
- 2 Select .
The app enters editing mode.
- 3 On the button you want to move, hold  and drag the button to a new location.

Deleting a Custom Layout or Button

- 1 From the Garmin PowerSwitch app, select a custom layout tab.
- 2 Select .
The app enters editing mode.
- 3 Select an option:
 - To delete a button, select  on the button you want to delete.
 - To delete a layout tab, select  on the layout tab.



Routines

Routines automate your Garmin PowerSwitch device. When you define a routine on your compatible Garmin navigation device, it turns switches on or off automatically when the conditions of the routine are met. For example, you can set a routine to turn on a switch at specific time each day or when your vehicle reaches a specific speed. Routines are available only when using a compatible Garmin navigation device.



Adding a Routine

- 1 From the Garmin PowerSwitch app, select  > **Routines**.
- 2 If necessary, select **Add Routine**.
- 3 Select **When**.
- 4 Select a trigger:
 - To set a switch to trigger when your vehicle reaches a specific speed, select **Speed** > **Next**, and follow the on-screen instructions to enter speed thresholds.
 - To set a switch to trigger at a specific time each day, select **Time** > **Next**, and enter a time.
 - To set a switch to trigger at sunrise, select **Sunrise**.
 - To set a switch to trigger at sunset, select **Sunset**.
- 5 Select **Add Action**.
- 6 Select a device, a switch, an action, and a button mode.
- 7 If necessary, use the slider to adjust the dimmer.
- 8 Select **Save**.

Editing a Routine

- 1 From the Garmin PowerSwitch app, select  > **Routines**.
- 2 Select  on the routine you want to edit.
- 3 Select an option:
 - To change the trigger for the routine, select **When**, and select a trigger.
 - To change an action, select  on the action you want to change, and update the action.
 - To add an action to the routine, select **Add Action**, and enter information about the action.
- 4 Select **Save**.

Deleting a Routine

- 1 From the Garmin PowerSwitch app, select  > **Routines**.
- 2 Select  on the routine you want to delete.

Settings

Navigation Settings

Select **Settings** > **Navigation**.

Calculation Mode: Sets the route calculation method.

Avoidances: Sets road features to avoid on a route.

Custom Avoidances: Allows you to avoid specific roads or areas.

Restricted Mode: Disables all functions that require significant operator attention.

Voice Language: Sets the language for navigation voice prompts.

Travel History: Allows the device to store a record of the places you go. This allows you to view the trip log, use the Trip History feature, and use myTrends suggested routes.

Clear Travel History: Allows you to clear all travel history from the device.

Map and Vehicle Settings

Select **Settings > Map Display**.

Map Vehicle Icon: Sets the vehicle icon that represents your position on the map.

Driving Map View: Sets the perspective on the map.

Map Detail: Sets the level of detail on the map. More detail may cause the map to draw slower.

Map Theme: Changes the color of the map data.

Map Layers: Sets the data that appears on the map page (*Customizing the Map Layers, page 31*).

Auto Zoom: Automatically selects the zoom level for optimal use of your map. When disabled, you must zoom in or out manually.

Units: Sets the unit of measure used on the map.

myMaps: Sets which installed maps the device uses.

Enabling Maps

You can enable map products installed on your device.

TIP: To purchase additional map products, go to garmin.com/maps.

- 1 Select **Settings > Map Display > myMaps**.
- 2 Select a map.

Connecting to a Wireless Network

- 1 Select **Settings > Wireless Networks > Wi-Fi**.
- 2 If necessary, select the toggle switch to turn on wireless network technology.
- 3 Select a wireless network.
- 4 If necessary, enter the encryption key.

The device connects to the wireless network. The device remembers the network information and connects automatically when you return to this location in the future.

Enabling Bluetooth Wireless Technology

Select **Settings > Wireless Networks > Bluetooth**.

Driver Assistance Settings

Select **Settings > Driver Assistance**.

Driver Alerts: Enables an audible alert for each type of driver alert (*Driver Awareness Features and Alerts, page 11*).

Proximity Alerts: Alerts you when you approach speed cameras or red light cameras.

Route Preview: Shows a preview of the major roads in your route when you start navigation.

Break Planning: Enables break planning features that monitor your driving time, suggest breaks, and show upcoming services.

Traffic Settings

From the main menu, select **Settings > Traffic**.

Traffic: Enables the traffic feature.

Current Provider: Sets the traffic provider to use for traffic data. The Auto option selects the best available traffic data automatically.

Subscriptions: Lists the current traffic subscriptions.

Optimize Route: Enables the device to use optimized alternate routes automatically or upon request (*Avoiding Traffic Delays on Your Route, page 25*).

Display Settings

Select **Settings > Device > Display**.

Brightness level: Sets the display brightness level on your device.

Dark theme: Enables or disables the dark color theme.

Wallpaper: Sets the wallpaper background on your device.

Screen timeout: Allows you to set the amount of idle time before your device turns off the display while using battery power.

Font size: Increases or decreases the font size on your device.

Auto-rotate screen: Enables the screen to rotate automatically between portrait and landscape display modes based on the device orientation or remain in the current orientation.

Sound and Notification Settings

Select **Settings > Device > Sound & Notification**.

Volume Sliders: Set the volume levels for navigation, media, calls, alarms, and notification alerts.

Do Not Disturb: Sets the rules for the automatic do-not-disturb feature. This feature allows you to disable audible alerts during specific times or events.

Default notification sound: Sets the default notification ringtone sound on your device.

Default alarm sound: Sets the default alarm sound on your device.

Other sounds: Allows you to enable or disable sounds for other device interactions, such as screen touches, screen locking, or charging.

Adjusting Sound and Notification Volume

- 1 Select **Settings > Device > Sound & Notification**.
- 2 Use the slider bars to adjust the sound and notification volume.

Enabling or Disabling Location Services

The location services feature must be enabled for your device to find your location, calculate routes, and provide navigational assistance. You can disable location services to plan a route when GPS signals are not available. When location services are disabled, the device enables a GPS simulator to calculate and simulate routes.

TIP: Disabling location services can help save battery power.

- 1 Select **Settings > Personal > Location**.
- 2 Select the toggle switch to enable or disable location services.

Setting the Text Language

You can select the language for text in the device software.

- 1 Select **Settings > Personal > Language & Input > Language**.
- 2 Select a language.

Date and Time Settings

Select **Settings > System > Date & Time**.

Use network-provided time: Automatically sets the time zone based on information from the connected network.

Use network-provided time zone: Sets the time zone on your device when Use network-provided time is disabled.

Use 24-hour format: Enables or disables the 24-hour time format.

Device Settings

Select **Settings > About Device**.

Legal Information: Allows you to view the end-user license agreement (EULA) and software license information.

Regulatory information: Displays e-label regulatory and compliance information.

Garmin device information: Displays hardware and software version information.

Device Information

Viewing E-label Regulatory and Compliance Information

- 1 From the settings menu, swipe to the bottom of the menu.
- 2 Select **About Device > Regulatory information**.

Specifications

Operating temperature range	From -20° to 60°C (from -4° to 131°F)
Charging temperature range	From 0° to 45°C (from 32° to 113°F)
Power input	Vehicle power using the included vehicle power cable. AC power using an optional accessory (for home and office use only).
Battery type	Rechargeable lithium-ion

Charging the Device

NOTE: This Class III product shall be powered by an LPS power supply.

You can charge the battery in the device using any of these methods.

- Install the device in the mount, and connect the mount to vehicle power.
- Connect the device to an optional power adapter accessory, such as a wall power adapter.
You can purchase an approved Garmin AC-DC adapter suitable for home or office use from a Garmin dealer or www.garmin.com. The device may charge slowly when connected to a third-party adapter.

Device Maintenance

Garmin Support Center

Go to support.garmin.com for help and information, such as product manuals, frequently asked questions, videos, and customer support.

Updating Maps and Software Using a Wi-Fi Network

NOTICE

Map and software updates may require the device to download large files. Regular data limits or charges from your internet service provider apply. Contact your internet service provider for more information about data limits or charges.

You can update the maps and software by connecting your device to a Wi-Fi network that provides access to the internet. This allows you to keep your device up to date without connecting it to a computer.

1 Using the included USB cable, connect the device to external power.

NOTE: A USB power adapter is not included. Go to the product page on garmin.com to purchase a power adapter accessory.

2 Connect the device to a Wi-Fi network ([Connecting to a Wireless Network](#), page 60).

While connected to a Wi-Fi network, the device checks for available updates automatically and displays a notification when an update is available.

3 Select an option:

- When an update notification appears, swipe down from the top of the screen, and select **An update is available..**
- To manually check for updates, select **Settings > Updates.**

The device displays available map and software updates. When an update is available, **Update Available** appears below Map or Software.

4 Select an option:

- To install all available updates, select **Download.**
- To install only map updates, select **Map.**
- To install only software updates, select **Software.**

5 If necessary, read the license agreements, and select **Accept All** to accept the agreements.

NOTE: If you do not agree with the license terms, you can select **Reject.** This stops the update process. You cannot install updates until you accept the license agreements.

6 Keep the device connected to external power and within range of the Wi-Fi network until the update process is complete.

TIP: If a map update is interrupted or canceled before it completes, your device may be missing map data. To repair missing map data, you must update the maps again.

Updating Maps and Software with Garmin Express

You can use the Garmin Express application to download and install the latest map and software updates for your device.

- 1 If you do not have the Garmin Express application installed on your computer, go to garmin.com/express and follow the on-screen instructions to install it (*Installing Garmin Express, page 65*).
- 2 Open the  Garmin Express application.
- 3 Connect your device to your computer using a USB cable.

The small end of the cable connects to the USB port  on your dēzl device, and the large end connects to an available USB port on your computer.

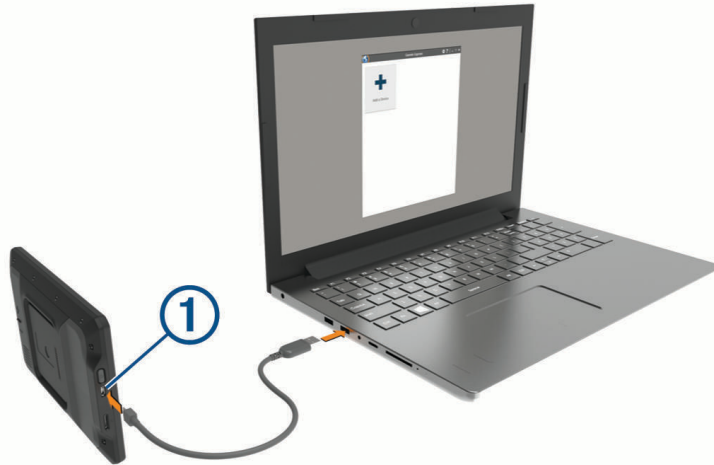

- 4 In the Garmin Express application, click **Add a Device**.
The Garmin Express application searches for your device and displays the device name and serial number.
- 5 Click **Add Device**, and follow the on-screen instructions to add your device to the Garmin Express application.
When setup is complete, the Garmin Express application displays the updates available for your device.

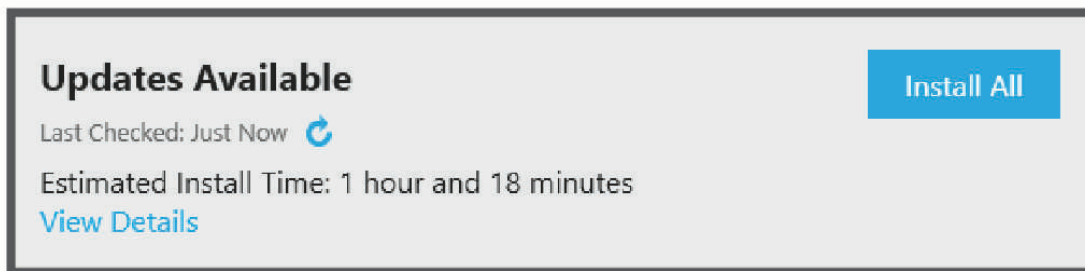

- 6 Select an option:
 - To install all available updates, click **Install All**.
 - To install a specific update, click **View Details**, and click **Install** next to the update you want.The Garmin Express application downloads and installs the updates onto your device. Map updates are very large, and this process may take a long time on slower internet connections.

NOTE: If a map update is too large for the internal storage of the device, the software may prompt you to install a microSD[®] card in your device to add storage space (*Installing a Memory Card for Maps and Data, page 75*).

- 7 Follow the on-screen instructions during the update process to finish installing updates.
For example, during the update process, the Garmin Express application may instruct you to disconnect and reconnect your device.

Installing Garmin Express

The Garmin Express application is available for Windows® and Mac® computers.

- 1 On your computer, go to garmin.com/express.
- 2 Select an option:
 - To view the system requirements and verify the Garmin Express application is compatible with your computer, select **System Requirements**.
 - To install on a Windows computer, select **Download for Windows**.
 - To install on a Mac computer, select **Download for Mac**.
- 3 Open the downloaded file, and follow the on-screen instructions to complete the installation.

Device Care

NOTICE

Avoid dropping your device.

Do not store the device where prolonged exposure to extreme temperatures can occur, because it can cause permanent damage.

Never use a hard or sharp object to operate the touchscreen, or damage may result.

Do not expose the device to water.

Cleaning the Outer Casing

NOTICE

Avoid chemical cleaners and solvents that can damage plastic components.

- 1 Clean the outer casing of the device (not the touchscreen) using a cloth dampened with a mild detergent solution.
- 2 Wipe the device dry.

Cleaning the Touchscreen

- 1 Use a soft, clean, lint-free cloth.
- 2 If necessary, lightly dampen the cloth with water.
- 3 If using a dampened cloth, turn off the device and disconnect the device from power.
- 4 Gently wipe the screen with the cloth.

Avoiding Theft

- Remove the device and mount from sight when not in use.
- Remove the residue left on the windshield by the suction cup.
- Do not keep your unit in the glove compartment.
- Register your device using the Garmin Express software (garmin.com/express).

Resetting the Device

You can reset your device if it stops functioning.

Hold the power key for 12 seconds.

Removing the Device, Mount, and Suction Cup

Removing the Mount from the Suction Cup

- 1 Loosen the nut that secures the magnetic powered mount to the suction cup ball.
- 2 Turn the device mount to the right or left.
- 3 Apply pressure until the socket on the mount releases the ball on the suction cup.

Removing the Suction Cup from the Windshield

- 1 Flip the lever on the suction cup toward you.
- 2 Pull the tab on the suction cup toward you.

Troubleshooting

The suction cup will not stay on my windshield

- 1 Clean the suction cup and windshield with rubbing alcohol.
- 2 Dry with a clean, dry cloth.
- 3 Mount the suction cup ([Mounting and Powering the Device in Your Vehicle, page 2](#)).

The mount does not hold my device in place while I drive

For the best results, you should keep the vehicle mount clean and position the device close to the suction cup. If the device shifts position while you are driving, you should complete these actions.

- Remove the powered mount from the suction cup arm, and wipe the ball and socket with a cloth. Dust and other debris may reduce the friction in the ball and socket joint and allow the joint to shift while you are driving.
- Rotate the hinged arm toward the suction cup as far as your windshield angle allows. Positioning the device closer to the windshield reduces the effect of jarring and vibration from the road.

My device is not acquiring satellite signals

- Verify the location services feature is enabled ([Enabling or Disabling Location Services, page 61](#)).
- Take your device out of parking garages and away from tall buildings and trees.
- Remain stationary for several minutes.

The device does not charge in my vehicle

- Verify the vehicle is turned on and is supplying power to the power outlet.
- Verify the interior temperature of the vehicle is within the charging temperature range indicated in the specifications.
- In the vehicle fuse box, verify the fuse for the vehicle power outlet is not broken.

My battery does not stay charged for very long

- Decrease the screen brightness ([Display Settings, page 61](#)).
- Shorten the display timeout ([Display Settings, page 61](#)).
- Decrease the volume ([Adjusting Sound and Notification Volume, page 61](#)).
- Turn off the wi-fi radio when it is not in use ([Connecting to a Wireless Network, page 60](#)).
- Put the device in power saving mode when not in use ([Turning the Device On or Off, page 6](#)).
- Keep your device away from extreme temperatures.
- Do not leave your device in direct sunlight.

My device does not connect to my phone

- Select **Settings > Bluetooth**.
The Bluetooth option must be enabled.
- Enable Bluetooth wireless technology on your phone and bring your phone within 10 m (33 ft.) of the device.
- Verify your phone is compatible.
Go to www.garmin.com/bluetooth for more information.
- Complete the pairing process again.
To repeat the pairing process, you must unpair your phone and device (*Deleting a Paired Phone*, page 35), and complete the pairing process.

Appendix

Garmin PowerSwitch

WARNING

Garmin strongly recommends having an experienced installer with the proper knowledge of electrical systems install the device. Incorrectly wiring the power cable can result in damage to the vehicle or the battery and can cause bodily injury.

You can use a connected Garmin PowerSwitch device to control lights, fans, and more from your dēzl device.

Mounting Considerations

- The device must be mounted close to the battery and within the range of the supplied power cable.
- The mounting surface must be strong enough to support the weight of the device.
- The location must allow room for the routing and connection of all cables.

Mounting the Device

Before you can mount the device, you must select a mounting location and purchase the appropriate hardware for your mounting surface.

NOTICE

Avoid wires, gauges, air bags, air bag covers, HVAC, and other items when drilling pilot holes and attaching the mount to the vehicle. Garmin is not responsible for any damages or consequences arising from the installation.

- 1 Place the mount on the selected location.



- 2 Using the mount as a template, mark the two screw locations ①.
- 3 Drill pilot holes (optional).
For some types of mounting material, drilling pilot holes is necessary. Do not drill through the mount.
- 4 Securely fasten the mount to the surface using the appropriate hardware for your mounting surface.

Opening the Front Cover

You must open the front cover to make electrical connections.

- 1 Lift the front cover latch ① and rotate it counter-clockwise.



- 2 Pull the front cover off of the device.



Connecting Accessories

NOTICE

Do not use the device to control or power a winch. Failure to follow this notice could cause damage to your vehicle or your device.

Do not connect a power source to an accessory output terminal. Failure to follow this notice could cause damage to your vehicle or your device.

Accessory requirements:

- Verify the amperage rating of each accessory before wiring it to the Garmin PowerSwitch device. The device supports accessories up to 30 A for each channel and a maximum of 100 A for the entire system.
 - Use 10 AWG (6 mm²) wires for accessories that use 20 to 30 A.
 - Use 12 AWG (4 mm²) wires for accessories that use 10 to 20 A.
 - Use 14 AWG (2.5 mm²) wires for accessories that use less than 10 A.
 - Use the appropriate size terminals for all accessory connections.
 - Crimp all terminal connectors securely.
- 1 Connect the positive wire from the accessory ① to one of the accessory terminals ② on the Garmin PowerSwitch device.

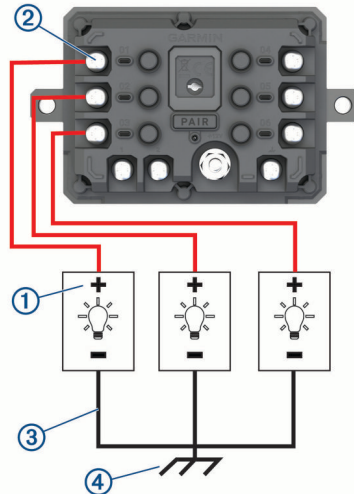

- 2 Connect the negative or ground wire ③ to an unpainted ground stud ④ on the vehicle frame, to a ground distribution block, or directly to the negative terminal on the battery.

⚠ CAUTION

Do not connect the accessory ground wires to the ground terminal (GND) on the Garmin PowerSwitch device, as doing so could result in personal injury or property damage, or could negatively impact device functionality.

- 3 Verify that all electrical connections are tight and will not come loose during use.

Connecting a Control Input

You can connect to the control terminals to enable the Garmin PowerSwitch device to turn on customizable outputs. For example, you can connect your vehicle ignition switch to a control input terminal to turn on accessories automatically each time you start your vehicle. The control terminals detect a signal from 3.3 V to 18 V. You can configure output functions with the Garmin PowerSwitch app.

Connect the control wire from the control source in your vehicle to one of the two control terminals on the Garmin PowerSwitch device.

Connecting the Device to Vehicle Power

Before you can connect the device to vehicle power, you must remove the warning tag from the +12V terminal on the device.

You should always confirm all electrical connections are secure and will not come loose while operating the device.

- 1 Connect the large ring end of the included ground wire ① to the negative terminal on the vehicle battery.

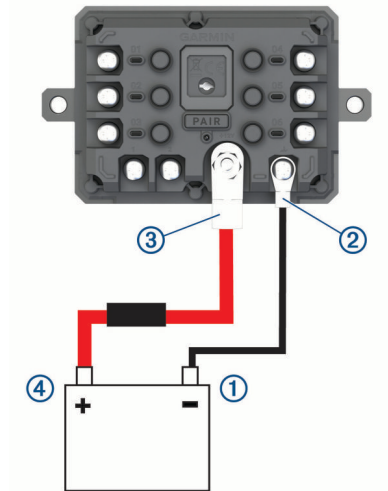

- 2 Connect the small ring end of the ground wire to the **GND** terminal ② on the device.
- 3 Connect the small ring end of the included 12V cable to the **+12V** terminal ③ on the device.
- 4 Tighten the $\frac{3}{8}$ in. nut on the +12V terminal to a maximum torque specification of 4.52 N-m (40 lbf-in.). You should confirm the nut cannot be loosened by hand.

NOTICE

Do not overtighten the +12V terminal to prevent damage to the terminal.

- 5 Connect the large ring end of the 12V cable ④ to the positive terminal on the vehicle battery.

Pairing with a Garmin Navigation Device

You can pair your Garmin PowerSwitch device with a compatible Garmin navigation device.

- 1 Turn on power to your Garmin PowerSwitch device, and place your compatible Garmin navigation device within 1 m (3.3 ft.) of it.
- 2 On your compatible navigation device, open the Garmin PowerSwitch app.
- 3 Follow the on-screen instructions to complete the pairing and setup process.

The main app dashboard appears. After the devices are paired, they connect automatically when they are turned on and within range.

Garmin PowerSwitch Specifications

Dimensions (D x W x H)	75 x 125 x 32 mm (2.95 x 4.92 x 1.26 in.)
Operating temperature range	From -25° to 85°C (from -13° to 185°F)
Wireless frequency	2.4 GHz @ +15 dBm
Power input	From 12 to 16 V using the included vehicle power cable.
Maximum accessory output	30 A
Maximum system output	100 A
Current draw with all outputs off	3 mA
Water rating	IEC 60529 IPX7 ¹

Troubleshooting

My Garmin PowerSwitch will not stay connected

- Verify the Garmin PowerSwitch device is receiving power.
- Verify that Bluetooth technology is enabled on your paired navigation device or smartphone.
- Move the navigation device or smartphone closer to your Garmin PowerSwitch device.
- Verify that your vehicle's battery is supplying at least 12 V of power.

The Garmin PowerSwitch device turns off all outputs automatically to preserve your vehicle's battery if it is receiving less than 11 V of power (*My accessories are not receiving power, page 72*).

My accessories are not receiving power

- Verify the Garmin PowerSwitch device is receiving power from the vehicle battery.
- Verify that your vehicle's battery is supplying at least 12 V of power.

The Garmin PowerSwitch device turns off all outputs automatically to preserve your vehicle's battery if it is receiving less than 11 V of power. Outputs turn back on when the device detects more than 12 V of power.

- Verify that all electrical connections are secure and will not come loose while operating the vehicle.
- Verify that each connected accessory draws less than 30 A.
If an accessory draws more than 30 A, the device turns off that output automatically.
- Verify that the total system load is less than 100 A.
If the device detects a system load of more than 100 A, it turns off all outputs automatically.
- Inspect all electrical connections for an electrical short circuit.

Wireless Cameras

Your device can display the video feed from one or more connected wireless cameras (sold separately).

¹ The device withstands incidental exposure to water of up to 1 m for up to 30 min. For more information, go to www.garmin.com/waterrating.

Pairing a BC™ 50 Backup Camera with a Garmin Navigation Device

Before you can connect to a camera you must enable the Wi-Fi setting on your Garmin navigation device.

The BC 50 wireless backup camera is compatible with some Garmin navigation devices with Android. Go to garmin.com/bc50 for more information about device compatibility.



You can pair up to four BC 50 wireless backup cameras with your compatible Garmin navigation device.

- 1 Update your navigation device to the latest software.

Your device may not support the BC 50 camera without the latest software. For more information about updating the software, see the owner's manual for your navigation device.

- 2 Turn on the Garmin navigation device, and bring it within 3 m (10 ft.) of the camera.

- 3 Place the vehicle in reverse to power the camera.

- 4 Select  > **Tools** > **Cameras** >  > **BC50**.

- 5 Select your BC 50 camera from the list of available cameras.

- 6 Position the guidance lines using the on-screen arrows.

If the camera or vehicle is not ideally positioned to complete the guidance line alignment, you can complete the alignment later.

- 7 Select **Save**.

After you complete the pairing process with a camera for the first time, the camera and navigation device connect automatically when they are turned on and within range.

Connecting a Wired Backup Camera

To connect a wired backup camera, you must use an optional video mount accessory, which includes a 3.5 mm composite video input jack. Go to garmin.com to purchase an accessory mount. The video mount accessory is included with some device models.

You can connect a wired backup camera and view the output on the device screen.

- 1 Replace the original device mount with the video mount accessory.
- 2 Plug the camera video cable into the video input jack  on the mount.



Viewing the Backup Camera

WARNING

This device is intended to enhance your situational awareness when used properly. If used improperly, you could become distracted by the display, which could lead to an accident causing serious personal injury or death. Only access the information displayed on the device with a glance. Always maintain awareness of your surroundings and do not stare at the display or become distracted by the display. Focusing on the display could prevent you from avoiding obstacles or hazards.

After you pair your camera with a compatible Garmin navigation device, the camera view appears automatically when you turn on your navigation device, and you can manually show the camera at any time.

- If your navigation device is connected to an ignition-switched power outlet (recommended), turn on your vehicle.
- If your navigation device is connected to an always-on power outlet, turn on the navigation device.
- To show the camera manually, select .
- To show or hide the camera using voice commands, say **Show Video** or **Hide Video**.

NOTE: Voice commands are not available on all navigation devices. The voice commands may vary based on your navigation device model. This feature is not available for all languages or may require additional navigation device setup for some languages. For more information, see the OK, Garmin app on your navigation device, or the navigation device owner's manual.

The camera view appears. When the camera detects the vehicle is moving forward, the camera automatically stops sending video, and the navigation device returns to normal operation. The camera video is dismissed automatically after 2 minutes and 30 seconds, whether or not your vehicle has moved forward.





Switching Cameras

When multiple backup cameras are transmitting to your device, you can switch between the views from the cameras.

- 1 Select  > **Tools** > **Cameras**.
- 2 Select a camera from the bottom of the screen.
The video feed from the camera appears.

Changing the Camera Orientation

Depending on where the camera is placed on your vehicle, the video on your device may appear upside down or mirrored by default. You can rotate the video horizontally or flip the video vertically to correct the video.

- 1 From the camera view, select an option:
 - Select  > **Adjust Video**.
 - Tap the screen, and select .
- 2 Select  to reverse the image or  to flip the image.
- 3 Select .

Connecting a Dash Camera to the Powered Mount

⚠ WARNING

It is your responsibility to ensure the mounting location complies with all applicable laws and ordinances, and does not block your view of the road to ensure safe operation of your vehicle.

Before you connect a dash camera to the powered mount, you should mount the dash camera device to your windshield.

You can use the dēzl device mount to power a compatible Garmin dash camera. This can be useful if you need to connect the dēzl device and the dash camera to the same power source in your vehicle.

- 1 Mount the dēzl device in your vehicle, and connect it to power (*Mounting and Powering the Device in Your Vehicle, page 2*).
- 2 If necessary, remove the dēzl device from the magnetic mount for a better view of the USB port.
- 3 Plug the dash camera's power cable into the USB port ① on the mount.



Data Management

The device has a memory card slot for additional data storage.

NOTE: The device is compatible with Windows 7 and newer, and Mac OS 10.7 and newer. Apple computers may require additional third-party software to read and write files.

About Memory Cards

You can purchase memory cards from an electronics supplier, or purchase pre-loaded Garmin mapping software (www.garmin.com). Memory cards can be used to store files such as maps and custom POIs.

Installing a Memory Card for Maps and Data

You can install a memory card to increase the storage space for maps and other data on your device. You can purchase memory cards from an electronics supplier. The device supports microSD memory cards from 4 to 256 GB. Memory cards must use the FAT32 file system format. Memory cards greater than 32 GB must be formatted using the device (*Formatting the Memory Card, page 76*).

- 1 Locate the map and data memory card slot on your device (*Device Overview, page 1*).
- 2 Insert a memory card into the slot.
- 3 Press it in until it clicks.

Formatting the Memory Card

The device requires a memory card formatted using the FAT32 file system. You can use the device to format your card using this file system.

You must format a brand new memory card if it is not formatted using the FAT32 file system.

NOTE: Formatting the memory card deletes all data on the card.

- 1 Select **Settings > Device > Storage & USB**.
- 2 Select your memory card.
- 3 Select **⋮ > Settings > Format > ERASE & FORMAT**.
- 4 Select **Done**.

Connecting the Device to Your Computer

You can connect the device to your computer using a USB cable.

- 1 Plug the small end of the USB cable into the port on the device.
- 2 Plug the larger end of the USB cable into a port on your computer.

Depending on your computer operating system, the device appears as either a portable device, a removable drive, or a removable volume.

Transferring Data From Your Computer

- 1 Connect the device to your computer (*Connecting the Device to Your Computer, page 76*).
Depending on your computer operating system, the device appears as either a portable device, a removable drive, or a removable volume.
- 2 On your computer, open the file browser.
- 3 Select a file.
- 4 Select **Edit > Copy**.
- 5 Browse to a folder on the device.
NOTE: For a removable drive or volume, you should not place files in the Garmin folder.
- 6 Select **Edit > Paste**.

Purchasing Additional Maps

- 1 Go to your device product page at garmin.com.
- 2 Click the **Maps** tab.
- 3 Follow the on-screen instructions.

Purchasing Accessories

- Optional accessories are available at garmin.com or from your Garmin dealer.

