

GARMIN®

ZÜMO® XT3

Motorcycle Navigator

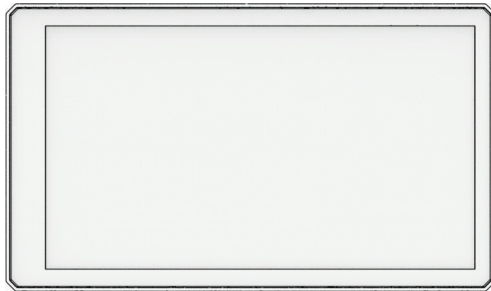

**Owner's
Manual**

Table of contents

Getting started.....	6	Searching for Helmet Laws.....	18
zūmo® XT3 - 6 in. Device Overview.....	6	Navigating to your destination.....	19
zūmo® XT3 - 4.7 in. Device Overview.....	6	Routes.....	19
Turning the device on or off.....	7	Starting a route.....	19
Locking and Unlocking the Touchscreen.....	7	Taking a Route Using Garmin Adventurous Routing™.....	19
Acquiring GPS signals.....	7	Starting a Route to a Point on the Map.....	19
Status bar icons.....	7	Going home.....	20
Using the on-screen buttons.....	7	Planning a Route.....	20
Adjusting the volume.....	8	Your route on the map.....	20
Using the audio mixer.....	8	Active lane guidance.....	21
Adjusting the screen brightness.....	8	Viewing turns and directions.....	21
Installation.....	9	Viewing the Entire Route on the Map.....	21
Mounting your device in a motorcycle.....	9	Arriving at your destination.....	21
Powered Motorcycle Mount.....	9	Parking Near Your Destination.....	22
Installing the Handlebar Base.....	10	Ride Summary.....	22
Installing the Post Mount.....	11	Changing Your Active Route.....	22
Installing your device in the motorcycle mount.....	12	Adding a location to your route.....	22
Removing Your Device from the Motorcycle Mount.....	12	Shaping your route.....	22
Mounting Your Device in a Vehicle.....	12	Taking a detour.....	22
Rider Awareness Features and Alerts.....	14	Stopping the route.....	23
Enabling or Disabling Rider Alerts.....	14	Avoiding Delays, Tolls and Areas.....	23
Red light and speed cameras.....	14	Avoiding traffic delays on your route.....	23
Incident Detection and Notifications... ..	14	Avoiding road features.....	23
Setting Up an Emergency Contact... ..	15	Avoiding toll roads.....	23
Cancelling an Incident Notification.....	15	Custom Avoidances.....	23
Disabling Incident Notifications.....	15	Fuel tracking.....	24
inReach® Remote.....	15	Enabling fuel tracking.....	24
Connecting an inReach® Device.....	15	Setting a low-fuel warning.....	24
SOS.....	15	Resetting the Fuel Tank Mileage.....	24
Garmin Messenger™ App.....	16	Enabling dynamic fuel stops.....	24
Using the Garmin Messenger App... ..	17	Using the Map.....	25
Creating a Post in the Garmin Messenger App.....	17	Map tools.....	25
Deleting Messages in the Garmin Messenger App.....	17	Viewing a map tool.....	25
Viewing Helmet Law Notifications.....	18	Up ahead.....	25
		Viewing upcoming locations.....	26
		Customising the up ahead categories.....	26
		Towns Ahead.....	26
		Viewing Upcoming Towns and Exit Services.....	26
		Trip information.....	26

Viewing trip data from the map.....	26
Viewing Trip Data.....	26
Resetting trip information.....	26
Viewing Traffic Information.....	27
Customising the map.....	27
Customising the map layers.....	27
Changing the map data field.....	28
Changing the Map Shortcuts.....	28
Changing the map perspective.....	28
Changing the Map Region.....	28

Finding and saving locations..... 29

Points of Interest.....	29
Finding a location using the search bar.....	29
Finding a location by category.....	29
Navigating to points of interest within a venue.....	30
Location Search Results.....	30
Changing the search area.....	30
Parking.....	31
Finding Parking Near Your Current Location.....	31
Finding Parking Near a Specified Location.....	31
Search tools.....	31
Finding an address.....	31
Finding a junction.....	31
Finding a location using coordinates.....	31
Finding National Parks.....	32
Finding Ultimate Campgrounds points of interest.....	32
Tripadvisor®.....	32
Finding Tripadvisor® points of interest.....	32
Trendy Places.....	32
Viewing history.....	33
Clearing the list of recently found places.....	33
Viewing current location information..	33
Finding emergency services and fuel.....	33
Getting directions to your current location.....	33
Adding a shortcut.....	33
Removing a shortcut.....	33

Saving Locations.....	33
Saving a location.....	33
Saving your current location.....	34
Editing a saved location.....	34
Viewing Your Saved Items.....	34
Sharing a Saved Item.....	34
Synchronising Garmin® Account Data.....	35

Vehicle Profiles..... 36

Switching the Vehicle Profile.....	36
Adding a vehicle profile.....	36
Editing a vehicle profile.....	36

Live services, traffic and smartphone features..... 37

Pairing with Your Smartphone.....	37
Pairing a wireless headset.....	37
Smart Notifications.....	37
Receiving notifications.....	37
Viewing the list of notifications.....	38
Hands-free calling.....	38
Placing a call.....	38
Using in-call options.....	39
Disconnecting a Bluetooth® device.....	39
Deleting a paired phone.....	39

Using the apps..... 40

Garmin Performance App.....	40
Subscribing to a Garmin Performance Package™.....	40
Starting a Track Session.....	41
Starting a Drag Race Session.....	42
Lean Angles.....	43
Garmin PowerSwitch™ App.....	43
Activating a Power Switch.....	43
Turning Off All Switches.....	43
Customising a Button.....	44
Assigning a Switch to a Control Input.....	44
Adding a Custom Layout.....	44
Routines.....	45
Radio.....	45
Selecting a Preset.....	45
Selecting a Radio Channel.....	46
Adjusting the Squelch.....	46
Adding a Custom Radio Preset.....	46

Selecting a Roger Tone.....	46
Turning the Radio Off.....	46
Enabling Push-to-Talk with a Headset.....	46
Transmitting Your Voice.....	46
Adjusting the Radio Volume.....	46
Radio Settings.....	47
Group Ride.....	47
Starting a Mobile Group Ride.....	47
Starting a Radio Group Ride.....	47
Joining a Group Ride.....	47
Rejoining a Recent Group Ride.....	47
Adding Riders to a Radio Group Ride.....	47
Broadcasting a Message.....	48
Broadcasting a Location.....	48
Viewing a Group Ride Notification... ..	48
Exiting a Group Ride.....	48
Group Ride Settings.....	48
Handlebar Controller.....	48
Configuring the Buttons.....	49
Wireless Cameras.....	49
Pairing the Device with a Wireless Camera.....	49
Viewing the Wireless Camera.....	49
Great Rides.....	50
Bookmarking a Ride.....	50
Synchronising Great Rides.....	50
Navigating a Bookmarked Ride.....	50
Music Player.....	51
Adding the Music Player Tool to the Map.....	51
Changing the Media Source.....	51
Tracks.....	51
Recording Tracks.....	51
TracBack®.....	52
Following your recent track.....	52
Saving Your Recent Track as a Route.....	52
Viewing traffic on the map.....	52
Searching for traffic incidents.....	52
Viewing the Weather Forecast.....	52
Viewing the weather radar.....	52
Viewing Previous Routes and Destinations.....	52

Settings.....53

Phone and Headset Settings.....	53
Phone settings.....	53
Headset Settings.....	53
Wi-Fi® settings.....	53
Map settings.....	53
Navigation settings.....	53
Traffic Settings.....	54
Setting a simulated location.....	54
Driver Assistance Settings.....	54
Display settings.....	54
System Settings.....	54
Position Format Settings.....	55
Setting the Time.....	55
Device and privacy settings.....	55
Enabling the Screen Lock.....	55
Restoring settings.....	55

Data management..... 56

About Memory Cards.....	56
Installing a memory card for maps and data.....	56
Connecting the Device to Your Computer.....	56
Transferring GPX Files From Your Computer.....	56
Transferring data from your computer.....	56
Disconnecting the USB cable.....	56

Device information..... 58

Viewing E-label Regulatory and Compliance Information.....	58
Specifications.....	58
Charging Requirements.....	0
Informações de Radiocomunicação.....	0
Charging the Device.....	58

Device maintenance..... 59

Garmin® Support Centre.....	59
Map and Software Updates.....	59
Updating Maps and Software Using a Wi-Fi® Network.....	59
Updating Maps and Software with Garmin Express™.....	60
Device Care.....	61
Cleaning the outer casing.....	61

Cleaning the Touchscreen..... 61
Restarting the Device..... 61

Troubleshooting..... 62

My device is not acquiring satellite
signals..... 62
My device does not connect to my
phone..... 62
My device is not contacting my
emergency contact..... 62
My battery does not stay charged for
very long..... 62
The suction cup will not stay on my
windscreen..... 62
My device does not appear as either a
portable device or a removable drive or
volume on my computer..... 62

Getting started

⚠ WARNING

See the *Important Safety and Product Information* guide in the product box for product warnings and other important information.

- 1 Connect to a Wi-Fi® network ([Connecting to a Wi-Fi® Network, page 59](#))(optional).
- 2 Pair your Bluetooth® phone and headset ([Pairing with Your Smartphone, page 37](#)) (optional).
- 3 Update the maps and software on your device ([Map and Software Updates, page 59](#)).
- 4 Acquire GPS signals ([Acquiring GPS signals, page 7](#)).
- 5 Mount the device and connect it to power ([Installation, page 9](#)).
- 6 Adjust the screen brightness ([Adjusting the screen brightness, page 8](#)).
- 7 Navigate to your destination ([Starting a route, page 19](#)).

zūmo® XT3 - 6 in. Device Overview

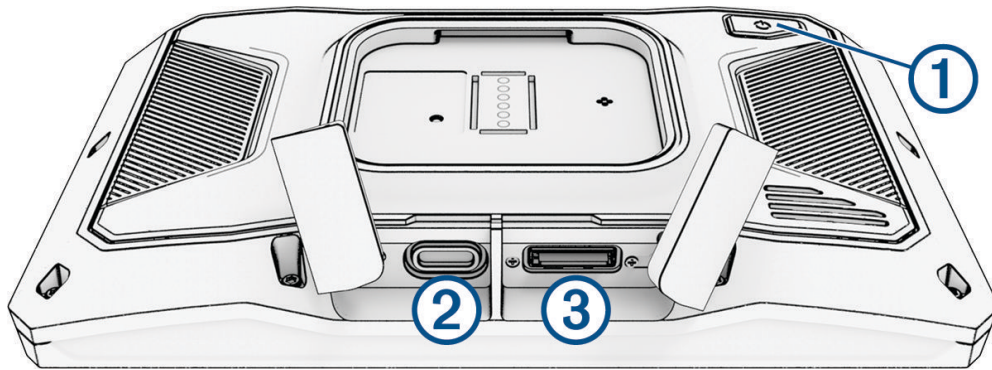

①	Power button
②	USB-C® power and data port
③	microSD® memory card slot

zūmo® XT3 - 4.7 in. Device Overview

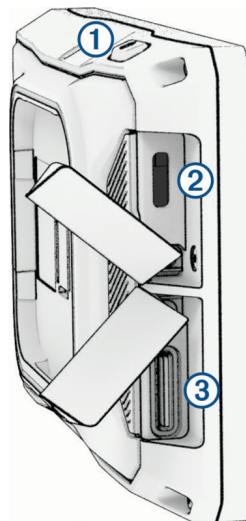

①	Power button
②	USB-C® power and data port
③	microSD® memory card slot

Turning the device on or off

- To turn the device on, press the power button or connect the device to power.
- To put the device in power saving mode, press the power button while the device is on.
While in power saving mode, the screen is off and the device uses very little power, but it can wake instantly for use.
TIP: you can charge your device faster by putting it in power saving mode while charging the battery.
- To turn off the device completely, hold the power button until a prompt appears on the screen and select **Power Off**.
The prompt appears after five seconds. If you release the power button before the prompt appears, the device enters power saving mode.

Locking and Unlocking the Touchscreen



You can lock the touchscreen to prevent unwanted interaction during your ride. This can be useful during rain and other environmental situations that may affect the touchscreen.

- To lock the touchscreen, hold the power button until a prompt appears on the screen, and select **Lock Screen**.
The prompt appears after five seconds. If you release the power button before the prompt appears, the device enters power saving mode.
- To unlock the touchscreen, press the power button.

Acquiring GPS signals











When you turn on your navigation device, the GPS receiver must collect satellite data and establish the current location. The time required to acquire satellite signals varies based on several factors, including how far you are from the location where you last used your navigation device, whether you have a clear view of the sky, and how long it has been since you last used your navigation device. The first time you turn on your navigation device, it may take several minutes to acquire satellite signals.

- 1 Turn on the device.
- 2 Wait while the device locates satellites.
- 3 If necessary, go to an open area away from tall buildings and trees.

 in the status bar indicates the satellite signal strength. When at least half of the bars are filled, the device is ready for navigation. You can touch the  icon to view more details about your satellite signal, such as your current location accuracy.





Status bar icons



The status bar is located at the top of the main menu. The status bar icons display information about features on the device. You can select some icons to change settings or view additional information.

	GPS signal status. Select to view GPS accuracy and acquired satellite information .
	Bluetooth® technology status. Select to view the Bluetooth settings (Phone and Headset Settings, page 53).
	Wi-Fi® signal strength. Select to change the Wi-Fi settings (Wi-Fi® settings, page 53).
	Connected to hands-free calling. Select to place a phone call (Hands-free calling, page 38).
	Active vehicle profile. Select to view the vehicle profile settings.
	Current time. Select to set the time (Setting the Time, page 55).
	Battery charge level.
	Tread® app connection status (Pairing with Your Smartphone, page 37).
	Temperature. Select to view the weather forecast (Viewing the Weather Forecast, page 52).
	Fuel status. Select to view fuel tracking information (Fuel tracking, page 24).



Using the on-screen buttons

On-screen buttons allow you to navigate the pages, menus and menu options on your device.

- Select  to return to the previous menu screen.
- Hold  to quickly return to the main menu.
- Select  or  to scroll through lists or menus.

- Hold  or  to scroll faster.
- Select  to see a context-based menu of options for the current screen.

Adjusting the volume

- 1 Select .
- 2 Select an option:
 - Use the slider bar to adjust the volume.
 - Select  to mute the device.
 - Select a tick box to enable or disable additional sound options.

Using the audio mixer

You can use the audio mixer to set the volume levels for different audio types, such as navigation prompts or phone calls. The level for each audio type is a percentage of the master volume.

- 1 Select .
- 2 Select **Audio Mixer**.
- 3 Use the sliders to adjust the volume for each audio type.

Adjusting the screen brightness

- 1 Select  > **Display**.
- 2 Use the slider bar to adjust the brightness.

Installation

Mounting your device in a motorcycle

Powered Motorcycle Mount

⚠ WARNING

See the *Important Safety and Product Information* guide in the product box for product warnings and other important information.

Garmin® strongly recommends having an experienced installer with the proper knowledge of electrical systems install the device. Incorrectly wiring the power cable can result in damage to the vehicle, the battery or the device and can cause bodily injury.

NOTICE

Do not disassemble the device or motorcycle mount, because doing so could damage the device or mount.

The device must be mounted in a suitable and secure location on your motorcycle, based on available power sources and safe cable routing.

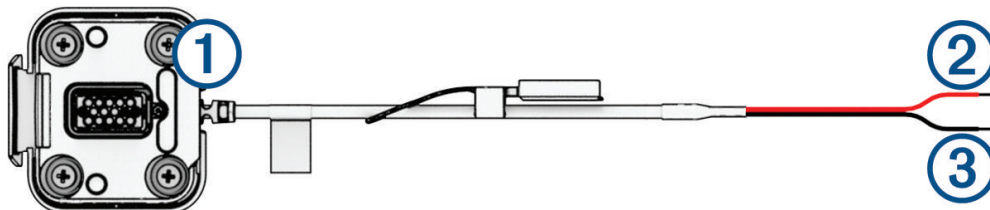

①	Motorcycle mount connector
②	10 to 30 Vdc system power (red)
③	System ground (black)

NOTE: additional parts are included with the device to provide more installation and wiring options. Contact an experienced installer for more information about using these parts with your motorcycle.

Crimp-Style Ring Terminal: connects the wiring harness directly to the battery terminal.

Cable Tie: secures cables to the motorcycle frame.

In-line Fuse Cable: protects the navigation device from excessive electrical current (*In-line Fuse Cable*, page 9).

In-line Fuse Cable

⚠ WARNING

Garmin® strongly recommends getting an experienced installer with a proper knowledge of electrical systems to install the in-line fuse cable. Incorrectly wiring the power cable or the in-line fuse cable can result in damage to the vehicle or the battery and can cause bodily injury.

In many cases, you must install the included in-line fuse cable on the device power cable to protect the device from excessive electrical current.

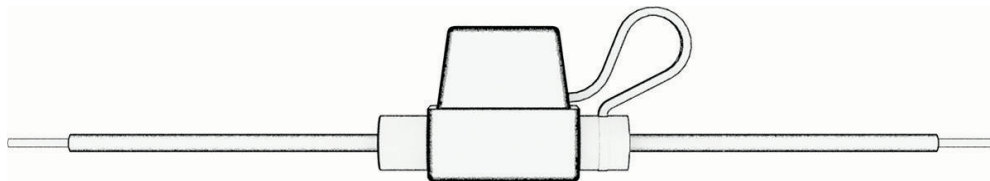

- You must install the included in-line fuse cable if you are connecting the power cable directly to the vehicle battery.
- If you are connecting the power cable to an accessory power source or bus bar that already has a suitable fuse or a protective circuit, installing the included in-line fuse is not necessary.
- When installing the in-line fuse cable, you should connect it to the red system power wire using the included splice connector.

Installing the Handlebar Base

The zūmo® XT3 - 6 in. device includes parts for two handlebar installation solutions. Custom mounts may require additional hardware.

Installing the U-bolt and Handlebar Base

- 1 Place the U-bolt ① around the handlebar ②, and thread the ends through the handlebar base ③.

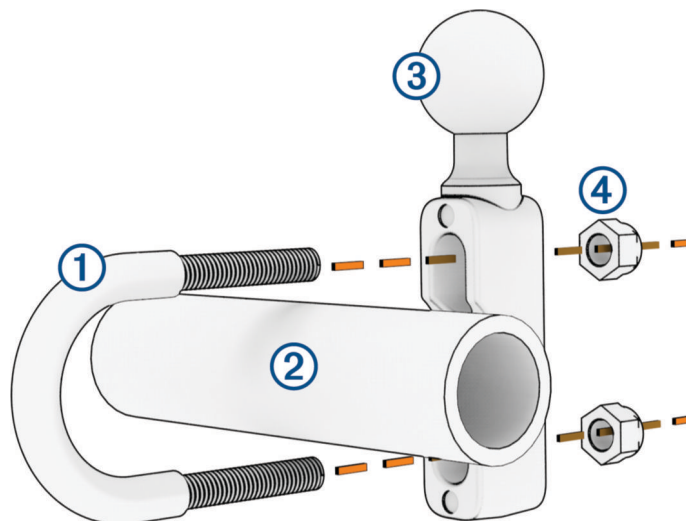

- 2 Tighten the nuts ④ to secure the base.
the recommended torque is 5.65 N-m (50 lbf-in). Do not exceed a torque of 9.04 N-m (80 lbf-in).

Installing the Handlebar Base to the Clutch-Clamp or Brake-Clamp Brackets

- 1 Remove the two factory bolts on your clutch-clamp or brake-clamp bracket ①.

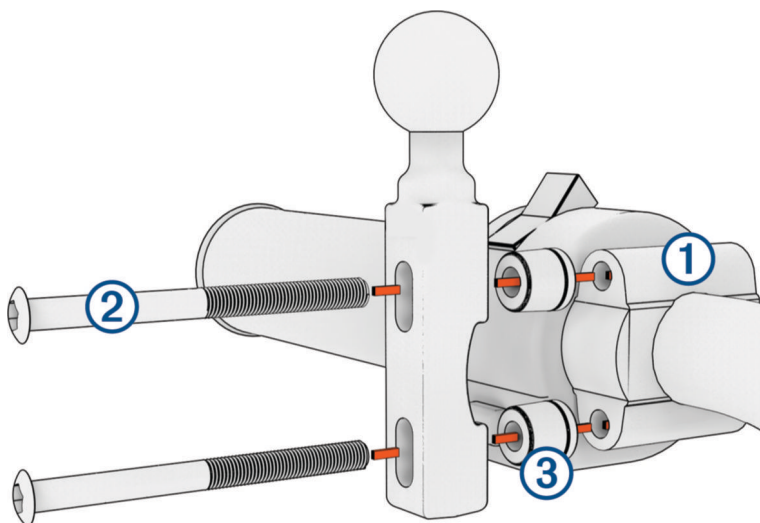

NOTE: both $\frac{1}{4}$ in. standard and M6 bolts are included. Match the size of the factory bolts on your clutch-clamp or brake-clamp bracket.

- 2 Thread the new bolts ② through the handlebar base, spacers ③, and clutch-clamp or brake-clamp bracket.
- 3 Tighten the bolts to secure the handlebar base.

Attaching the Base Plate to the Handlebar Base

- 1 Align the ball of the handlebar base ① and the ball of the base plate ② with each end of the double-socket arm ③.

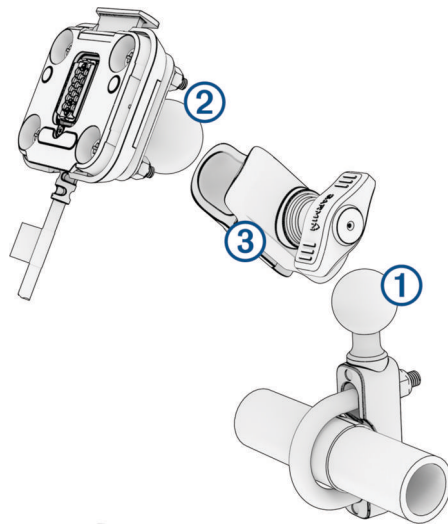

- 2 Insert the ball of the handlebar base ① and the ball of the base plate ② into the double-socket arm ③.
- 3 Tighten the knob slightly.
- 4 Adjust for optimal viewing and operation.
- 5 Tighten the knob to secure the mount.

Installing the Post Mount

The zūmo® XT3 - 4.7 in. device includes parts for a post mount installation. Custom mounts may require additional hardware.

- 1 Remove a factory bolt on your handlebar ①.

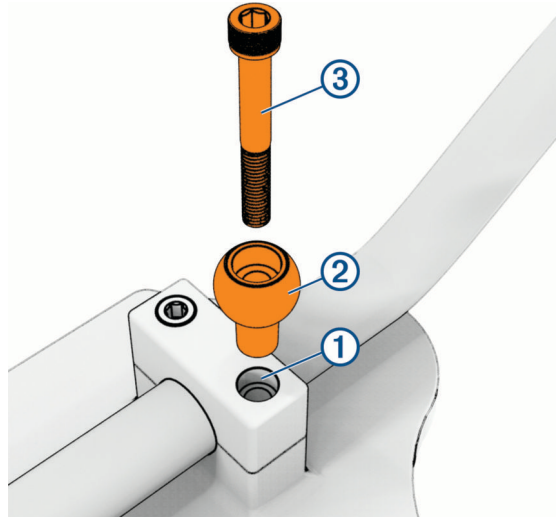

- 2 Insert the post mount ② into the handlebar and insert the new bolt ③ through the post mount.
NOTE: m8 bolts are included in 50mm, 55mm and 60mm lengths. Match the size of the factory bolt on your handlebar.
- 3 Tighten the bolt to secure the post mount.

Attaching the Base Plate to the Post Mount

- 1 Insert the ball of the post mount ① and the ball of the base plate ② into the double-socket arm ③.

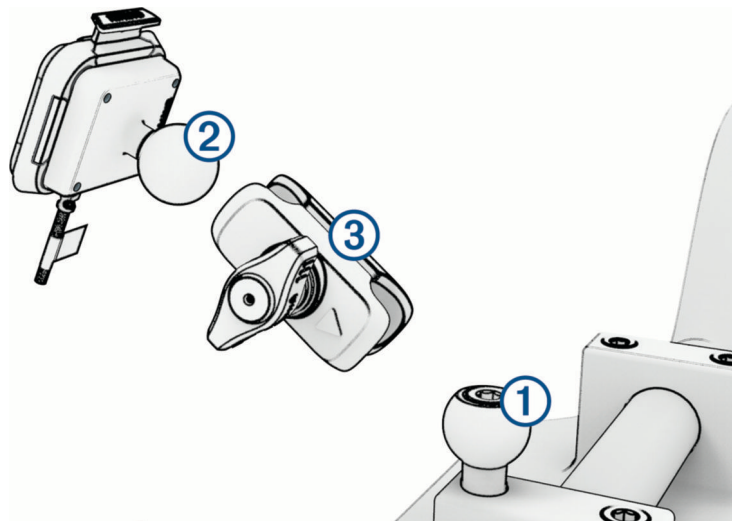

- 2 Tighten the knob slightly.
- 3 Adjust for optimal viewing and operation.
- 4 Tighten the knob to secure the mount.

Installing your device in the motorcycle mount

- 1 Fit the bottom of your device into the cradle.

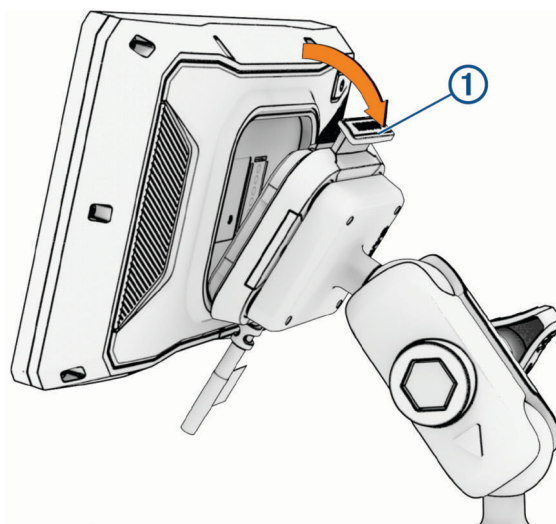

- 2 Push the top of the device forward until it snaps into place.
The latch ① on the mount stays up after you have inserted the device.

Removing Your Device from the Motorcycle Mount

- 1 Press the latch on the top of the mount.
- 2 Lift out the device.

Mounting Your Device in a Vehicle

⚠ WARNING

See the *Important Safety and Product Information* guide in the product box for product warnings and other important information.

This product contains a lithium-ion battery. To prevent the possibility of personal injury, product damage or other property damage caused by battery exposure to extreme heat, store the device out of direct sunlight.

Do not use the suction cup mount on a motorcycle.

NOTICE

Before mounting the device, check the local laws pertaining to windscreen mounting.

NOTE: the vehicle mount is an optional accessory. Go to garmin.com to purchase optional accessories.

- 1 Plug the automotive power cable ① into the port ② on the device.

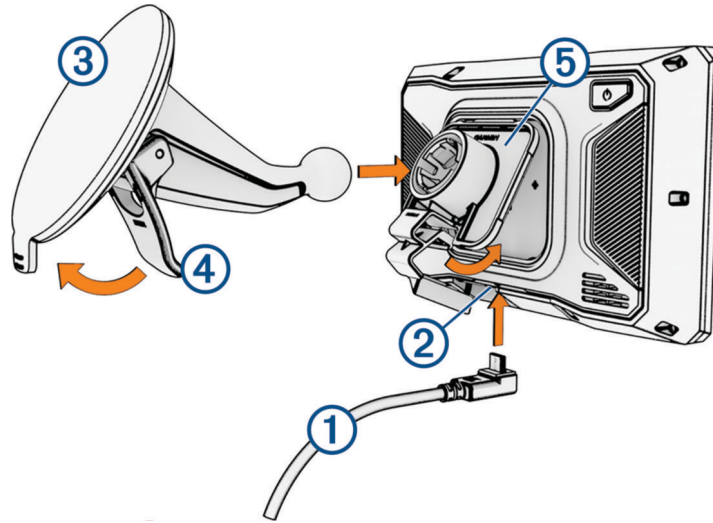

- 2 Remove the clear plastic from the suction cup ③.
- 3 Clean and dry your windscreen and the suction cup with a lint-free cloth.
- 4 Press the suction cup to the windscreen, and flip the lever ④ back toward the windscreen.
- 5 Snap the cradle ⑤ onto the suction-cup arm.
- 6 Fit the top of your device into the cradle.
- 7 Press the device into the cradle until it snaps into place.
- 8 Plug the other end of the automotive power cable into a power outlet.

Rider Awareness Features and Alerts

⚠ CAUTION

The rider alerts and speed limit features are for information only and do not replace your responsibility to abide by all posted speed limit signs and to use safe driving judgement at all times. Garmin® is not responsible for any traffic fines or citations that you receive for failing to follow all applicable traffic laws and signs.

Your device provides features that can help encourage safer riding, even when you are riding in a familiar area. The device plays an audible tone or message and displays information for each alert. You can enable or disable the audible tone or message for each type of alert. Not all alerts are available in all areas.

School zone or nearby school: the device plays a tone and displays the distance to and speed limit (if available) for an upcoming school or school zone.

Speed limit reduction: the device plays a tone and displays the upcoming reduced speed limit so you can be prepared to reduce your speed.

Speeding alert: the device displays a red border on the speed limit icon when you exceed the posted speed limit for the current road.

Level crossing: the device plays a tone and displays the distance to an upcoming level crossing.

Animal crossing: the device plays a tone and displays the distance to an upcoming animal crossing area.

Curve: the device plays a tone and displays the distance to a curve in the road.

Slower traffic: the device plays a tone and displays the distance to slower traffic when you approach slower traffic at a higher speed. Your device must be receiving traffic information to use this feature.

Break planning: the device plays a tone and suggests upcoming rest stops after you have been driving for more than two hours without stopping.

Enabling or Disabling Rider Alerts

You can turn off individual audible rider alerts. Visual alerts appear even when the audible alert is disabled.

- 1 Select  > **Driver Assistance** > **Rider Alerts**.
- 2 Select or clear the tick box next to each alert.

Red light and speed cameras

NOTICE

Garmin® is not responsible for the accuracy of or the consequences of using a red light or speed camera database.

NOTE: this feature is not available for all regions or product models.

Information about red light and speed camera locations is available in some areas and for some product models with a paid subscription. The device alerts you when you approach a reported speed or red light camera.

- In some areas, your device can receive red light and speed camera data while connected to a smartphone running the Tread® app.
- You can use the Garmin Express™ software (garmin.com/express) or the Tread app to update the camera database stored on your device. You should update your device frequently to receive the most up-to-date camera information.

Incident Detection and Notifications

⚠ WARNING

The device allows you to send your location to an emergency contact. This is a supplementary feature and should not be relied upon as a primary method to obtain emergency assistance. The Tread® app does not contact emergency services on your behalf.

NOTICE

To use this feature, your device must be connected to the Tread app using Bluetooth® technology. You can set emergency contacts using the Tread app.

To use this feature, your device must be connected to a compatible external power source using the included mount or a USB cable.

Your zūmo® device uses built-in sensors to detect a possible vehicle incident.

- If you set up an emergency contact, the device can send an automated text message to that contact when it detects an incident and your vehicle stops moving. This can help alert the contact to your situation if you are

not able to call or send a message. This feature requires your device to be connected to the Tread app using Bluetooth technology and your phone to have an active mobile data connection to send a message.

- If you have not set up an emergency contact, the device automatically displays the nearest address or geographic coordinates, if available, when it detects an incident. This feature is helpful if you need to tell emergency personnel your location.
- If you have an inReach® satellite communicator connected to your zūmo device, you can manually send an SOS when your zūmo device detects an incident.

Setting Up an Emergency Contact

Before you can set up an emergency contact, you must connect your navigation device to the Tread® app ([Pairing with Your Smartphone, page 37](#)).

The device must have access to the Tread app and to your smartphone phone book during the emergency contact setup. An emergency contact must be an existing contact on the smartphone paired with your zūmo® device.

1 From the Tread app on your smartphone, select  > **Settings** > **Emergency Assistance** > **Continue**.

2 Read and accept the terms of use.

NOTE: you must accept the terms of use to use this feature.

3 Select **Add Emergency Contact**.

A list of your smartphone contacts appears.

4 Select a contact.

5 Select **Import** > **Save**.

6 Follow the on-screen instructions to inform your contact that you have added them as an emergency contact.

NOTE: the incident notification message includes the name or nickname you entered, but it is not sent from your phone number. The message is sent using a third-party service, and you should inform your emergency contact that the incident message will come from an unknown number.

Cancelling an Incident Notification

When the device detects an incident, a message and a voice prompt inform you that a notification will be sent to your emergency contact. A 60-second countdown timer starts when the incident is detected, and the device sends the notification automatically when the timer expires. If you do not want to send the notification, you can cancel it.

Before the timer expires, select **Cancel**.

Disabling Incident Notifications

While incident notifications are disabled, the device does not send an SMS notification when it detects an incident.

1 Select  > **Driver Assistance**.

2 Clear the **Automatic Incident Detection** tick box.

inReach® Remote

The inReach remote function allows you to control your inReach satellite communication device (sold separately) using your zūmo® device. You can send messages, view weather reports, trigger an SOS alert and more. Go to buy.garmin.com to purchase an inReach device.

Connecting an inReach® Device

1 Bring the inReach device within 3 m (10 ft.) of your zūmo® device.

2 On your zūmo device, select  > **inReach**.

3 Follow the on-screen instructions on your zūmo device to complete the pairing process.

After the pairing process is complete, the inReach and zūmo devices connect automatically when they are within range.

SOS

WARNING

Before you can use the SOS function, you must have an active satellite subscription. Always test your device before you use it outdoors.

Ensure that you have a clear view of the sky when using the SOS function, because this feature requires satellite access to operate properly.

NOTICE

Some jurisdictions regulate or prohibit the use of satellite communications devices. It is the responsibility of the user to know and follow all applicable laws in the jurisdictions where the device is intended to be used.

During an emergency, you can use your paired inReach® satellite communicator to contact the Garmin ResponseSM centre to request help. The SOS feature sends a message to the Garmin Response team and they notify the appropriate emergency responders of your situation. You can communicate with the Garmin Response team during your emergency while you wait for help to arrive. You should only use the SOS function in a real emergency situation.

Initiating an SOS Rescue

⚠ WARNING

Before you can initiate an SOS rescue using your zūmo® navigator, you must pair it with a compatible inReach® satellite communicator ([Connecting an inReach® Device, page 15](#)).

⚠ CAUTION

While the device is in SOS mode, do not turn off or attempt to turn off the inReach satellite communicator. Doing so could prevent this feature from operating properly and could delay receipt of assistance in the event of an emergency.

1 Select  > **inReach**.

2 Select .

3 Wait for the SOS countdown.

The device sends a default message to the emergency response service with details about your location.

4 Reply to the confirmation message from the emergency response service.

Your reply lets the emergency response service know that you are capable of interacting with them during the rescue.

For the first 10 minutes of your rescue, an updated location is sent to the emergency response service every minute. To conserve battery power after the first 10 minutes, an updated location is sent every 10 minutes when moving and every 30 minutes when stationary.

Cancelling an SOS Rescue

If you no longer need assistance, you can cancel an SOS rescue after it is sent to the emergency response service.

Select **Cancel SOS**.

Your device transmits the cancellation request. When you receive a confirmation message from the emergency response service, the device returns to normal operation.

Garmin Messenger™ App

⚠ WARNING

The inReach® features of the Garmin Messenger app on your phone, including SOS, tracking and inReach™ Weather, are not available without a connected inReach device and an active inReach service plan. Always test the app outdoors before using it on a trip.

⚠ CAUTION

The non-satellite messaging features of the Garmin Messenger app on your phone should not be solely relied upon as a primary method to obtain emergency assistance.

NOTICE

The app works over both the internet (using a wireless connection or mobile data on your phone) and the satellite network (using an inReach device). If you are using mobile data, your paired phone must be equipped with a data plan and be in an area of network coverage where data is available. If you are in an area without network coverage, you must have an active inReach service plan for your device to use the satellite network.

You can use the app to message other Garmin Messenger app users, including friends and family without Garmin® devices. Anyone can download the app and connect their phone, allowing them to communicate with other app users over the internet (no login is required). App users can also create group messaging threads

with other SMS phone numbers. New members added to the group message can download the app to see what others are saying.

Messages sent using a wireless connection or mobile data on your phone do not incur data charges or additional charges on your inReach service plan. Messages received may incur charges if message delivery is attempted over both the satellite network and the internet. Standard text messaging rates for your mobile data plan apply.

You can download the Garmin Messenger app from the app store on your phone (garmin.com/messengerapp).

Using the Garmin Messenger App

⚠ CAUTION

The non-satellite messaging features of the Garmin Messenger™ app alone should not be relied on as a primary method to obtain emergency assistance.



NOTICE

To use the Garmin Messenger app on your zūmo® navigator, it must be connected to the zūmo app and the Garmin Messenger app on your compatible phone using Bluetooth® technology (*Garmin Messenger™ App*, page 16).

The Garmin Messenger app on your navigator allows you to view, compose and reply to messages from the Garmin Messenger app on your phone.

- 1 From the home screen, select  > **Garmin Messenger**.
- 2 If this is your first time using the **Garmin Messenger** feature, scan the QR code with your phone and follow the on-screen instructions to complete the pairing and setup process.
- 3 On your navigator, select an option:
 - To compose a new message, select **New Message**, select one or more recipients, select **Next** and compose a message.
 - To view a conversation, scroll down and select a conversation.
 - To reply to a message, select a conversation, select **Reply** and compose a message.

TIP: you can select  to send a message with your current location.





 - To share a location, select  > **Location**, search for a location and select **Select** to add it to the message.
 - To send an automated message with your arrival time while navigating to a destination, select  > **Arrival Time**.

Creating a Post in the Garmin Messenger App



⚠ CAUTION

The non-satellite messaging features of the Garmin Messenger™ app alone should not be relied on as a primary method to obtain emergency assistance.

You can send a post message to multiple recipients at once, where each recipient receives the message individually without seeing replies from others. Messages sent to more than five contacts, or to email addresses and zūmo® addresses, are sent as post messages.

- 1 From the home screen, select  > **Garmin Messenger**.
 - 2 Select  > **Create a New Post**.
 - 3 Select one or more recipients.
 - 4 Select **Next**.
 - 5 Compose a message.
- TIP:** you can select  to send a message with your current location. You can select  to share a location or send an automated message with your arrival time while navigating.

Deleting Messages in the Garmin Messenger App

- 1 From the home screen, select  > **Garmin Messenger**.
- 2 Select an option:
 - To delete an individual message, select a conversation, select a message and select **Delete**.
 - To delete an entire message thread, select  > **Delete Messages**, select a message thread and select **Delete**.

Viewing Helmet Law Notifications

While you are using a motorcycle vehicle profile, helmet law and eye protection notifications may appear on your zūmo® device. Notifications appear the first time your device acquires satellites and when your device approaches a location with motorcycle safety rules.

NOTICE

Garmin® recommends that all riders wear helmets for safety. Helmet law notifications are for reference only, are subject to change and are not intended to be considered legal advice. Helmet law notifications are available in the U.S. and Canada only.

Select the notification to view more details.

Searching for Helmet Laws

You can search for helmet laws by state or province.

- 1 Select  > **Helmet Guide**.
- 2 Select a county or province.

Navigating to your destination

Routes

A route is a path from your current location to one or more destinations.

- The device calculates a recommended route to your destination based on the preferences you set, including the route calculation mode and avoidances ([Avoiding Delays, Tolls and Areas, page 23](#)).
- You can start navigating to your destination quickly using the recommended route, or you can select an alternative route ([Starting a route, page 19](#)).
- If there are specific roads you need to use or avoid, you can customise the route.
- You can add multiple destinations to a route ([Adding a location to your route, page 22](#)).

Starting a route

You can start a route by searching for a location.

- 1 Select **Where To?** and search for a location.
- 2 Select a location.
- 3 Select an option:
 - To navigate using the default route calculation method for the current vehicle profile, select **Go!**.
 - To navigate to the location using adventurous routing ([Taking a Route Using Garmin Adventurous Routing™, page 19](#)), select .

The device calculates a route to the location and guides you using voice prompts and information on the map ([Your route on the map, page 20](#)). A preview of the major roads in your route appears at the edge of the map for several seconds.

If you need to stop at additional destinations, you can add the locations to your route ([Adding a location to your route, page 22](#)).



Taking a Route Using Garmin Adventurous Routing™

Your device can calculate adventurous routes that prefer curvy roads, hills and fewer motorways. This feature can provide a more enjoyable ride, but it may increase the time or distance to your destination.

- 1 Select **Where To?**, and search for a location.
- 2 Select a location.
- 3 Select .
- 4 Use the slider to increase or decrease the level of adventure of your route.
- 5 Select **Go!**.

Changing Adventurous Route Settings

You can add and remove some types of paths, roads and environmental features from adventurous routes.

- 1 Select **Where To?** and search for a location.
- 2 Select a location.
- 3 Select  > .
- 4 Select or remove one or more route features, and select .

The navigator recalculates the route with the selected route features.

Changing the Level of Adventurous Routing

You can change the level of adventurous routing without starting a new route.

- 1 From the map, select  > **Edit Route** > **Garmin Adventurous Routing™**.
- 2 Use the slider to increase or decrease the level of adventure for your route.
- 3 Select **Go!**.

Starting a Route to a Point on the Map

You can start a route by selecting a location from the map.

- 1 Select **View Map**.
- 2 Drag and zoom the map to display the area.
- 3 Select a point on the map.
- 4 Select **Go!**.

The device calculates a route using the default calculation method for your vehicle profile.

Going home

The first time you start a route home, the device prompts you to enter your home location.

- 1 Select **Where To? > Go Home**.
- 2 If necessary, enter your home location.

Editing your home location

- 1 Select **Where To? > ≡ > Set Home Location**.
- 2 Enter your home location.

Planning a Route

A route can include many stops and shaping points, and it must include at least a starting location and one destination.

- 1 Select **≡ > Route Planner**.
- 2 Search for or select a location on the map to be the starting point for this route.
- 3 If necessary, select a route calculation mode for the route segment.
TIP: you can select **⚡** to let the device automatically calculate the most adventurous route to your next destination ([Taking a Route Using Garmin Adventurous Routing™](#), page 19).
- 4 Select an option:
 - If the next point along your route is a stop, select **Add a Stop**.
 - If the next point in your route is a shaping point, select **Add Shaping Point**.
- 5 If necessary, add additional stops or shaping points.
the last stop you add is the route destination.
- 6 If necessary, select **≡** to rearrange the order of stops and shaping points along the route.
- 7 After you have finished planning the route, select **📄**.

Your route on the map

As you travel, the device guides you to your destination using voice prompts and information on the map. Instructions for your next turn or exit, or other actions appear across the top of the map.

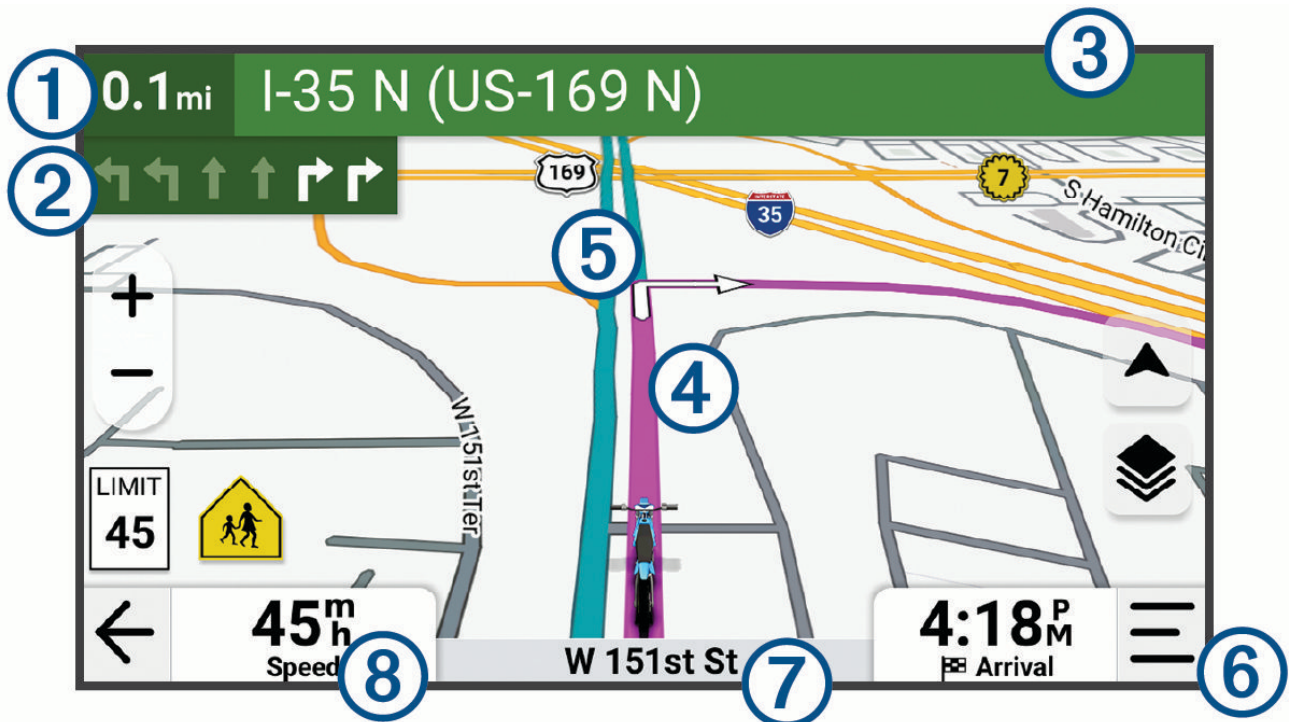

①	Distance to the next action.
②	Next action in the route. Indicates the next turn, exit, or other action and the lane in which you should travel, if available.
③	Name of the street or exit associated with the next action.
④	Route highlighted on the map.
⑤	Next action in the route. Arrows on the map indicate the location of upcoming actions.
⑥	Map tools. Provides tools to show you more information about your route and surroundings.
⑦	Name of the road on which you are travelling.
⑧	Vehicle speed.

Active lane guidance

As you approach some turns, exits, or interchanges in your route, a detailed simulation of the road appears beside the map, if available. A coloured line ① indicates the proper lane for the turn.

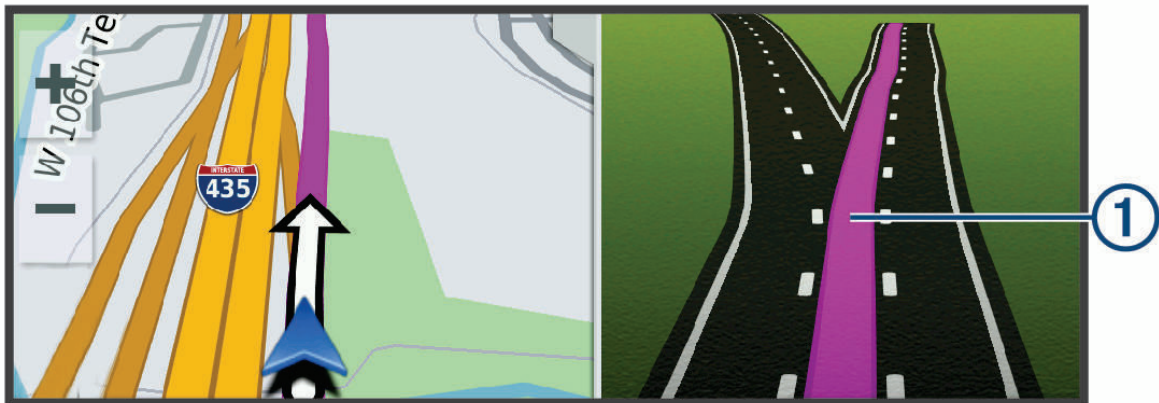

Viewing turns and directions

While navigating a route, you can view next turns, lane changes, or other directions for your route.

1 From the map, select an option:

- To view next turns and directions as you navigate, select > **Turns**. The map tool displays the next several turns or directions beside the map. The list updates automatically as you navigate the route.
- To view the complete list of turns and directions for the entire route, select the text bar at the top of the map.

2 Select a turn or direction (optional).

Detailed information appears. An image of the junction may appear for junctions on major roads, if available.

Viewing the Entire Route on the Map

1 While navigating a route, select anywhere on the map.

2 Select .

Arriving at your destination

When you approach your destination, the device provides information to help you complete your route.

- indicates the location of your destination on the map, and a voice prompt announces you are approaching your destination.
- When you approach some destinations, the device automatically prompts you to search for parking. You can select Yes to find nearby parking areas (*Parking Near Your Destination*, page 22).
- When you stop at your destination, the device automatically ends the route. If the device does not detect your arrival automatically, you can select Stop to end your route.

Parking Near Your Destination

NOTICE

This feature is for informational purposes only. You are responsible for ensuring that you are parking in accordance with posted signage and any applicable laws, regulations or rules that may apply to your desired parking location.

Your device can help you find a parking spot near your destination. When you approach some destinations, the device automatically suggests parking areas.

1 Select an option:

- When the device suggests parking, select **More** to see all of the suggested parking areas. when you select a suggested parking area, the device automatically updates your route.
- If the device does not suggest parking locations, select **Where To? > Categories > Parking** and select **Near Destination** for the search area.

2 Select a parking location and select **Go!**.

The device guides you to the parking area.

Ride Summary

When you arrive at your destination, the device displays a summary of your ride statistics. You can select Save to save the ride as a track.

NOTE: you can disable the ride summary in the settings menu (*Driver Assistance Settings, page 54*).

Changing Your Active Route

Adding a location to your route

Before you can add a location to your route, you must be navigating a route (*Starting a route, page 19*).

You can add locations to the middle or end of your route. For example, you can add a petrol station as the next destination in your route.

TIP: to create complex routes with multiple destinations or scheduled stops, you can use the route planner to plan, schedule and save a route (*Planning a Route, page 20*).

1 From the map, select **← > Where To?**.

2 Search for a location.

3 Select a location.

4 Select **Go!**.

5 Select an option:

- To add the location as the next destination in your route, select **Add as Next Stop**.
- To add the location to the end of your route, select **Add as Last Stop**.
- To add the location and edit the order of destinations in your route, select **Add to Active Route**.

The device re-calculates the route to include the added location and guides you to the destinations in order.

Shaping your route

Before you can shape your route, you must start a route (*Starting a route, page 19*).

You can manually shape your route to change its course. This allows you to direct the route to use a certain road or go through a certain area without adding a destination to the route.

1 From the map, select **≡ > Edit Route > Shape Route**.

The device enters route shaping mode.

2 Select a map location to create a shaping point.

TIP: you can select **+** to zoom in on the map and select a more precise location.

3 If necessary, select an option:

- To add more shaping points to the route, select additional locations on the map.
- To remove a shaping point, select the shaping point and select **✖**.

4 Select **✓**.

Taking a detour

You can take a detour for a specified distance along your route or detour around specific roads. This is useful if you encounter construction zones, closed roads or poor road conditions.

- 1 From the map, select  > **Edit Route**.
- 2 Select an option:
 - To re-route for a specific distance, select **Detour by Distance**.
 - To detour around a specific road on the route, select **Detour by Road**.

Stopping the route

From the map, select  > **Stop**.

Avoiding Delays, Tolls and Areas

Avoiding traffic delays on your route

Before you can avoid traffic delays, you must be receiving traffic information.

By default, the device optimises your route to avoid traffic delays automatically. If you have disabled this option in the traffic settings (*Traffic Settings, page 54*), you can view and avoid traffic delays manually.

- 1 While navigating a route, select  > **Traffic**.
- 2 Select **Alternative Route**, if available.
- 3 Select **Go!**.

Avoiding road features

- 1 Select  > **Navigation**.
- 2 Select the vehicle profile.
- 3 Select **Avoidances**.
- 4 Select the road features to avoid on your routes and select **Save**.

Avoiding toll roads

Your device can avoid routing you through areas that require tolls, such as toll roads, toll bridges, or congestion areas. The device may still include a toll area in your route if no other reasonable routes are available.

- 1 Select  > **Navigation**.
- 2 Select the vehicle profile.
- 3 Select **Avoidances > Tolls and Fees**.
- 4 Select **Save**.

Custom Avoidances

Custom avoidances allow you to select specific areas or sections of road to avoid. When the device calculates a route, it avoids these areas and roads unless no other reasonable route is available.

Avoiding an area

- 1 Select  > **Navigation > Custom Avoidances**.
- 2 If necessary, select **Add Avoidance**.
- 3 Select **Add Avoid Area**.
- 4 Select the upper left corner of the area to avoid and select **Next**.
- 5 Select the lower right corner of the area to avoid and select **Next**.
The selected area is shaded on the map.
- 6 Select **Done**.

Avoiding a road

- 1 Select  > **Navigation > Custom Avoidances**.
- 2 If necessary, select **Add Avoidance**.
- 3 Select **Add Avoid Road**.
- 4 Select the starting point of the section of road to avoid and select **Next**.
- 5 Select the ending point of the road section and select **Next**.
- 6 Select **Done**.



Disabling a custom avoidance

You can disable a custom avoidance without deleting it.

- 1 Select  > **Navigation > Custom Avoidances**.

- 2 Select a created avoidance.
- 3 Select  > **Disable**.

Deleting custom avoidances

- 1 Select  > **Navigation** > **Custom Avoidances** > .
- 2 Select an option:
 - To delete all custom avoidances, select **Select All** > **Delete**.
 - To delete one custom avoidance, select the avoidance and select **Delete**.

Fuel tracking

You can set your device to estimate your fuel usage, warn you when you approach the maximum estimated fuel distance, and suggest fuel stops based on your estimated fuel range. When fuel tracking is enabled,  indicates the current fuel status.

White: fuel tracking is disabled, or the device is not connected to the motorcycle mount.

Green: the estimated fuel range is above the fuel tank warning level.

Yellow: the estimated fuel range is below the fuel tank warning level.

Red: the estimated distance remaining on the tank is 0.

Enabling fuel tracking

Before you can enable fuel tracking, the device must be placed in the motorcycle mount.

When you enable fuel tracking, a fuel gauge appears on the trip computer ([Viewing Trip Data, page 26](#)).

- 1 Fill your fuel tank.
- 2 Select  > **Fuel Settings** > **Fuel Tracking**.
- 3 Select **Distance Per Tank**.
- 4 Enter the distance the vehicle travels on a tank of fuel and select **Done**.

Setting a low-fuel warning

You can set the device to warn you when the tank is low on fuel.

the device must be connected to the motorcycle mount to give low-fuel warnings.

- 1 Enable fuel tracking ([Enabling fuel tracking, page 24](#)).
- 2 Select **Remaining Fuel Warning**.
- 3 Enter a distance and select **Done**.

When you have only enough fuel left to travel the distance you entered, a low-fuel warning appears on the map page.

Resetting the Fuel Tank Mileage

When you refill your fuel tank, you should reset the fuel tank mileage on your device to more accurately track your remaining fuel.

Select  > **Fuel Settings** > **Reset Fuel Tank**.

Enabling dynamic fuel stops







Before you can enable dynamic fuel stops, the device must be in motorcycle mode, placed in the motorcycle mount and fuel tracking must be enabled.

You can set the device to suggest fuel stops based on your estimated fuel range.

Select  > **Fuel Settings** > **Dynamic Fuel Stops**.

Using the Map

You can use the map to navigate a route ([Your route on the map, page 20](#)) or to view a map of your surroundings when no route is active.

- 1 Select **View Map**.
- 2 Select anywhere on the map.
- 3 Select an option:
 - Drag the map to pan left, right, up, or down.
 - To add or remove map layers, select .
 - To zoom in or out, select  or .
 - To switch between North Up, 2D and 3D views, select .
 - To plan a route, drag the map to reveal the  icon and select  ([Planning a Route, page 20](#)).
 - To start a route, select a location on the map and select **Go!** ([Starting a Route to a Point on the Map, page 19](#)).

Map tools

Map tools provide quick access to information and device functions while you view the map. When you activate a map tool, it appears in a panel at the edge of the map.

Stop: stops navigation of the active route.

Edit Route: allows you to re-route or skip locations in your route ([Changing Your Active Route, page 22](#)).

Mute Navigation: mutes the device audio.

Towns Ahead: displays upcoming towns and services along your active route or along a motorway.

Up Ahead: displays upcoming locations along the route, or the road on which you are travelling ([Up ahead, page 25](#)).

Elevation: displays upcoming elevation changes.

Traffic: displays traffic conditions along your route or in your area. This feature is not available in all areas or for all device models.

Trip Data: displays customisable trip data, such as speed or mileage ([Viewing trip data from the map, page 26](#)).

Track Recorder: displays the track data for your active track.

Turns: displays a list of upcoming turns in your route ([Viewing turns and directions, page 21](#)).

Phone: displays a list of recent phone calls from your connected phone and displays in-call options while a phone call is active.

Weather: displays weather conditions for your area ([Viewing the Weather Forecast, page 52](#)).

Music Player: displays media controls and media information.

Smart Notifications: displays recent smart notifications from your connected phone.

Group Ride: displays the distance and direction of the members in your group ride ([Group Ride, page 47](#)).

Free Ride: displays the compass.

Garmin Messenger: displays your Garmin Messenger messages.

Lean Angles: displays the current lean angle of your motorcycle ([Lean Angles, page 43](#)).

zūmo™ R1 Radar: displays information from your connected motorcycle radar device.

Radio: allows you to use the push-to-talk feature with a compatible Bluetooth® headset ([Enabling Push-to-Talk with a Headset, page 46](#)).

Viewing a map tool

- 1 From the map, select .
- 2 Select a map tool to open it.

TIP: with some map tools, you can touch the map tools to expand it or show more detailed information.
- 3 When you are done using the map tool, select .

Up ahead

The Up Ahead tool provides information about upcoming locations along your route or the road on which you are travelling. You can view upcoming points of interest by category, such as restaurants, fuel stations or roadside services.

You can customise the categories that show in the Up Ahead tool.

Viewing upcoming locations

- 1 From the map, select  > **Up Ahead**.

While you are travelling, the map tool shows the next location along your road or route.

- 2 Select an option:

- If the map tool shows categories, select a category to view a list of nearby locations in that category.
- If the map tool shows upcoming locations, select a location to view location details or start a route to the location.

Customising the up ahead categories

You can change the location categories that appear in the Up Ahead tool.

- 1 From the map, select  > **Up Ahead**.

- 2 Select a category.

- 3 Select .

- 4 Select an option:

- To move a category up or down in the list, select and drag the arrow next to the category name.
- To change a category, select the category.
- To create a custom category, select a category, select **Custom Search** and enter the name of a business or category.

- 5 Select **Save**.

Towns Ahead

While you are travelling on a highway or navigating a route that includes a highway, the Towns Ahead tool provides information about upcoming towns along the highway. For each town, the map tool shows the distance to the highway exit and the services available, similar to the information on highway road signs.

Viewing Upcoming Towns and Exit Services

- 1 From the map, select  > **Towns Ahead**.

While you are travelling along a motorway or an active route, the map tool shows information about upcoming towns and exits.

- 2 Select a town.

The device shows a list of points of interest located at the selected town exit, such as fuel stations, lodging or restaurants.

- 3 Select a location, and select **Go!** to start navigating.

Trip information

Viewing trip data from the map

From the map, select  > **Trip Data**.

Customising the trip data fields

- 1 From the map, select  > **Trip Data**.

- 2 Select a trip data field.

- 3 Select an option.

The new trip data field appears in the trip data map tool.

Viewing Trip Data

The trip data tool displays your speed and provides statistics about your trip.

From the map, select **Speed**.

Resetting trip information

- 1 From the map, select **Speed**.

- 2 Select  > **Reset Field(s)**.

- 3 Select an option:

- When not navigating a route, select **Select All** to reset every data field on the first page except the speedometer.
- Select **Reset Overall Data** to reset the information on the trip computer.

- Select **Reset Max. Speed** to reset the maximum speed.
- Select **Reset Trip B** to reset the odometer.

Viewing Traffic Information

Before you can view up-to-date traffic information, you must pair and connect your device to the Tread® app on your phone (*Pairing with Your Smartphone, page 37*).

NOTICE

Garmin® is not responsible for the accuracy or timeliness of the traffic information.

- 1 From the map, select  > **Traffic**.
- 2 Touch the **Traffic** panel to view the traffic incidents on the map.

Customising the map

Customising the map layers

- 1 From the map, select  > **Layers**.
- 2 Under **Map Type**, select a map type.

With some map types, you can select  > **Hybrid Map** to combine two map types.

the Satellite Imagery map only shows satellite images for areas where you have downloaded satellite imagery (*Downloading Outdoor Maps+ Content, page 27*).
- 3 Under **Map Details**, select the types of information to display over the map.

NOTE: some layers are incompatible with each other and cannot be enabled at the same time. Enabling a layer automatically disables any incompatible layers.

NOTE: some map layers require an Outdoor Maps+ subscription.

Viewing Popular Motorcycle Paths on the Map

You can enable the device to highlight popular motorcycle paths on the map. This can help you choose roads that provide a more enjoyable ride.

From the map, select  > **Popular Paths (Moto)**.



Downloading Outdoor Maps+ Content

Before you can download Outdoor Maps+ content, you must purchase an Outdoor Maps+ subscription. Go to garmin.com/outdoormaps for more information.

You must connect your device to Wi-Fi® before you can download Outdoor Maps+ content (*Connecting to a Wi-Fi® Network, page 59*).

To see Outdoor Maps+ content on the map, you must download the content for a specific area.

NOTE: some Outdoor Maps+ layers are available only in certain areas.

- 1 Select  > **Map** > **Map Manager** > **Outdoor Maps+** > **Download Maps**.
- 2 Select .
- 3 Select each map layer you want to download.

TIP: you can touch  to see information about each map layer.

The selected map layers are marked with a tick mark.
- 4 Select .
- 5 Drag the map and pinch to zoom in and out on the map until the highlighted rectangle covers the area for which you want to download map data.

TIP: as you change the size of the area, the total download size and your current disk usage appear at the top of the screen.
- 6 Select  to start downloading.

You can continue using your device while it downloads Outdoor Maps+ content.

Viewing Your Collections on the Map

Before you can view the Collections map layer, you must pair your device with the Tread® app to sync your device with your Garmin® account.

You can view the items from your Garmin account directly on the map.

NOTE: items from your Garmin account that were not added to any collection appear in the Unorganised collection on your zūmo® device.





- 1 From the map, select  > **Collections**.
- 2 Select one or more collection categories from the list.
The tracks and waypoints from the selected collections appear as icons on the map.

Changing the map data field

- 1 From the map, select a data field.
NOTE: you cannot customise Speed.
- 2 Select a type of data to display.

Changing the Map Shortcuts

You can change the shortcut buttons that appear on the edge of the map.

- 1 From the map, select  > .
- 2 Select an option:
 - To remove a shortcut button, select .
 - To replace a shortcut button, select  and select a shortcut button to display.
- 3 Select **Save**.

Changing the map perspective

- 1 Select  > **Map** > **Driving Map View**.
- 2 Select an option:
 - Select **Track Up** to display the map in two dimensions (2-D), with your direction of travel at the top.
 - Select **North Up** to display the map in 2-D with North at the top.
 - Select **3-D** to display the map in three dimensions.
 - Select **Auto Zoom to Group** to automatically adjust the zoom level so all riders in a group ride are visible on the map.
- 3 Select **Save**.

Changing the Map Region

When the device is connected to a Wi-Fi® network, you can download new map regions directly onto the device.

- 1 Select  > **Map Manager** > **Manage Device Maps**.
- 2 Select an option:
 - To remove a map region, select the region and select **Remove**.
 - To install a new map region to the device's internal memory, select the region and select **Install to Device**.
 - To install a new map region to a memory card (*Installing a memory card for maps and data, page 56*), select the region and select **Install to the Memory Card**.

As you add or remove new regions, a bar at the top of the page displays the available storage space on the device.

- 3 After you have finished adding and removing map regions, select **Apply**.

Finding and saving locations

The maps loaded in your device contain locations, such as restaurants, hotels, vehicle services and detailed street information. The Where To? menu helps you find your destination by providing several methods to browse, search and save this information.

From the main menu, select **Where To?**.

- To quickly search all locations on your device, select **Q Search** (*Finding a location using the search bar, page 29*).
- To find an address, select **Address** (*Finding an address, page 31*).
- To browse or search pre-loaded points of interest by category, select **Categories** (*Finding a location by category, page 29*).
- To search near a different town or area, select the current search area, then select a new search area (*Changing the search area, page 30*).
- To view and edit your saved locations, select **Waypoints** (*Saving Locations, page 33*).
- To view locations you have recently selected from the search results, select **History** (*Viewing history, page 33*).
- To search for motorhome parks and campsites, select **Ultimate Public Campgrounds** (*Finding Ultimate Campgrounds points of interest, page 32*).
- To search for locations that are part of your Outdoor Maps+ subscription, select **Outdoor Maps+**.
- To browse and search Tripadvisor® traveller ratings, select **Tripadvisor** (*Finding Tripadvisor® points of interest, page 32*).
- To find national parks and explore park maps, select **National Parks** (*Finding National Parks, page 32*).
- To navigate to specific geographic coordinates, select **Coordinates** (*Finding a location using coordinates, page 31*).

Points of Interest

NOTICE

You are responsible for understanding and complying with any applicable rules, laws or regulations associated with points of interest.

A point of interest is a place that you may find useful or interesting. Points of interest are organised by category and can include popular travel destinations such as petrol stations, restaurants, hotels, and entertainment venues.

Finding a location using the search bar

You can use the search bar to search for locations by entering a category, brand name, address or town name.

- 1 Select **Where To?**.
- 2 Select **Search** in the search bar.
- 3 Enter all or part of the search term.
Suggested search terms appear below the search bar.
- 4 Select an option:
 - To search for a type of business, enter a category name (for example, "cinemas").
 - To search for a business name, enter all or part of the name.
 - To search for an address near you, enter the house number and street name.
 - To search for an address in another town, enter the house number, street name, town and county.
 - To search for a town, enter the town and county.
 - To search for coordinates, enter latitude and longitude coordinates.
- 5 Select an option:
 - To search using a suggested search term, select the term.
 - To search using the text you entered, select **Q**.
- 6 If necessary, select a location.

Finding a location by category

- 1 Select **Where To?**.
- 2 Select a category or select **Categories**.
- 3 If necessary, select a subcategory.

- 4 Select a location.

Navigating to points of interest within a venue

NOTE: this feature is not available for all locations.

You can create a route to a point within a larger venue, such as a specific store in a shopping mall, a terminal at an airport or nearby parking areas.

- 1 Select **Where To?** > **Search**.
- 2 Enter the name of the venue and select **Q**.
- 3 Select the venue.
A list of categories for points of interest within the venue appears.
- 4 Select a category, select a location and select **Go!**.

The device creates a route to the parking area or venue entrance closest to the selected point.

Location Search Results

The location search results appear in a list, with the nearest location at the top. Each numbered location also appears on the map. You can scroll down to view more results.

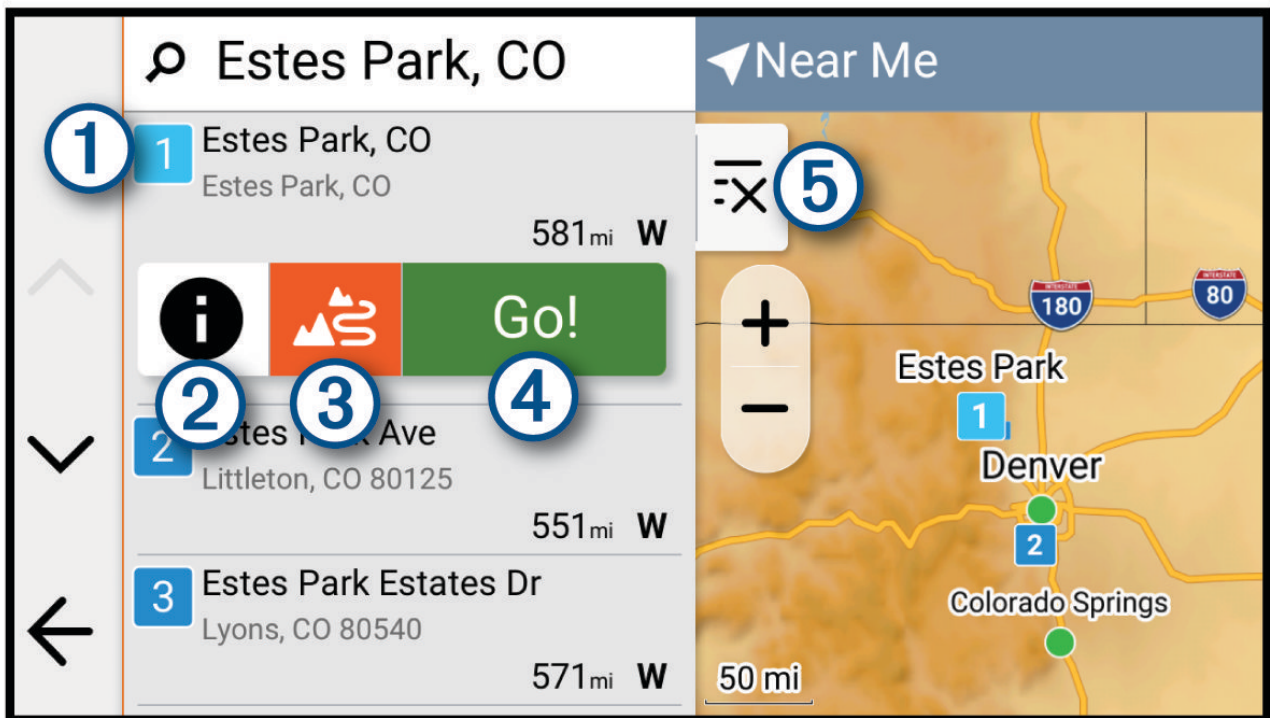

①	Select a location to view the option menu.
② ⓘ	Select to view detailed information about the location.
③ 🏔️	Select to start navigating using adventurous routing (<i>Taking a Route Using Garmin Adventurous Routing™</i> , page 19).
④ Go!	Select to start navigating to the location using the default route calculation mode for the current vehicle profile.
⑤ 🗺️	Select to view the search results on the map in full screen.

Changing the search area

By default, the device searches for locations near your current location. You can also search other areas, such as near your destination, near another city, or along your active route.

- 1 Select **Where To?**.
- 2 Select the current search area ①.

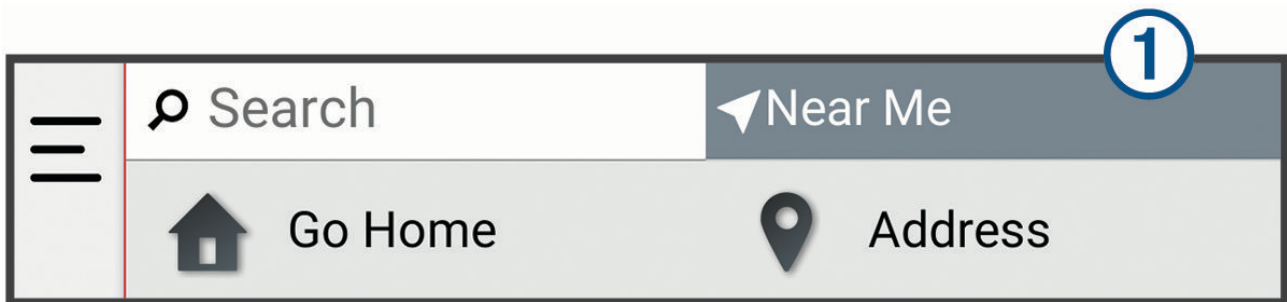

3 Select a search area.

4 If necessary, follow the on-screen instructions to select a specific location.

The selected search area appears at the top of the screen. When you search for a location using any of the options in the Where To? menu, the device suggests locations near this area first.

Parking

Finding Parking Near Your Current Location

1 Select **Where To? > Categories > Parking**.

2 Select a parking location.

3 Select **Go!**.

Finding Parking Near a Specified Location

1 Select **Where To?**.

2 Search for a location.

3 From the location search results, select a location.

4 Select **i > Parking**.

A list of parking areas near the selected location appears.

5 Select a parking location.

6 Select **Go!**.

Search tools

Search tools allow you to search for specific types of locations by responding to on-screen prompts.

Finding an address

NOTE: the order of the steps may change depending on the map data loaded on your device.

1 Select **Where To?**.

2 If necessary, select the current search area to search near a different city or area.

3 Select **Address**.

4 Follow the on-screen instructions to enter address information.

5 Select the address.

Finding a junction

You can search for a junction between two streets, motorways, or other roads.

1 Select **Where To? > Junctions**.

2 Follow the on-screen instructions to enter street information.

3 Select the junction.

Finding a location using coordinates

You can find a location using latitude and longitude coordinates.

1 Select **Where To? > Coordinates**.

2 If necessary, select , and change the coordinate format or datum.

3 Select **Coordinates**.

4 Enter the latitude and longitude coordinates, and select **Done**.

5 Select an option:

- To save the coordinates as a location, select **Save**.
- To start a route to the coordinates, select **Go!**.

Finding National Parks

Device models that include maps for North America or the United States also include detailed information for national parks in the United States. You can navigate to a national park or to a location within a national park.

NOTICE

You are responsible for understanding and complying with any applicable rules, laws or regulations associated with national parks.

1 Select **Where To? > National Parks**.

A list of national parks appears, with the nearest park at the top.

2 Select **Search**, and enter all or part of the park name to narrow the results (optional).

3 Select a national park.

A list of categories for locations of features and amenities within the park appears below the park name.

4 Select an option:

- To start navigating to the park, select **Go!**.
- To view more park information or explore the park features and amenities, select **i**.
- To quickly find a location within the park, select a category from the list below the park name and select a location.

Finding Ultimate Campgrounds points of interest

NOTE: this feature is not available in all areas.

NOTICE

You are responsible for understanding and complying with any applicable rules, laws or regulations associated with campsites and points of interest.

Your device includes Ultimate Campgrounds points of interest, which allow you to find public campsites near your location.

1 Select **Where To? > Ultimate Public Campgrounds**.

2 If necessary, select **Search Filters**, select one or more search filters and select **Search**.

3 Select a location.

Tripadvisor®

NOTICE

Garmin® is not responsible for the accuracy or timeliness of the Tripadvisor information.

You are responsible for understanding and complying with any applicable rules, laws or regulations associated with points of interest.

Your device includes Tripadvisor traveller ratings. Tripadvisor ratings appear automatically in the search results list for restaurants, hotels and attractions. You can also search for nearby Tripadvisor points of interest and sort by distance or popularity.

Finding Tripadvisor® points of interest

1 Select **Where To? > Tripadvisor**.

2 Select a category.

3 If necessary, select a subcategory.

A list of nearby Tripadvisor points of interest for the category appears.

4 Select **Sort Results** to filter the displayed points of interest by distance or popularity (optional).

5 Select **Q**, and enter a search term (optional).

Trendy Places

NOTICE

Garmin® is not responsible for the accuracy or timeliness of the Tripadvisor® information. You are responsible for understanding and complying with any applicable rules, laws or regulations associated with points of interest.

The Trendy Places search feature includes Tripadvisor points of interest and ratings, providing a comprehensive list of attractions. You can filter the search results by categories, ratings and distance from the route.

NOTE: Tripadvisor points of interest are not available in all areas.

Viewing history

Your device stores a history of the last 50 locations you have found.

Select **Where To?** > **History**.

Clearing the list of recently found places

Select **Where To?** > **History** >  > **Clear** > **Yes**.

Viewing current location information

You can use the Where Am I? page to view information about your current location. This feature is helpful if you need to tell emergency personnel your location.

From the map, select the vehicle.

Finding emergency services and fuel

You can use the Where Am I? page to find the nearest hospitals, police stations, and fuel stations.

1 From the map, select the vehicle.

2 Select **Hospitals**, **Police Station**, or **Petrol Stations**.

NOTE: some service categories are not available in all areas.

A list of locations for the selected service appears, with the nearest locations at the top.

3 Select a location.

4 Select an option:

- To navigate to the location, select **Go!**.
- To view the phone number and other location details, select .

Getting directions to your current location

If you need to tell another person how to get to your current location, your device can give you a list of directions.

1 From the map, select the vehicle.

2 Select  > **Directions to Me**.

3 Select a starting location.

4 Select **Select**.

Adding a shortcut

You can add shortcuts to the Where To? menu. A shortcut can point to a location, a category, or a search tool. The Where To? menu can contain up to 36 shortcut icons.

1 Select **Where To?** > **Personalise**.

2 Select an item.

Removing a shortcut

1 Select **Where To?** >  > **Remove Shortcut(s)**.

2 Select a shortcut to remove.

3 Select the shortcut again to confirm.

4 Select **Done**.

Saving Locations

Saving a location

1 Search for a location (*Finding and saving locations, page 29*).

2 Select a location from the list of search results.

3 Select  > **Save**.

4 If necessary, select **Name** to edit the name of the location.

5 Select **Save**.

Saving your current location



- 1 From the map, select the vehicle icon.
- 2 Select **Save**.
- 3 If necessary, select **Name** to edit the name of the location.
- 4 Select **Save**.

Editing a saved location

- 1 Select **Where To? > Waypoints**.
- 2 If necessary, select a category.
- 3 Select a location.
- 4 Select **Edit**.
- 5 Select an option:
 - Select **Name**.
 - Select **Map Symbol** to change the symbol used to mark the saved location on a map.
 - Select **Collections** to add or remove the location from your saved collection categories.
 - Select **Coordinates** to edit the GPS coordinates for the location.
- 6 Edit the information.
- 7 Select **Done**.

Viewing Your Saved Items

You can use the Favourites app to view your saved items, such as waypoints, routes and tracks. When paired with the Tread® app, your saved items periodically sync with your Garmin® account.

- 1 Select  > **Favourites**.
- 2 If necessary, select the category filter  to browse different collections and filter by item type.

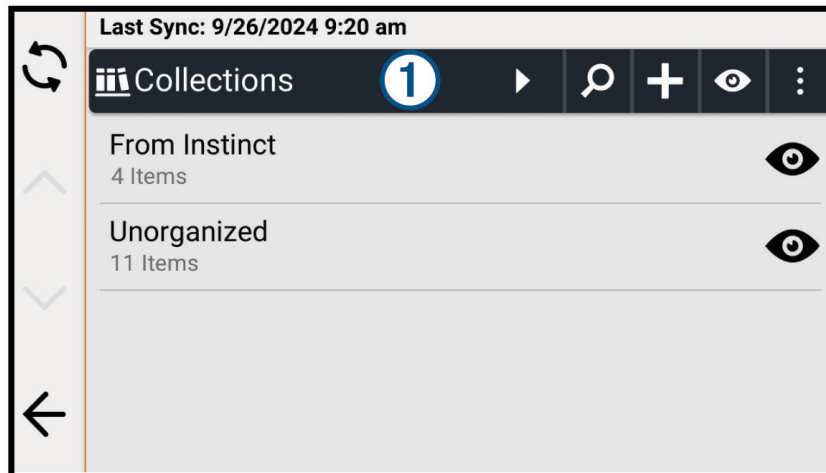



Sharing a Saved Item

You can share items using a connected smartphone with the Tread® app or you can save them to a memory card.

- 1 From the **Favourites** app, select the item you want to share.
- 2 Select an option:
 - To share a route or track, select  > **Share**.
 - To share a waypoint, select **Share**.
- 3 Select an option:
 - To send the item to the Tread app on your phone, select **Garmin Tread**.
 - To save the item to a memory card, select **Memory Card**.
- 4 If necessary, edit the name for the .gpx file.

Sharing Multiple Saved Items

You can share multiple items in a single .gpx file.

- 1 From the **Favourites** app, select a category or collection filter including all the items you want to share.
- 2 Select  > **Share**.
- 3 Select the items to share.
- 4 Select .
- 5 Select an option:
 - To send the items to the Tread® app on your phone, select **Garmin Tread**.
 - To save the items to a memory card, select **Memory Card**.
- 6 If necessary, edit the name for the .gpx file.

Synchronising Garmin® Account Data

Before you can synchronise account data, you must pair your device with the Tread® app ([Pairing with Your Smartphone, page 37](#)).

You can synchronise data, such as tracks, with your Garmin account. Your device periodically synchronises data with your account automatically. You can also synchronise data manually at any time.

- 1 Select  > **Favourites**.
- 2 Select .

Vehicle Profiles

WARNING



Entering your vehicle profile characteristics does not guarantee that your vehicle's characteristics will be accounted for in all route suggestions or that you will receive the warning icons in all cases. Limitations may exist in the map data such that your device cannot account for these restrictions or road conditions in all cases. Always defer to all posted road signs and road conditions when making driving decisions.

By using different vehicle profiles, you can quickly change several device settings, such as which map layers are enabled and which route calculation mode is used by default.

Routing and navigation are calculated differently based on your vehicle profile. The device avoids including restricted or impassable areas in routes based on the dimensions, weight and other characteristics you entered for your vehicle.

The current active vehicle profile is indicated by an icon in the status bar. The navigation and map settings on your device can be customised separately for each vehicle type.

Switching the Vehicle Profile

- 1 From the status bar, select the vehicle profile icon, such as  or .
- 2 Select a vehicle profile.
The vehicle profile information appears, including measurements and weight.
- 3 Select **Select**.







Adding a vehicle profile

You can add a vehicle profile for each vehicle to be used with your device.

- 1 Touch the current vehicle profile icon in the status bar.
- 2 Select .
- 3 Select your current vehicle type.
- 4 Enter the vehicle characteristics such as size and traction method.
- 5 Select the default route calculation method.

Editing a vehicle profile

You can change basic vehicle profile information or add detailed information to a vehicle profile, such as maximum speed.

- 1 Select  > **Vehicle Profile**.
- 2 Select a vehicle profile to edit.
- 3 Select an option:
 - To edit the vehicle profile information, select  and select a field to edit.
 - To rename the vehicle profile, select  >  > **Rename Profile**.
 - To delete the vehicle profile, select  >  > **Delete**.

Live services, traffic and smartphone features

WARNING

Do not read or interact with notifications while driving, because doing so can cause distraction that could lead to an accident resulting in serious personal injury or death.

NOTICE

Garmin® is not responsible for the accuracy or timeliness of the traffic information.

The Tread® app allows your device to receive smart notifications and live information, such as live traffic data and weather information.

Live traffic data: sends live traffic data to your device, such as traffic incidents and delays, construction zones and road closings.

Weather information: sends real-time weather forecasts, road conditions and weather radar to your device ([Viewing the Weather Forecast, page 52](#)).

Smart Notifications: displays phone notifications and messages on your device. This feature is not available for all languages.

Hands-Free calling: allows you to place and receive phone calls through the device using your connected Bluetooth® headset.

Send locations to device: allows you to send locations from your smartphone to your navigation device.

Pairing with Your Smartphone

You can pair your zūmo® navigator with your smartphone and the Tread® app to enable additional features and access live information ([Live services, traffic and smartphone features, page 37](#)).

- 1 Turn on your zūmo navigator, and place the navigator and your smartphone within 3 m (10 ft.) of each other.
- 2 From your zūmo navigator, select  > **Phone** > **Add a Phone**.
- 3 Using your phone, scan the QR code to download and install the Tread app.
TIP: you can use the camera app on most phones to scan the QR code.
- 4 Follow the on-screen instructions to sign in to a Garmin® account and complete the pairing and setup process.

The main app dashboard appears. After the devices are paired, you can enable or disable smartphone features on your navigator ([Phone settings, page 53](#)). The devices connect automatically when they are turned on and within range.

Pairing a wireless headset

NOTE: when your zūmo® device is paired to the Tread® app on your phone, you can pair your headset directly to your phone using Bluetooth® technology instead of your zūmo device. Only one headset can receive navigation prompts and phone calls at a time. Up to two headsets can be used for multimedia audio.

- 1 Place your headset and your navigation device within 10 m (33 ft.) of each other.
- 2 On your navigation device, select  > **Headphone** > **Add Headset**.
- 3 On your headset, enable Bluetooth technology and make it visible to other Bluetooth devices.
- 4 Follow the on-screen instructions on your navigation device to complete the pairing process.

After the pairing process is complete, you can enable or disable features for your paired wireless headset ([Headset Settings, page 53](#)).

Smart Notifications

While your device is connected to the Tread® app, you can view notifications from your smartphone on your zūmo® device, such as text messages, incoming calls and calendar appointments.

Receiving notifications

WARNING

Do not read or interact with notifications while driving, because doing so can cause distraction that could lead to an accident resulting in serious personal injury or death.

Before you can use this feature, your device must be connected to a supported phone running the Tread® app ([Pairing with Your Smartphone, page 37](#)).

From most pages, a pop-up appears when the device receives a notification from your smartphone. If the device is moving, you must verify you are a passenger and not the driver before you can view notifications.

NOTE: if you are viewing the map, notifications appear in a map tool.

- To ignore a notification, select **OK**.
The pop-up closes, but the notification remains active on your phone.
- To view a notification, select **View**.
- To listen to the notification, select **View > ►**.
The device reads the notification using text-to-speech technology. This feature is not available for all languages.
- To perform additional actions, such as dismissing the notification from your phone, select **View**, and select an option.

NOTE: additional actions are available for only some notification types and must be supported by the app generating the notification.

Receiving notifications while viewing the map

WARNING

Do not read or interact with notifications while driving, because doing so can cause distraction that could lead to an accident resulting in serious personal injury or death.

Before you can use this feature, your device must be connected to a supported phone running the Tread® app (*Pairing with Your Smartphone*, page 37).

When you are viewing the map, new notifications appear in a map tool at the edge of the screen. If the device is moving, you must verify you are a passenger and not the driver before you can view notifications.

- To ignore a notification, select **X** or wait for the pop-up to expire.
The pop-up closes, but the notification remains active on your phone.
- To view a notification, select the notification text.
- To listen to the notification, select **Play Message**.
The device reads the notification using text-to-speech technology. This feature is not available for all languages.

Viewing the list of notifications

You can view a list of all active notifications.

1 Select > **Smart Notifications**.

The list of notifications appears. Unread notifications appear black, and previously read notifications appear grey.

2 Select an option:

- To view a notification, select the notification description.
- To listen to a notification, select **►**.
The device reads the notification using text-to-speech technology. This feature is not available for all languages.

Hands-free calling

NOTE: while most phones and headsets are supported and can be used, a particular phone or headset cannot be guaranteed to be compatible. All features may not be available for your phone.

Using Bluetooth® technology, your device can connect to your compatible mobile phone and wireless headset or helmet to become a hands-free device. To check compatibility, go to www.garmin.com/bluetooth.

Placing a call

1 Select > **Phone**.

2 Select an option:

- To dial a number, select **Dial**, enter the phone number and select **Dial**.
- To view numbers of recent, missed or recently dialed or received calls, select **Recents**, select a log, select a number and select **Call** to dial it.
- To call a contact from your phone book, select **Contacts**, select a contact and select **Call**.
- To call a point of interest location such as a restaurant or attraction, select **Browse Categories**, select a category, select a location and select **Call**.

Calling home

Select  > **Phone > Call Home**.

When using this feature for the first time, you are prompted to dial the home phone number.

TIP: you can reset the home phone number by selecting  > **Set Home Number**.

Using in-call options

In-call options are available when you answer a call. Some options may not be compatible with your phone.

TIP: if you close the in-call options page, you can open it again by selecting  from any screen. You can also select the caller from the map.

- To set up a conference call, select **Add Call**.

- To transfer audio to your phone, select **Call in Progress on Navigator**.

TIP: you can use this feature if you want to disconnect the Bluetooth® connection and remain on the call, or if you need privacy.

- To use the dial pad, select **Keypad**.



TIP: you can use this feature to use automated systems, such as voice mail.

- To mute the microphone, select **Mute**.
- To hang up, select **End Call**.

Disconnecting a Bluetooth® device

You can temporarily disconnect a Bluetooth device without deleting it from the paired devices list. The Bluetooth device can connect to your zūmo® navigator automatically in the future.

1 Select an option:

- To disconnect a phone, select  > **Phone**.
- To disconnect a headset, select  > **Headphone**.

2 Select the device to disconnect.

3 Select **Disconnect**.

Deleting a paired phone

You can delete a paired phone to prevent it from automatically connecting to your device in the future.

1 Select  > **Phone**.

2 Select the phone and select **Forget Device**.

Using the apps

Garmin Performance App

⚠ WARNING

Use of this device in a track session, drag race session or any other kind of racing session is intended only for recreational use on a racetrack. Never use this device on public roads. Failure to follow this warning may result in an accident causing property damage, serious personal injury or death. You are responsible for using this device in a safe and prudent manner.

Do not review any track sessions or drag race sessions while riding. Failure to pay attention to your surroundings and road conditions can result in serious personal injury or death.

NOTE: before you can use the Garmin Performance app on your device, you must have a Garmin Performance Package™ subscription (*Subscribing to a Garmin Performance Package™*, page 40).

The Garmin Performance app allows you to start a track session or drag race session from your zūmo® device and view performance data from your sessions, such as lap times and race summaries. You can also view current weather conditions before a race and past weather conditions for every session.

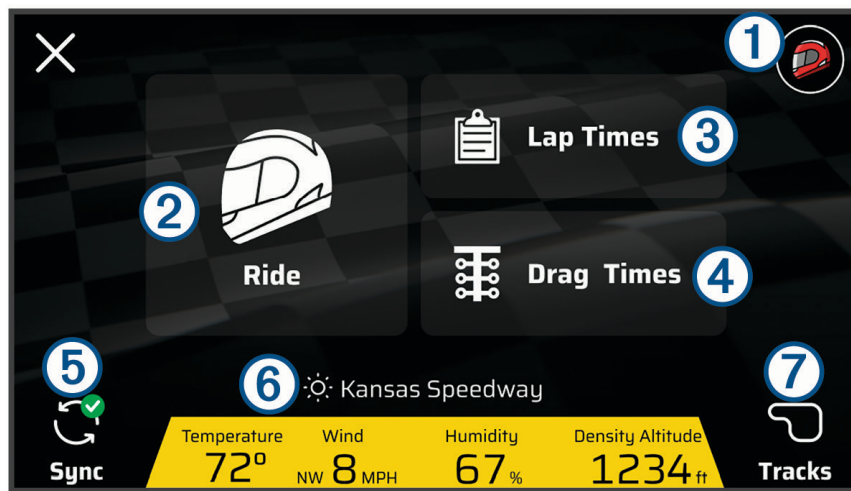

①	Select to view your race profile
② Ride	Select to start a track or drag race session
③ Lap Times	Select to view a summary of previous track sessions
④ Drag Times	Select to view a summary of previous drag race sessions
⑤ Sync	Select to sync your ride sessions
⑥	Displays environmental conditions
⑦ Tracks	Select to view the track database

Subscribing to a Garmin Performance Package™

You can purchase a Garmin Performance Package subscription to access racing features on your zūmo® device.

- 1 From the home screen, select  > **Garmin Performance**.
- 2 Scan the QR code and follow the on-screen instructions to complete the subscription process.







Garmin Catalyst™ App

The Garmin Catalyst app allows you to view race performance data from your zūmo® device, such as lap times, drag times and session summaries. You can also view weather conditions for every session. The app provides customisable icons for your rider and vehicle profiles. You can download the Garmin Catalyst app from the app store on your mobile device.

NOTE: the icons for your driver profiles do not synchronise with your zūmo device.

Starting a Track Session

Before you can start a track session, your device must acquire satellite signals. You can select  in the status bar to check the current signal strength and accuracy.

- 1 From the **Garmin Performance** app, select **Ride > Track**.
- 2 Select a track.
- 3 If necessary, select a track configuration.
- 4 Select an option:
 - To change your driver profile, select  and select a different profile.
 - To change your vehicle profile, select  and select a different profile.
 - To configure lap timer settings, select  and select **Delta Timer** or **Lap Timer Display**.
 - To change your track conditions, select ,  or .
 - To calibrate lean angles, select  and follow the on-screen instructions.
- 5 Select **Start**.
- 6 Start riding.

The timer starts automatically when you cross the start line.

Track Session Timer

As you ride, the device keeps track of your progress. The session timer keeps track of your lap number and shows your best lap times.

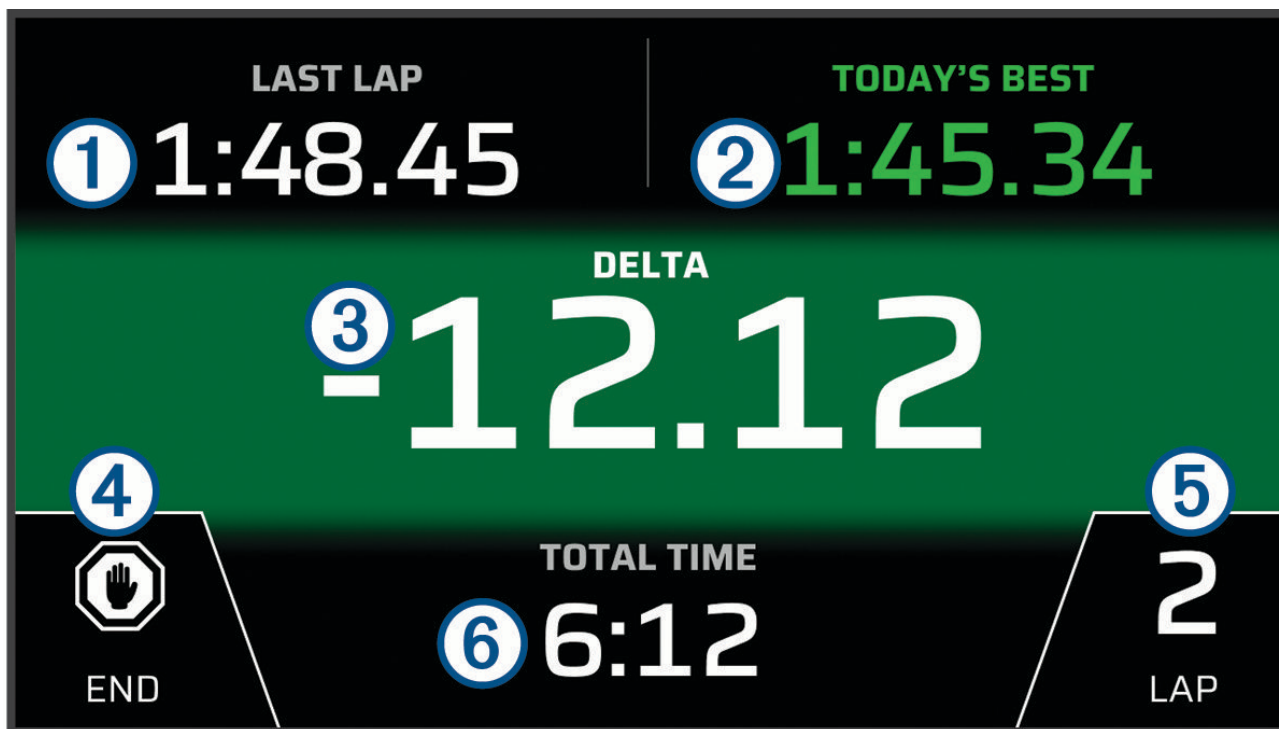

① Last Lap	Displays the last lap time during the current session.
② Best Lap	Displays the best lap time for the current session. This timer is customisable when starting a ride (Starting a Track Session, page 41).
③ DELTA	Displays the time difference between the current lap and the best lap during the current session.
④ END	Select to pause the timer or end the current session.
⑤ Lap	Displays the current lap number.
⑥ Total Time	Displays the total lap time.





Adding a Track in the Garmin Performance App

You can add a track that is not already loaded on your device. The device uses your GPS location and your vehicle's movements to create a map of the track.

- 1 From the **Garmin Performance** app, select **Ride > Track > Add a Track**.
- 2 Enter a track name.
- 3 If necessary, adjust your rider profile and session settings (*Starting a Track Session, page 41*).
- 4 Select **Start**.
- 5 Start driving.
After you exit the pit area and enter the track, you must drive in a straight line for at least 0.5 seconds at a minimum of 90 km/h (55 mph) and complete one full lap.
- 6 Select **END** after you have completed the drive session.
- 7 Select **▶▶** or **◀◀** to position the starting line on the map.
- 8 Select **Save**.

Starting a Drag Race Session

Before you can start a drag race session, your device must acquire satellite signals. You can select  in the status bar to check the current signal strength and accuracy.

- 1 From the **Garmin Performance** app, select **Ride > Drag Race**.
- 2 Select an option:
 - To change the distance or speed of your drag race session, select .
 - To change your vehicle profile, select  and select a different profile.
 - To change your track conditions, select .
 - To add front and rear tyre pressure values, select .
 - To add a launch control RPM value, select .
- 3 Select **Start**.
- 4 Start racing.
The timer starts automatically.

Drag Race Session Timer

During your drag race session, the device keeps track of your speed and progress. The session timer keeps track of your total time and shows your time splits.

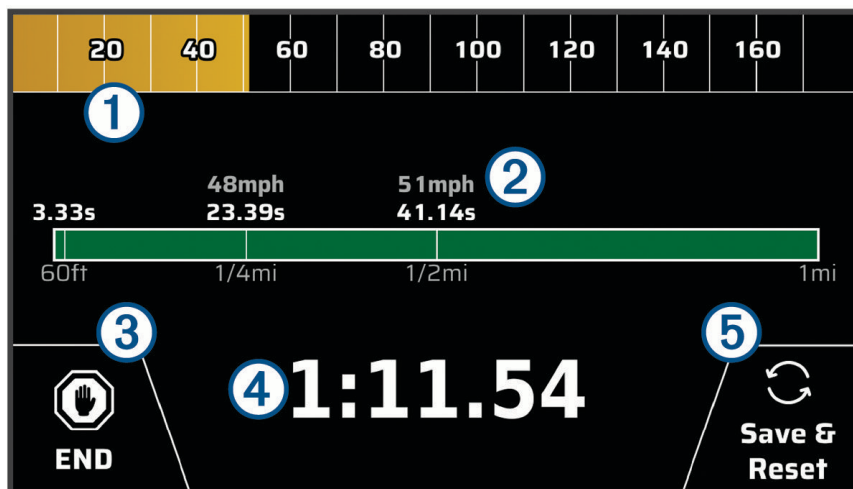

①	Displays your riding speed during your session. When stopped, displays your maximum speed during the session.
②	Displays the time splits for the current session.
③ END	Select to end the current session.
④	Displays the total time of the current session.
⑤ Save & Reset	Select to save the current session and reset the session timer.

Lean Angles



⚠ WARNING

The Lean Angle application is intended to show motorcycle angles based on calibrated measurements only. You are responsible for calibrating the device. Changes to the position of the device after calibration may affect the accuracy of its measurements. Measured values are suggestions only based on your input into the device. Take readings often and carefully, and allow the readings to stabilise after significant changes in environmental conditions. Always allow a margin of safety for changing conditions and reading errors. Failure to account for your vehicle and your environment could cause an incident resulting in death or serious injury.

The device displays the current lean angle of your motorcycle. Select , and follow the on-screen instructions to calibrate the device every time the mounting changes.

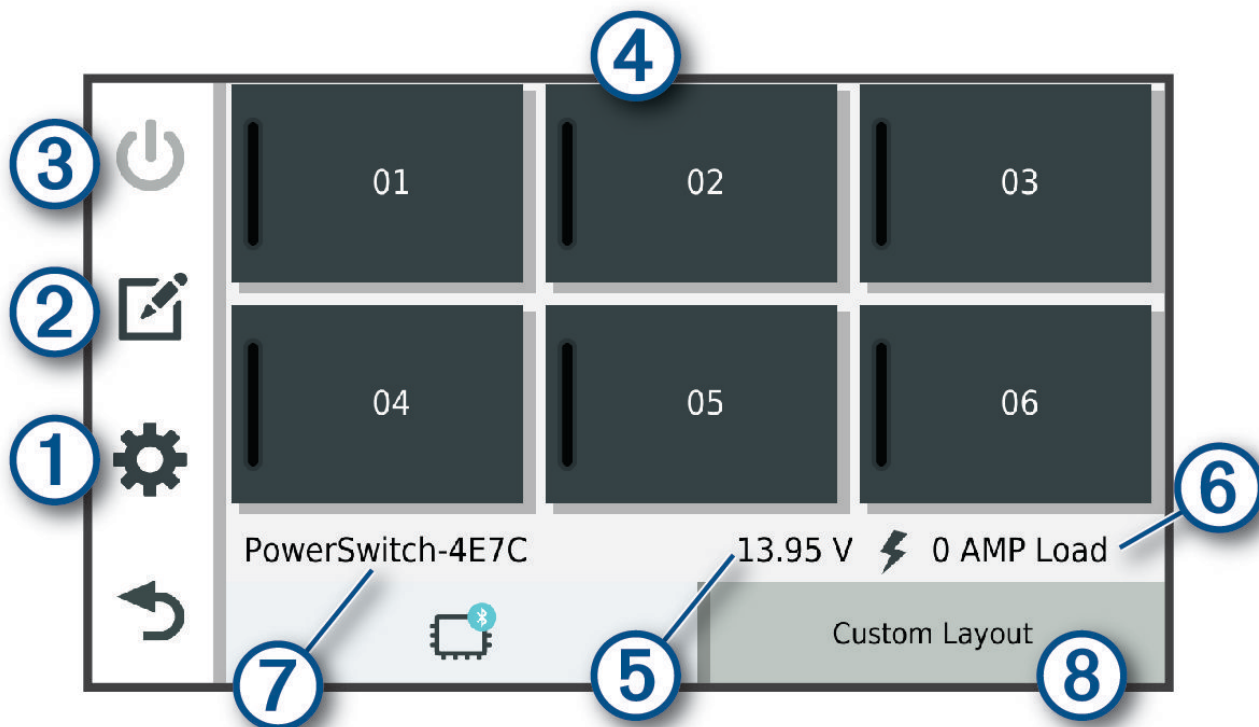
Garmin PowerSwitch™ App



① 	Opens the app settings menu
② 	Enters editing mode to customise the app layout and functions
③ 	Turns off all outputs
④ Power buttons	Activates each connected output
⑤	Displays input voltage
⑥	Displays the total amperage of the selected Garmin PowerSwitch device
⑦	Displays the device name
⑧	Displays Garmin PowerSwitch device tabs and custom layout tabs

Activating a Power Switch



Before you can use the Garmin PowerSwitch™ app to activate a switch, you must install your Garmin PowerSwitch device in your vehicle and pair it with the Garmin PowerSwitch app.

From the Garmin PowerSwitch app, select a power button to turn a switch on or off.

Turning Off All Switches

Select .

Customising a Button

- 1 From the Garmin PowerSwitch™ app screen, select .
The app enters editing mode.
- 2 Select  on the button you want to customise.
- 3 When you have finished customising the button, select .
- 4 Select **Done**.

Assigning a Switch to a Control Input



Before you can use control input functions, you must connect a control input to your Garmin PowerSwitch™ device.

You can assign one or more switches to turn on when the Garmin PowerSwitch device receives a signal from a control input.



- 1 Select .
- 2 Select your Garmin PowerSwitch device.
- 3 Select a control input.
- 4 Select one or more switches.

Adding a Custom Layout

You can add a custom layout tab to the Garmin PowerSwitch™ app. Buttons added to a custom layout can control multiple switches at the same time.

- 1 From the Garmin PowerSwitch app, select .
The device enters editing mode.
- 2 Select .

Adding a Button to a Custom Layout

- 1 From the Garmin PowerSwitch™ app, select a custom layout tab.
- 2 Select .
The app enters editing mode.
- 3 Select **Add Button**.
- 4 On the new button, select .
- 5 Select an option:
 - To change the name of the button, select the **Button Label** field and enter a name.
 - To add an icon to the button, select the **Icon** field and select an icon.
 - To change the button colour, select a colour.
- 6 Select **Add Action**.
- 7 If necessary, select a Garmin PowerSwitch device and a switch.
- 8 Select an action:
 - To set the button to turn the switch on or off with each press, select **Toggle**.
 - To set the button to turn on the switch, select **Turn On**.
 - To set the button to turn off the switch, select **Turn Off**.
- 9 Select a button mode:
 - To set the button to activate with one touch, select **Normal**.
 - To set the button to activate only while touching the button, select **Momentary**.
 - To set the button to turn on and off repeatedly, select **Strobe** and select time intervals.
- 10 If applicable, use the slider to set the brightness of lights.
- 11 Select .
- 12 If necessary, select **Add Action** to add additional actions to the button.
You can add one action for every switch on the Garmin PowerSwitch device.

Arranging Buttons In a Custom Layout

- 1 From the Garmin PowerSwitch™ app, select a custom layout tab.
- 2 Select .
The app enters editing mode.

3 On the button that you want to move, hold  and drag the button to a new location.



Deleting a Custom Layout or Button

1 From the Garmin PowerSwitch™ app, select a custom layout tab.

2 Select .

The app enters editing mode.

3 Select an option:

- To delete a button, select  on the button you want to delete.
- To delete a layout tab, select  on the layout tab.

Routines

Routines automate your Garmin PowerSwitch™ device. When you define a routine on your compatible Garmin® navigation device, it turns switches on or off automatically when the conditions of the routine are met. For example, you can set a routine to turn on a switch at specific time each day or when your vehicle reaches a specific speed. Routines are available only when using a compatible Garmin navigation device.

Adding a Routine

1 From the Garmin PowerSwitch™ app, select  > **Routines**.

2 If necessary, select **Add Routine**.

3 Select **When**.

4 Select a trigger:

- To set a switch to trigger when your vehicle reaches a specific speed, select **Speed** > **Next** and follow the on-screen instructions to enter speed thresholds.
- To set a switch to trigger at a specific time each day, select **Time** > **Next** and enter a time.
- To set a switch to trigger at sunrise, select **Sunrise**.
- To set a switch to trigger at sunset, select **Sunset**.

5 Select **Add Action**.

6 Select a device, a switch, an action and a button mode.

7 If necessary, use the slider to adjust the dimmer.

8 Select **Save**.

Editing a Routine

1 From the Garmin PowerSwitch™ app, select  > **Routines**.

2 Select on the routine you want to edit.

3 Select an option:

- To change the trigger for the routine, select **When** and select a trigger.
- To change an action, select on the action you want to change and update the action.
- To add an action to the routine, select **Add Action** and enter information about the action.

4 Select **Save**.

Deleting a Routine

1 From the Garmin PowerSwitch™ app, select  > **Routines**.

2 Select on the routine you want to delete.

Radio

NOTE: before you can use the Radio app, you must install a Group Ride accessory. Go to garmin.com to purchase a Group Ride accessory.

TIP: the Radio app is not available in all regions.

You can use the Radio app to create radio presets, select a radio channel and select squelch codes. To use this feature, you must connect the device and the antenna to the Group Ride mount. The zūmo® device configures radio settings automatically when you join or create a group ride.

Selecting a Preset

for some product models, the Radio app is located in the apps menu.

1 From the main menu, select  > **Radio**.

2 Select an option:

- To move through the available presets, select ▲ or ▼.
- To select a preset from the menu, select **Preset**.

Selecting a Radio Channel

- 1 From the main menu, select ■■ > **Radio**.
- 2 Select an option:
 - To move to a different channel, select + or —.
 - To select a MURS channel from the menu, select **Channel**.

Adjusting the Squelch

You can adjust the squelch and change between CTCSS, DCS and Open squelch modes to improve audio quality and avoid radio interference in your area.

- 1 From the main menu, select ■■ > **Radio**.
- 2 Select an option:
 - To choose a squelch code within the current mode, select + or —.
 - To adjust the squelch mode, select **Open**.

Adding a Custom Radio Preset

- 1 Select ■■ > **Radio** > **Preset** > ⊕.
- 2 Select + or — to select a channel and squelch code.
- 3 Select **Save**.

Selecting a Roger Tone

You can select the tone other devices play when you operate your radio.

- 1 Select ■■ > **Radio** > 📞 > **Roger Tone**.
- 2 Select a roger tone.
The device plays the selected tone.
- 3 Select **Save**.

Turning the Radio Off

Select ■■ > **Radio** > 🔌 > **Yes**.

Enabling Push-to-Talk with a Headset

You can enable push-to-talk controls for use with a compatible Bluetooth® headset. This allows you to transmit your voice using the voice dial feature on your headset.

- 1 Select ■■ > **Radio** > 📞 > **Push to Talk Over Headset**.
- 2 If necessary, follow the on-screen instructions to pair your headset with the device.
- 3 Select **Push to Talk Over Headset**.
- 4 Select ✓.

Transmitting Your Voice

Before you can transmit your voice, you must pair your zūmo® device with a compatible Bluetooth® headset or connect the fist microphone.

You can transmit your voice over the radio using the connected fist microphone or a compatible Bluetooth headset.

Select an option:

- Hold the push-to-talk button on the side of the connected fist microphone.
- From the main menu, select ■■ > **Radio** > **Push to Talk Over Headset**.
- Use the voice dial feature on your connected Bluetooth headset (*Enabling Push-to-Talk with a Headset*, page 46).



TIP: you can press the pause or stop button to manually close the radio.

you must enable the **Push to Talk Over Headset** setting to use this feature (*Radio Settings*, page 47).

Adjusting the Radio Volume

- 1 Select ■■ > **Radio** > 🔊).
- 2 Use the slider bars to adjust the volume.

Radio Settings

From the main menu, select  > **Radio** > .

Push to Talk Over Headset: enables you to transmit your voice using the push-to-talk button on your compatible headset.

Roger Tone: sets the roger tone the device plays when you operate your radio.

Reset Default Settings: resets all radio settings and presets to factory default values.

Group Ride

The Group Ride app allows you to coordinate rides and communicate with nearby riders using preset text messages, live map locations and voice communications. You can pair your zūmo® device with the Tread® app on your smartphone to enable Group Ride tracking features.

Voice communication and preset messaging require a Group Ride accessory, which is not included with all product models. The voice communication feature is not available in all areas. Go to garmin.com for more information or to purchase a Group Ride accessory.

Starting a Mobile Group Ride

Before you can start or join a mobile group ride, you must pair your zūmo® device with the Tread® app on your phone and your phone must have an active internet connection.

- 1 From the main menu, select **Group Ride**.
- 2 If necessary, enter your name and select **Done**.
- 3 Select **Start a Group Ride > Create a Mobile Group Ride**.
The ride ID and QR code appear.
- 4 Share the ride ID with other riders.
TIP: riders can use the Tread app to join your group ride by scanning the QR code.
- 5 Select **Start**.

Starting a Radio Group Ride

Before you can start or join a radio group ride, you must purchase and install a Group Ride accessory. You can go to buy.garmin.com to purchase a Group Ride accessory.

NOTE: voice communication during radio group rides is not available in certain regions.

- 1 From the main menu, select **Group Ride**.
- 2 If necessary, enter your name and select **Done**.
- 3 Select **Start a Group Ride > Create a Radio Group Ride**.
- 4 Select an option:
 - Select a radio preset.
 - Select a radio channel and squelch mode.
- 5 Select **Next**.
- 6 Enter the ride name and select **Done**.
As riders join your group ride, their names appear on the list.
- 7 After other riders have joined your group ride on their devices, select **Start**.

Joining a Group Ride

You can join a nearby group ride that was created by another rider.

- 1 From the main menu, select **Group Ride > Join a Group Ride**.
- 2 Enter the Ride ID and select **Done**.



Rejoining a Recent Group Ride

You can rejoin any of your ten most-recent group rides.

- 1 From the main menu, select **Group Ride > Recent Group Rides**.
- 2 Select a recent group ride and select **Join**.

Adding Riders to a Radio Group Ride

You can add riders to a radio group ride that is already in progress.

- 1 From the main menu, select  > **Group Ride**.
- 2 If necessary, select .

3 Select **Add**.

As new riders join the group ride, they appear on the list.

4 Select **Continue**.

Broadcasting a Message

⚠ WARNING

Do not read, send or reply to any messages while driving. If you do so, you could become distracted by the display, which could lead to an accident causing personal injury or death.

You can broadcast a preset message to the members in your active group ride that are in range of the VHF radio.

1 From the main menu, select **Group Ride**.

2 If necessary, select .

3 Select **Broadcast to Group**.

4 Select a preset message and select **Send**.

Broadcasting a Location

⚠ WARNING

While driving, do not interact with the display to broadcast your location. If you do so, you could become distracted by the display, which could lead to an accident causing serious personal injury or death.

You can broadcast a location to the members in your active group ride that are in range of the VHF radio.

1 From the main menu, select **Group Ride**.

2 If necessary, select .

3 Select **Broadcast to Group > Broadcast a Location** and select a location.

4 Select **Share**.

Viewing a Group Ride Notification

⚠ WARNING

Do not read or reply to any notifications while driving. If you do so, you could become distracted by the display, which could lead to an accident causing serious personal injury or death.

From most pages, a notification appears when the device receives a broadcasted group ride location or message. You can also view group ride notifications in the Group Ride app.

when you are viewing the map, new notifications appear in a map tool at the edge of the screen..

1 From the main menu, select **Group Ride >** and select a notification.

2 Select **Go!** to navigate to a shared location.

Exiting a Group Ride

1 From the main menu, select **Group Ride**.

2 If necessary, select .

3 Select **Exit > Yes**.

Group Ride Settings

From the main menu, select **Group Ride > **.

Edit Rider Name: allows you to set your name that displays during a group ride. This setting is not available during an active group ride.

Rider Map Labels: sets the label displayed for each active rider on the map.





Show Tracks on Map: shows the track that each group ride member takes on the map.

Reset Default Settings: allows you to reset all group ride settings to default values. This setting is not available during an active group ride.

Handlebar Controller

The Handlebar Controller app allows you to view and configure the actions triggered by each button on the Handlebar Controller accessory.

By default, the handlebar controller buttons trigger the following actions.

	Short press to save the current location. Long press to skip the next destination on your route.
	Press to zoom in on the map.
	Press to zoom out on the map.
	Short press to change the map type. Long press to lock or unlock the screen.

In addition to the user-configurable actions, you can press the **+** and **-** buttons to interact with on-screen dialogues.

Configuring the Buttons

You can configure each button on the handlebar controller to trigger different actions.

1 Select > **Handlebar Controller**.

A diagram of the handlebar controller appears. Each button is linked to a short press action and a long press action.

2 Select **Short Press** to choose the action to trigger with a short press of the linked button.

Some actions, such as zooming in or out on the map, must trigger with both a short press or a long press and will automatically be set for both modes.

3 Select an action.

4 Select .

5 Select **Long Press** to choose the action to trigger with a long press of the linked button.

6 Select .

7 Repeat steps 2 through 6 for each of the buttons.

You can select  > **Restore** to set all the handlebar controller buttons back to their default configuration.

Wireless Cameras

Your device can display the video feed from one or more connected wireless cameras (sold separately).

Pairing the Device with a Wireless Camera

You can pair a wireless camera with your zūmo® device.

1 Update your zūmo device to the latest software version ([Map and Software Updates, page 59](#)).

Your device may not support the wireless camera without the latest software.

2 Select > **Cameras** > **Add New Camera**.

3 Follow the on-screen instructions to finish pairing and setting up the camera.

After you complete the pairing process with a camera for the first time, it connects automatically to the Garmin® navigation device when power is applied.

Viewing the Wireless Camera

WARNING

This device is intended to enhance situational awareness when used properly. If used improperly, you could become distracted by the display, which could lead to an accident causing serious personal injury or death. Always view the display at a glance when the vehicle is in motion to avoid becoming distracted.

Select  > **Cameras**.

Aligning the Guidance Lines

For the best reference points, the guidance lines should be aligned to reflect the outside edges of the vehicle. You should align the guidance lines separately for each backup camera. On some models, adjustment is automatically available after pairing a camera.



WARNING

You must ensure that the guidance lines are properly aligned before using the device and after making any camera angle adjustments. Failure to properly align the guidance lines could result in an accident or collision, resulting in death, serious injury or property damage.

1 Position the vehicle with one side closely aligned to a kerb, driveway or parking stall lines.

You may want to position the vehicle in the centre of a parking stall and then pull forwards into the next stall. This allows you to use the parking stall lines at the rear of the vehicle as reference points for alignment. The kerb, driveway or parking stall lines should be clearly visible on the device.

2 Select an option:

- From the camera view, tap the screen and select .
- From the camera view, select  > **Adjust Video**.

3 Drag the circles on the corners of the guidance lines , or tap the arrows until they match the angle and position of the kerb, driveway or parking stall lines.

The guidance lines should appear directly on top of your reference points.

The red or orange section of the guidance lines should align with the rear of your vehicle.

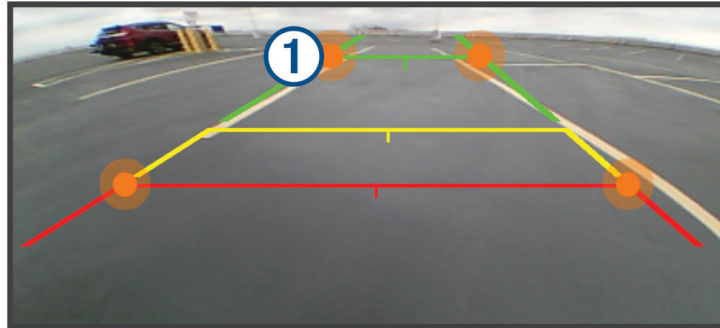

4 If necessary, reposition the vehicle with the other side closely aligned to a kerb, driveway or parking stall lines, and repeat the alignment process.

You should attempt to keep the guidance lines symmetrical, even if your vehicle is not in perfect alignment with the kerb, driveway or parking stall lines.

5 Select  after alignment is complete.

Great Rides

WARNING

This feature allows you to follow rides and routes generated by third parties. Garmin® makes no representations about the accuracy, reliability, completeness or timeliness of routes generated by third parties. Any use or reliance on such routes is at your own risk.

You can use the Great Rides feature to bookmark and navigate popular rides. You can rate rides and share photos using the Tread® app on your smartphone.

Bookmarking a Ride

You can view and bookmark rides using the Tread® app on your smartphone. Bookmarked rides automatically sync with your zūmo® navigator while it is connected to the Tread app.

1 From the Tread app on your smartphone, select  > **Great Rides**.

2 Select an option:

- To view a list of popular rides in your region, select **Top Rides**.
- To view a list of nearby rides, select **Nearby**.

3 Select a ride.

4 Select **Add Bookmark**.

Synchronising Great Rides

Bookmarked rides synchronise automatically when you open the Great Rides app on your zūmo® navigator while you are connected to the Tread® app on your smartphone. You can also synchronise data manually at any time.

1 Select  > **Great Rides**.

2 If necessary, select .

Navigating a Bookmarked Ride

Before you can navigate to a bookmarked ride, you must synchronise the Great Rides app on your zūmo® navigator with the Tread® app on your smartphone (*Synchronising Great Rides, page 50*).

- 1 Select  > **Great Rides**.
- 2 Select a ride.
- 3 Select the starting point for your ride, and select **Go!**.
- 4 Select the next destination, and select **OK**.
The device calculates a route to the starting point you selected.
- 5 Select **Start**.

After you navigate a bookmarked ride, you can rate the ride and share photos using the Tread app on your smartphone.

Music Player

The music player can play music or audio from these sources.

- Music files stored on your zūmo® device.
- Bluetooth® audio from a paired phone.

Adding the Music Player Tool to the Map

The music player map tool enables you to control the music player from your map.

- 1 Open the map.
- 2 Select  > **Music Player**.
The music player controls appear on the map.

Changing the Media Source

You can change the source from which media is played on your device.

- 1 Select **Music**.
- 2 Select the current media source .



- 3 Select an available media source from the list.

Tracks

A track is a recording of your path. The track log contains information about the recorded path, including time, location, and elevation information.

Recording Tracks

Tracking records your path. When you start tracking, your device logs your location and updates the track.

- 1 Select  > **Track Recorder**.
- 2 Select **Start**.

If your device is paired with the Tread® app, recorded tracks are periodically synchronised to your Garmin® account.

You can retrace your recorded track by navigating it as a new route.

TracBack®



Following your recent track

The TracBack® feature records the most recent segment of your movement. You can retrace your recent track back to a previous location.

- 1 Select  > **TracBack**.
Your recent track appears on the map.
- 2 Select **Go!**.



Saving Your Recent Track as a Route

You can save your recent track as a route, which you can navigate later using the route planner.



- 1 Select  > **TracBack**.
Your recent track appears on the map.
- 2 Select  > **Save as Route**.
- 3 Enter a name for the route and select **Done**.

Viewing traffic on the map

The traffic map shows colour-coded traffic flow and delays on nearby roads.

- 1 From the main menu, select  > **Traffic**.
- 2 If necessary, select  > **Legend** to view the legend for the traffic map.

Searching for traffic incidents

- 1 From the main menu, select  > **Traffic**.
- 2 Select  > **Incidents**.
- 3 Select an item in the list.
- 4 If there is more than one incident, use the arrows to view additional incidents.

Viewing the Weather Forecast

NOTICE

Garmin® is not responsible for the accuracy or timeliness of the weather data.



Before you can use this feature, your device must be receiving weather data. You can connect your device to the Tread® app to receive weather data (*Pairing with Your Smartphone, page 37*).

NOTE: weather forecasts are not available in all areas.

- 1 Select  > **Weather**.
The device shows the current weather conditions and a forecast for the next several days.
- 2 Select a day.
The detailed forecast for that day appears.

Viewing the weather radar

Before you can use this feature, your device must be connected to a supported phone running the Tread® app (*Pairing with Your Smartphone, page 37*).

- 1 Select  > **Weather Radar**.
- 2 Select  to animate the radar map.

Viewing Previous Routes and Destinations

Before you can use this feature, you must enable the travel history feature (*Device and privacy settings, page 55*).

You can view your previous routes and places where you have stopped on the map.

Select  > **Where I've Been**.

Settings

Phone and Headset Settings

Phone settings

Select  > **Phone** and select your phone.

Disconnect: disconnects the paired phone.

Phone Name: displays the name of the paired phone. You can select the name to change how it displays on your navigation device.

Phone Call Controls: enables phone controls when receiving a phone call.

Media Audio: enables the navigation device to play media audio from your paired phone.

Garmin Tread: displays the connection status to the Tread® app on your phone.

Forget Device: removes the connected device from the list of paired devices. This option is available only after a device is paired.

Headset Settings

Select  > **Headphone** and select your headset.

Disconnect: disconnects the paired headset.

Headset Name: displays the name of the paired headset. You can select the name to change how it appears on your navigation device.

Navigation Audio Quality: sets the audio quality for navigation prompts.

Headphone: enables or disables headset features.

Media Audio: enables or disables media audio through the headset.

Forget Device: removes the headset from the list of paired devices.

Wi-Fi® settings

The wireless network settings allow you to manage Wi-Fi networks.

Select  > **Wi-Fi**.

Wi-Fi: enables the Wi-Fi radio.

Saved Networks: allows you to edit or remove saved networks.

Search for Networks: searches for nearby Wi-Fi networks ([Connecting to a Wi-Fi® Network, page 59](#)).

Map settings

Select  > **Map**.

Map Vehicle Icon: sets the vehicle icon that represents your position on the map.

Driving Map View: sets the navigational perspective on the map.

Map Detail: sets the level of detail on the map. More detail may cause the map to be drawn more slowly.

Waypoint Labels: sets the size of waypoint labels on the map.

Waypoint Decluttering: hides waypoints at high map zoom levels.

Large Navigation Text: enables enlarged navigation text.

Auto Zoom: automatically selects the zoom level for optimal use of your map. When disabled, you must zoom in or out manually.

Skip Next Stop Confirmation: sets a confirmation message to appear when skipping a location on your route.

Map Manager: manages maps installed on the device ([Downloading Outdoor Maps+ Content, page 27](#)).

Navigation settings

Select  > **Navigation**.

Vehicle Settings: sets routing options and other options for your current vehicle profile.

Off-Route Recalculation: sets recalculation preferences when navigating away from an active route.

Custom Avoidances: allows you to avoid specific roads or areas.

Traffic: sets options for traffic features ([Traffic Settings, page 54](#)).

Restricted Mode: disables all functions that require significant operator attention.

GPS Simulator: stops the device from receiving a GPS signal and saves battery power.

Traffic Settings

From the main menu, select  > **Navigation** > **Traffic**.

Traffic: enables traffic.

Optimise Route: enables the device to use optimised alternative routes automatically or upon request (*Avoiding traffic delays on your route, page 23*).

Setting a simulated location

If you are indoors or not receiving satellite signals, you can use the GPS simulator to plan routes from a simulated location.

- 1 Select  > **Navigation** > **GPS Simulator**.
- 2 From the main menu, select **View Map**.
- 3 Tap the map twice to select an area.
The address of the location appears at the bottom of the screen.
- 4 Select the location description.
- 5 Select **Set Location**.

Driver Assistance Settings

Select  > **Driver Assistance**.

Rider Alerts: allows you to enable or disable alerts for upcoming zones or road conditions (*Rider Awareness Features and Alerts, page 14*).

Speeding Alert: alerts you when you are exceeding the speed limit.

Reduced Speed Tone: alerts you when the speed limit decreases.

Ride Summary: displays a summary of your ride at the end of a route.

Local Spots: displays attractions near the destination.

Helmet Guide: displays changes for helmet requirements when crossing borders.

Country Border Alert: displays a notification when crossing international borders.

Route Preview: displays a preview of the major roads on your route when you start navigation.

Break Planning: reminds you to take a break, and displays upcoming services after you drive for an extended time. You can enable or disable break reminders and upcoming service suggestions.

Automatic Incident Detection: enables the navigator to detect incidents and to notify emergency contacts when the navigator detects an incident (*Incident Detection and Notifications, page 14*).

Incident Messaging: alerts your emergency contacts if an incident is detected (*Incident Detection and Notifications, page 14*).

Display settings

Select  > **Display**.

Brightness Slider: you can move the slider to adjust the display brightness.

Orientation: allows you to set the display to portrait (vertical) or landscape (horizontal). If you select the Auto option, the display automatically switches orientation based on the physical orientation of the device.

Colour Mode: allows you to select day or night colour mode. If you select the Auto option, the device automatically switches to day or night colours based on the time of day.

Display Timeout: allows you to set the amount of idle time before your device enters sleep mode while using battery power.

Screenshot: allows you to take a picture of the device screen. Screenshots are saved in the Screenshot folder of the device storage.

System Settings

Select  > **System**.

Voice Language: sets the language for voice prompts.

Text Language: sets all on-screen text to the selected language.

NOTE: changing the text language does not change the language of user-entered data or map data, such as street names.

Keyboard Language: enables keyboard languages.

Units: sets the unit of measure used for distances.

Current Time: sets the device time.

Time Format: allows you to select a 12-hour, 24-hour or UTC display time.

Position Format: sets the coordinate format and datum used for geographical coordinates.

Position Format Settings

NOTE: do not change the position format or the map datum coordinate system unless you are using a map or chart that specifies a different position format.

Select  > **System** > **Position Format**.

Coordinate Format: sets the position format for the location information.

Display Format: sets the format in which coordinates will appear on the device.

Datum: sets the coordinate system on which the map is structured.

Map Spheroid: shows the coordinate system the device is using. The default coordinate system is WGS 84.

Setting the Time

1 From the main menu, select the time.

2 Select an option:

- To set the time automatically using GPS information, select **Automatic**.
- To set the time manually, drag the numbers up or down.

Device and privacy settings

Select  > **Device**.

About: displays the software version number, the unit ID number and information on several other software features.

Screen Lock: sets options to require a Personal Identification Number (PIN) each time you turn on the navigator ([Enabling the Screen Lock, page 55](#)).

Regulatory: displays regulatory markings and information.

EULAs: displays the end-user licence agreements.

NOTE: you need this information when you update the system software or purchase additional map data.

Software Licences: displays software licensing information.

Device Data Reporting: shares anonymous data to improve the device.

Travel History: allows the device to store a record of the places you go. This allows you to view the trip log, use the Trip History feature and use myTrends™ suggested routes.

Reset: allows you to clear your travel history, reset settings or delete all user data.

Enabling the Screen Lock

To prevent unauthorised use of your device, you can enable the Screen Lock feature, which requires a Personal Identification Number (PIN). When enabled, you must enter the PIN to unlock the screen each time you turn on the device.

NOTICE

If you enable the Screen Lock feature, Garmin® Support cannot retrieve the PIN or access your device. It is your responsibility to provide the PIN to anyone authorised to use the navigator.

1 Select  > **Device** > **Screen Lock**.

2 Select an option:

- To enable the screen lock and set a new PIN, select **Require PIN** and enter a PIN number.
- To change your PIN number, select **Change PIN** and enter a PIN number.
- To disable the screen lock, clear the **Require PIN** tick box.

Restoring settings

You can restore a category of settings or all settings to the factory default values.

1 Select .

2 If necessary, select a settings category.

3 Select  > **Restore**.

Data management

The device has a memory card slot for additional data storage.

NOTE: the device is compatible with Windows® 7 and newer, and Mac® OS 10.7 and newer.

About Memory Cards

You can purchase memory cards from an electronics supplier or purchase pre-loaded Garmin mapping software (www.garmin.com). Memory cards can be used to store files such as maps and POIs.

Installing a memory card for maps and data

You can install a memory card to increase the storage space for maps and other data on your device. You can purchase memory cards from an electronics supplier. Memory cards must use the exFAT file system format.

- 1 Locate the map and data memory card slot on your device (*zūmo® XT3 - 6 in. Device Overview, page 6*).
- 2 Insert a memory card into the slot.
- 3 Press it in until it clicks.

Connecting the Device to Your Computer

You can connect the device to your computer using a USB cable.

- 1 Plug the small end of the USB cable into the port on the device.
- 2 Plug the larger end of the USB cable into a port on your computer.
- 3 From your zūmo® device, select **Tap to Connect to Computer**.

A picture of your device connected to a computer appears on the device screen.

Depending on your computer operating system, the device appears as either a portable device, a removable drive, or a removable volume.

Transferring GPX Files From Your Computer

Apple® computers may require additional third-party software, such as Android File Transfer, to read and write files on this device.

If you have already created routes that you want to use on your device, you can transfer GPX files directly from your computer.

- 1 Connect the device to your computer (*Connecting the Device to Your Computer, page 56*).
The device appears as a portable device.
- 2 On your computer, open the file browser.
- 3 Select a GPX file.
- 4 Select **Edit > Copy**.
- 5 Browse to the GPX folder on the device.
- 6 Select **Edit > Paste**.

Transferring data from your computer

- 1 Connect the device to your computer (*Connecting the Device to Your Computer, page 56*).
Depending on your computer operating system, the device appears as either a portable device, a removable drive, or a removable volume.
- 2 On your computer, open the file browser.
- 3 Select a file.
- 4 Select **Edit > Copy**.
- 5 Browse to a folder on the device.
NOTE: for a removable drive or volume, you should not place files in the Garmin folder.
- 6 Select **Edit > Paste**.

Disconnecting the USB cable

If your device is connected to your computer as a removable drive or volume, you must safely disconnect your device from your computer to avoid data loss. If your device is connected to your Windows® computer as a portable device, it is not necessary to safely disconnect the device.

- 1 Complete an action:

- For Windows computers, select the **Safely Remove Hardware** icon in the system tray and select your device.
 - For Apple® computers, select the device, and select **File > Eject**.
- 2 Disconnect the cable from your computer.

Device information

Viewing E-label Regulatory and Compliance Information

- 1 From the settings menu, swipe to the bottom of the menu.
- 2 Select **Device > Regulatory**.

Specifications

Water resistance	IEC 60529 IPX7 ¹
Operating temperature range	From -15° to 55°C (from 5° to 131°F)
Charging temperature range	From 0° to 45°C (from 32° to 113°F)
Power input (vehicle power cable, motorcycle or external power)	From 12 to 18 Vdc
Battery type	Lithium-ion battery
Battery voltage range	From 3.5 to 4.2 V
EU wireless frequencies and transmit power	2400 - 2483,5 MHz: < 20dBm 5150 - 5250 MHz: < 23dBm 5250 - 5350 MHz: < 23dBm 5470 - 5725 MHz: < 23dBm 5725 - 5850 MHz: < 23dBm
EU SAR	A05115: < 0,411 W/kg limb, < 0,411 W/kg torso A05116: < 0,429 W/kg limb, < 0,429 W/kg torso

Charging the Device

NOTE: this Class III product shall be powered by an LPS power supply.

You can charge the battery in the device using any of these methods.

- Install the device in the mount, and connect the mount to vehicle power.

NOTICE

Do not connect the device directly to the vehicle power cable.

- Connect the device to an optional power adapter accessory, such as a wall power adapter.
You can purchase an approved Garmin® AC-DC adapter suitable for home or office use from a Garmin dealer or www.garmin.com. The device may charge slowly when connected to a third-party adapter.

¹ *The device withstands incidental exposure to water of up to 1 m for up to 30 min. For more information, go to www.garmin.com/waterrating.

Device maintenance

Garmin® Support Centre

Go to support.garmin.com for help and information, such as product manuals, frequently asked questions, videos and customer support.

Map and Software Updates

For the best navigation experience, you should keep the maps and software on your device up to date.

Map updates provide the newest available changes to roads and locations in the maps used by your device. Keeping maps up to date helps your device find recently added locations and calculate more accurate routes. Map updates are large and may take several hours to complete.

Software updates provide changes and improvements to the device features and operation.

You can update your device using two methods.

- You can connect the device to a Wi-Fi® network to update directly on the device (recommended). This option allows you to update your device conveniently without connecting it to a computer.
- You can connect the device to a computer and update it using the Garmin Express™ application (garmin.com/express).



Updating Maps and Software Using a Wi-Fi® Network

NOTICE

Map and software updates may require the device to download large files. Regular data limits or charges from your internet service provider apply. Contact your internet service provider for more information about data limits or charges.

You can update the maps and software by connecting your device to a Wi-Fi network that provides access to the internet. This allows you to keep your device up to date without connecting it to a computer.

- 1 Connect the device to a Wi-Fi network ([Connecting to a Wi-Fi® Network, page 59](#)).

While connected to a Wi-Fi network, the device checks for available updates. When an update is available,  appears on the  icon in the main menu.

- 2 Select  > **Updates**.

The device checks for available updates. When an update is available, **Update Available** appears below Map or Software.

- 3 Select an option:

- To install all available updates, select **Install All**.
- To install only map updates, select **Map > Install All**.
- To install only software updates, select **Software > Install All**.

- 4 Read the licence agreements, and select **Accept All** to accept the agreements.

NOTE: if you do not agree with the licence terms, you can select **Reject**. This stops the update process. You cannot install updates until you accept the licence agreements.

- 5 Using the included USB cable, connect the device to external power, and select **Continue** ([Charging the Device, page 58](#)).

For the best results, a USB wall charger that provides at least 2 A power output is recommended. Many USB power adapters for smartphones, tablets or portable media devices may be compatible.

- 6 Keep the device connected to external power and within range of the Wi-Fi network until the update process is complete.

TIP: if a map update is interrupted or cancelled before it completes, your device may be missing map data. To repair missing map data, you must update the maps again using either Wi-Fi or Garmin Express™.

Connecting to a Wi-Fi® Network

The first time you turn on the device, it prompts you to connect to a Wi-Fi network. You can also connect to a Wi-Fi network using the settings menu.

- 1 Select  > **Wi-Fi**.

- 2 If necessary, select **Wi-Fi** to enable Wi-Fi technology.

- 3 Select **Search for Networks**.

The device displays a list of nearby Wi-Fi networks.

- 4 Select a network.

5 If necessary, enter the password for the network, and select **Done**.

The device connects to the network, and the network is added to the list of saved networks. The device reconnects to this network automatically when it is within range.

Updating Maps and Software with Garmin Express™

You can use the Garmin Express application to download and install the latest map and software updates for your device.

1 If you do not have the Garmin Express application installed on your computer, go to garmin.com/express and follow the on-screen instructions to install it.

2 Open the  Garmin Express application.

3 Connect your device to your computer using a USB cable.

The small end of the cable connects to the USB port  on your zūmo® device, and the large end connects to an available USB port on your computer.

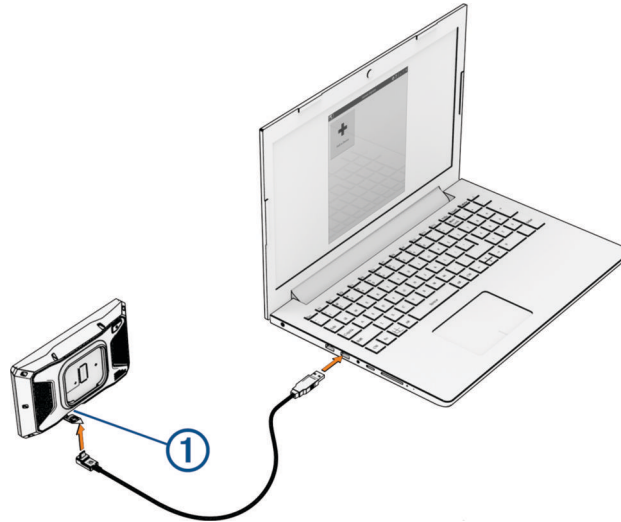

4 From your zūmo device, select **Tap to Connect to Computer**.

5 In the Garmin Express application, click **Add a Device**.

The Garmin Express application searches for your device and displays the device name and serial number.

6 Click **Add Device** and follow the on-screen instructions to add your device to the Garmin Express application. When setup is complete, the Garmin Express application displays the updates available for your device.

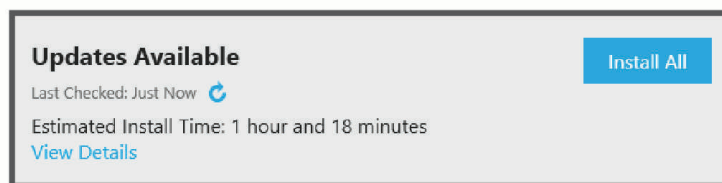

7 Select an option:

- To install all available updates, click **Install All**.
- To install a specific update, click **View Details** and click **Install** next to the update you want.

The Garmin Express application downloads and installs the updates onto your device. Map updates are very large and this process may take a long time on slower internet connections.

NOTE: if a map update is too large for the internal storage of the device, the software may prompt you to install a microSD® card in your device to add storage space (*Installing a memory card for maps and data*, page 56).

8 Follow the on-screen instructions during the update process to finish installing updates.

For example, during the update process, the Garmin Express application may instruct you to disconnect and reconnect your device.

Device Care

NOTICE

Avoid dropping your device.

Do not store the device where prolonged exposure to extreme temperatures can occur, as it can cause permanent damage.

Never use a hard or sharp object to operate the touchscreen as this may result in damage.

Cleaning the outer casing

NOTICE

Avoid chemical cleaners and solvents that can damage plastic components.

- 1 Clean the outer casing of the device (not the touchscreen) using a cloth dampened with a mild detergent solution.
- 2 Wipe the device dry.

Cleaning the Touchscreen

- 1 Use a soft, clean, lint-free cloth.
- 2 If necessary, lightly dampen the cloth with water.
- 3 If using a dampened cloth, turn off the device and disconnect the device from the power.
- 4 Gently wipe the screen with the cloth.

Restarting the Device

You can restart your device if it stops functioning.

Hold the power button for 12 seconds.

Troubleshooting

My device is not acquiring satellite signals

- Verify the GPS simulator is turned off ([Navigation settings, page 53](#)).
- Take your device out of multi-storey car parks and away from tall buildings and trees.
- Remain stationary for several minutes.

My device does not connect to my phone

- Select  > **Phone**, and verify that your phone is paired with the navigator.
- Enable Bluetooth® wireless technology on your phone, and bring your phone within 10 m (33 ft.) of the device.
- Verify your phone is compatible.
Go to www.garmin.com/bluetooth for more information.
- Complete the pairing process again.

To repeat the pairing process, you must unpair your phone and device ([Disconnecting a Bluetooth® device, page 39](#)), and complete the pairing process ([Pairing with Your Smartphone, page 37](#)).

My device is not contacting my emergency contact

WARNING

The device allows you to send your location to an emergency contact. This is a supplementary feature and should not be relied upon as a primary method to obtain emergency assistance. The Tread® app does not contact emergency services on your behalf.

If your device is not contacting your emergency contact, you can try these options.

- Verify that the zūmo® navigator is connected to a compatible external power source, such as the included mount or using a USB cable ([Installation, page 9](#)).
- Verify that the zūmo navigator is connected to the Tread app on your smartphone using Bluetooth® wireless technology ([Pairing with Your Smartphone, page 37](#)).
- Verify that your smartphone is in an area of network coverage where data connectivity is available.
- Verify that the **Automatic Incident Detection** feature and the **Incident Messaging** feature are enabled on your zūmo navigator ([Driver Assistance Settings, page 54](#)).
- Verify that you have set up an emergency contact using the Tread app on your smartphone ([Setting Up an Emergency Contact, page 15](#)).
- Verify that the incident contact's phone is capable of receiving text messages or email.

My battery does not stay charged for very long

- Decrease the screen brightness ([Display settings, page 54](#)).
- Shorten the display timeout ([Display settings, page 54](#)).
- Decrease the volume ([Adjusting the volume, page 8](#)).
- Turn off the Wi-Fi radio when it is not in use ([Wi-Fi® settings, page 53](#)).
- Put the device in power saving mode when not in use ([Turning the device on or off, page 7](#)).
- Keep your device away from extreme temperatures.
- Do not leave your device in direct sunlight.

The suction cup will not stay on my windscreen

- 1 Clean the suction cup and windscreen with surgical spirit.
- 2 Dry with a clean, dry cloth.
- 3 Mount the suction cup ([Mounting Your Device in a Vehicle, page 12](#)).

My device does not appear as either a portable device or a removable drive or volume on my computer

- 1 Disconnect the USB cable from your computer.
- 2 Turn off the device.
- 3 Connect the USB cable to your device and to a USB port on your computer.

TIP: the USB cable must connect to a USB port on your computer, not to a USB hub.

The device turns on automatically and goes into MTP mode or USB mass storage mode. A picture of the device connected to a computer appears on the device screen.

if you have several network drives mapped on your computer, Windows® may have trouble assigning drive letters to your Garmin® drives. For information about assigning drive letters, see the help file for your operating system.

support.garmin.com

© 2026 Garmin Ltd. or its subsidiaries

Garmin®, the Garmin logo, zūmo®, inReach®, TracBack® and Tread® are trademarks of Garmin Ltd. or its subsidiaries, registered in the USA and other countries. Garmin Adventurous Routing™, Garmin Catalyst™, Garmin Express™, Garmin Messenger™, Garmin Performance Package™, Garmin PowerSwitch™ and myTrends™ are trademarks of Garmin Ltd. or its subsidiaries. These trademarks may not be used without the express permission of Garmin.

Apple® and Mac® are trademarks of Apple Inc., registered in the U.S. and other countries and regions. The Bluetooth® word mark and logos are owned by the Bluetooth SIG, Inc., and any use of such name by Garmin is under licence. microSD® and the microSD logo are trademarks of SD-3C, LLC. Tripadvisor® is a registered trademark of TripAdvisor LLC. USB-C® is a registered trademark of USB Implementers Forum. Windows® is a registered trademark of Microsoft Corporation in the United States and other countries. Wi-Fi® is a registered trademark of Wi-Fi Alliance. Other trademarks and trade names are those of their respective owners.